

Womanizer

THE ORIGINAL



CLASSIC 2

MANUAL / MODE D'EMPLOI / BEDIENUNGSANLEITUNG /
MANUAL DE INSTRUCCIONES / GEBRUIKSAANWIJZING /
NÁVOD K OBSLUZE / ИНСТРУКЦИЯ ПО ЭКСПЛУАТАЦИИ /
INSTRUKCJA OBSŁUGI / BRUKSANVISNING / MANUAL DE
OPERAÇÃO / ISTRUZIONI PER L'USO / BRUGSANVISNING /
BRUKSANVISNING / 操作说明 / 사용 설명서 / 快速入门用户指南 /
取扱説明書

Languages

ENGLISH

FRANCAIS

DEUTSCH

ESPAÑOL

NEDERLANDS

ČEŠTINA

РУССКИЙ

POLSKI

SVENSKA

PORTUGUÊS

ITALIANO

DANSK

NORSK

中文

한국어

繁體中文

にほんご

Hi!

Thank you for choosing Womanizer!

Welcome to a world full of sensual experiences that will enrich your life. By choosing WOMANIZER, you are not only guaranteed orgasms that are beyond comparison – but also an entirely new lust for pleasure.

Enjoy your WOMANIZER - one orgasm after another.

Go, love yourself!



PRODUCT DESCRIPTION

HOW TO USE

CHARGING

CLEANING

GENERAL INFORMATION

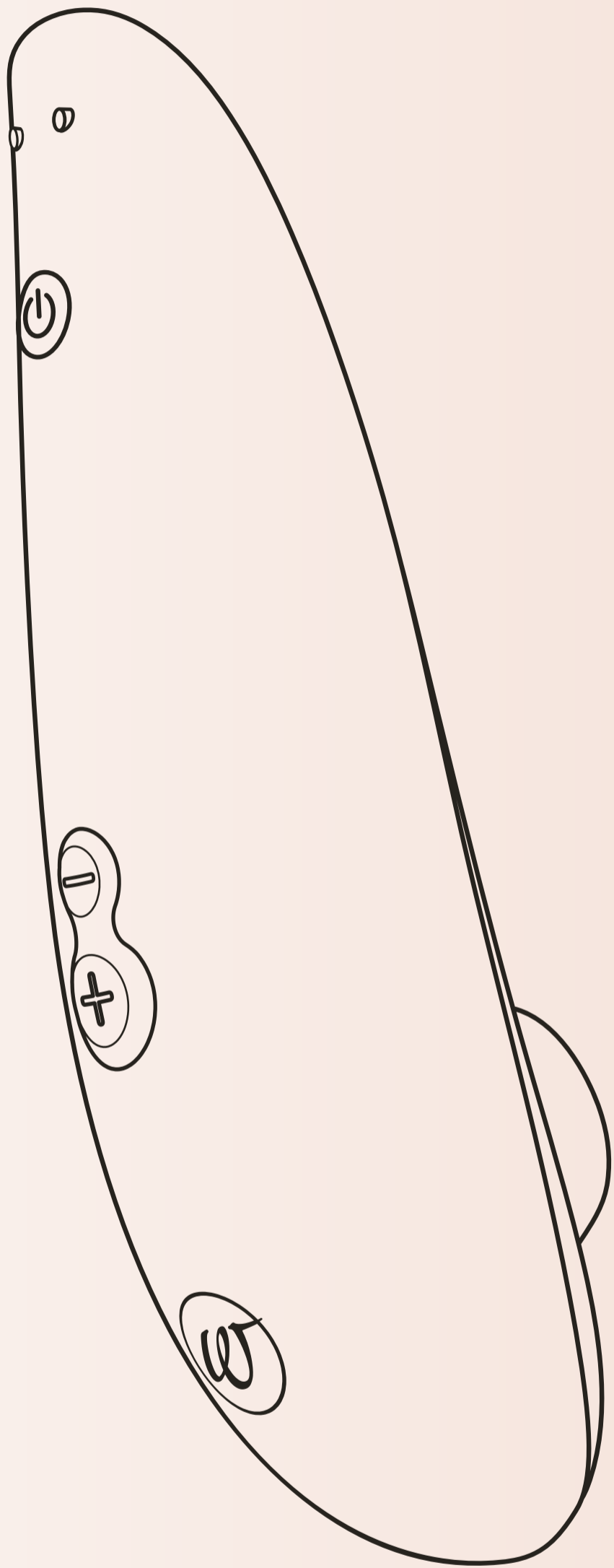

PRODUCT DESCRIPTION

Magnetic Charging Pins

On/Off
press for 2 sec

Afterglow Feature
press briefly

Decrease Intensity
press briefly

Increase Intensity
press briefly

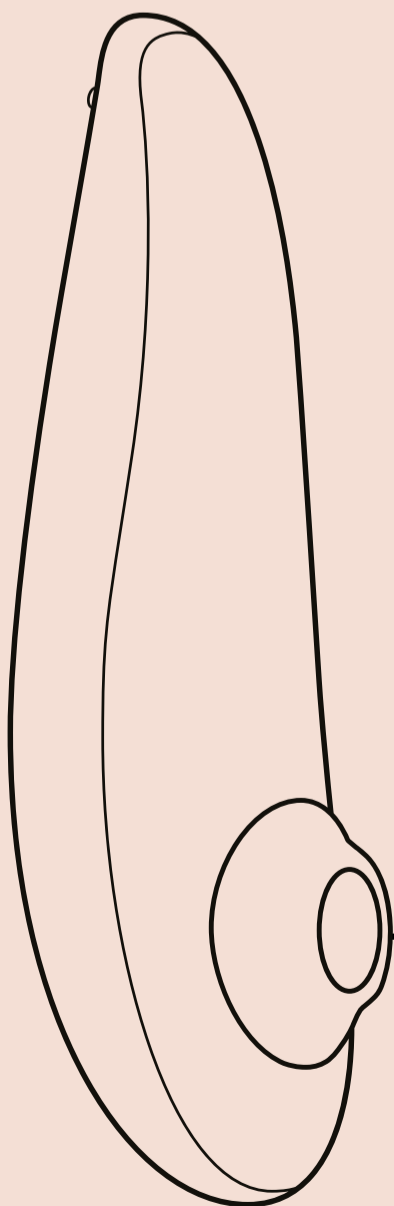
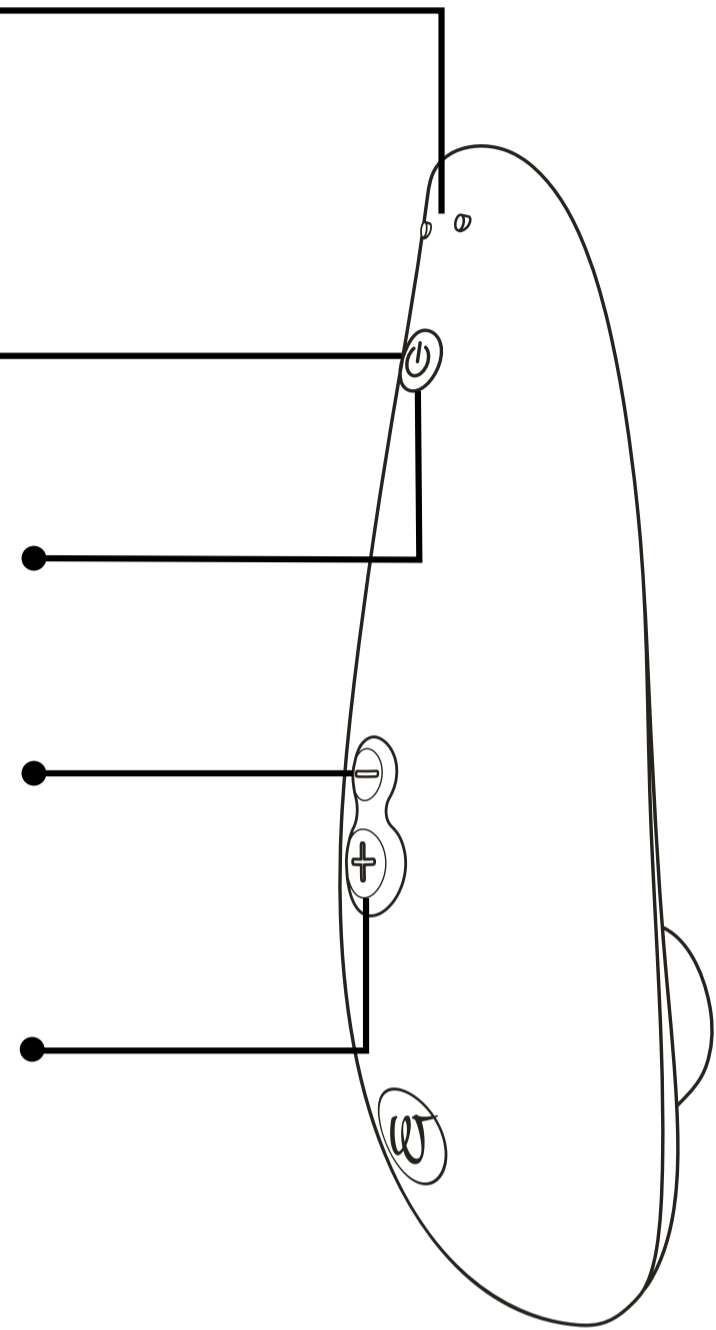

Stimulation Head

HOW TO USE

1. Turn on

press for
2 seconds

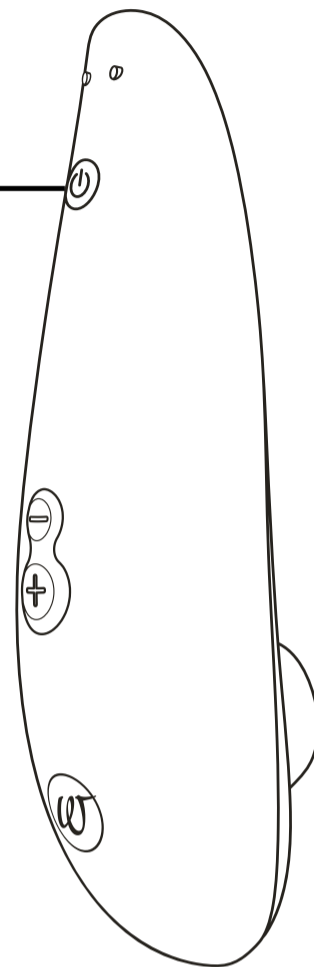

2. Usage

Surround your clitoris with the stimulation head and your journey begins.

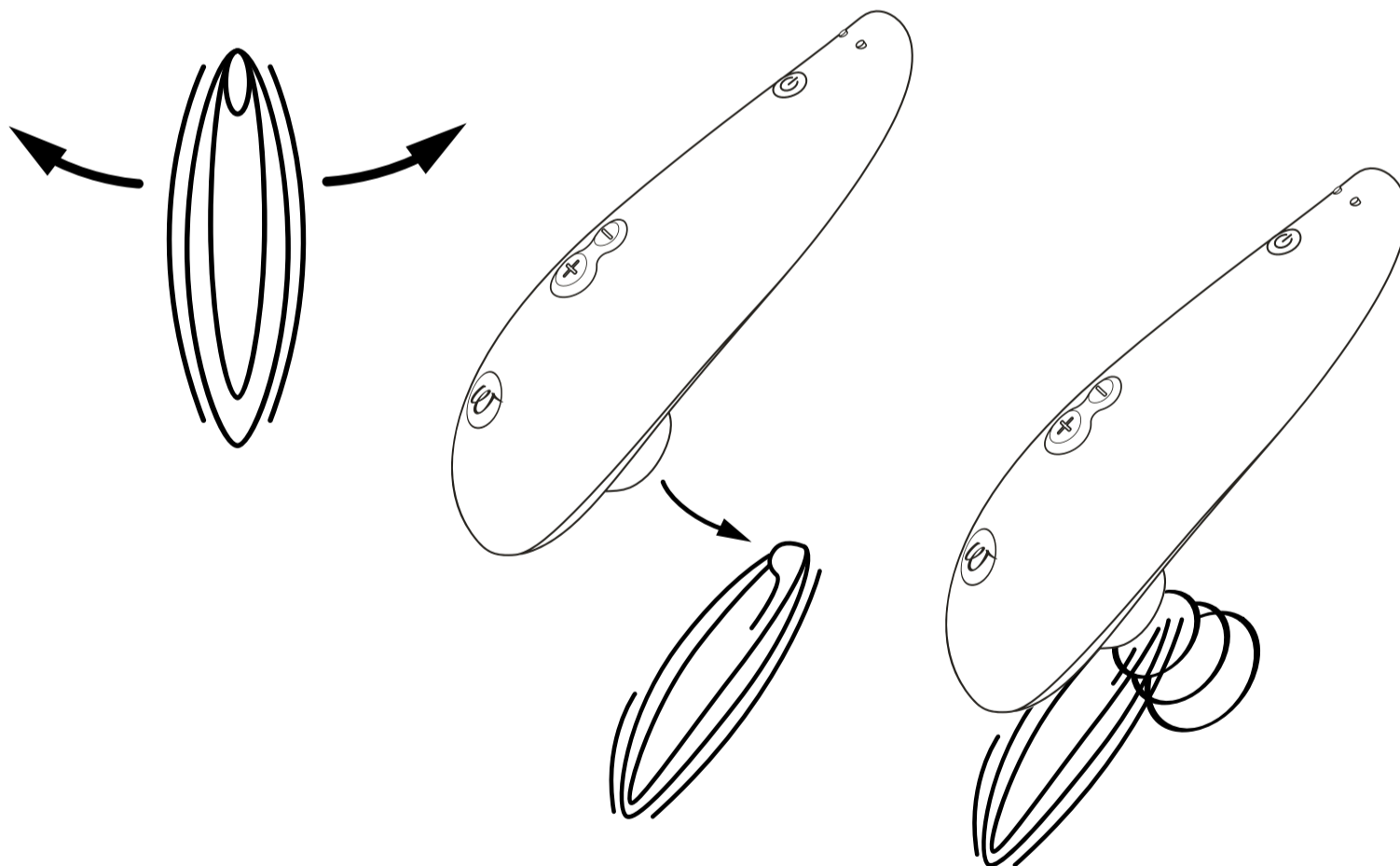

A SMALL TIP:

If you notice that the stimulation attachment doesn't yet have the optimal fit, switch between the two stimulation attachments (S and M) included with the device to create the best feeling for you.

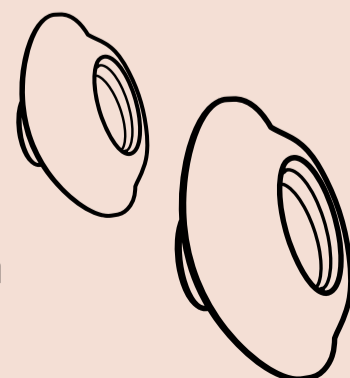

3. Change Intensity

Increase ●
press briefly

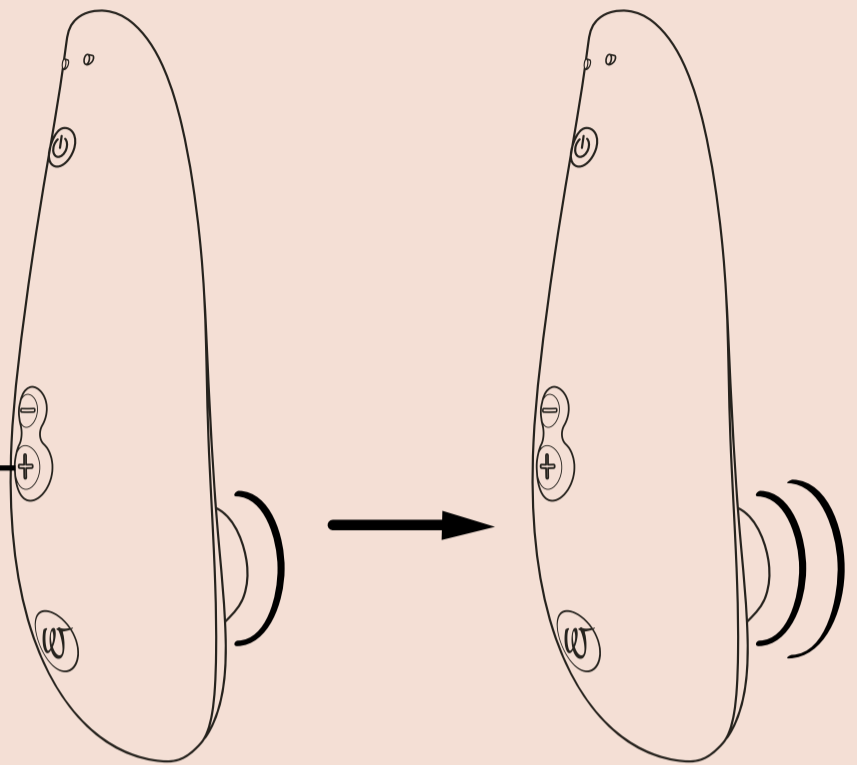

10  Intensity levels

Decrease ●
press briefly

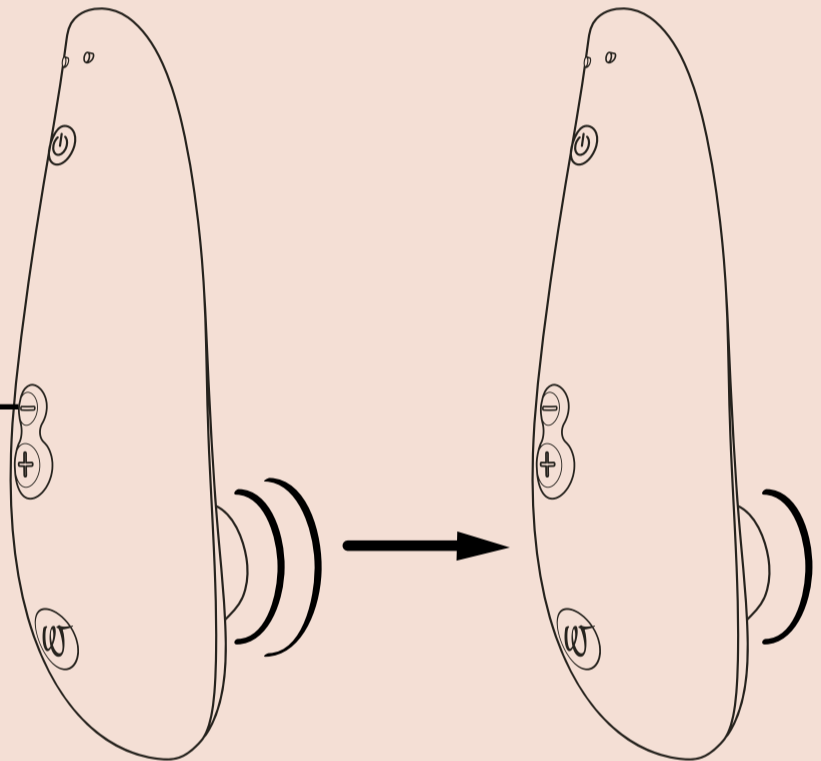

4. Afterglow Feature: Press power button briefly to fall back to intensity level 1.

5. Turn off

press for
2 seconds ●

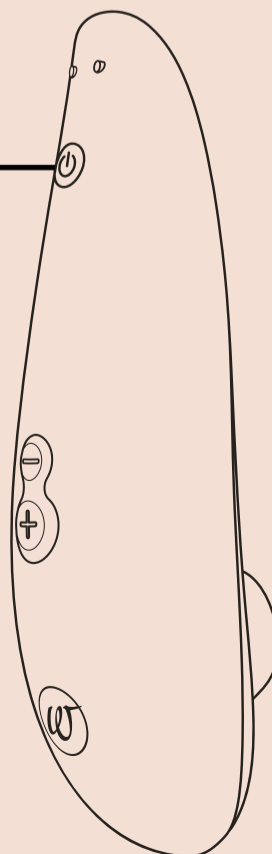

CHARGING

Please charge your Womanizer before first use. Also keep in mind to recharge your Womanizer regularly, to ensure a long battery life.

Charging

via USB port

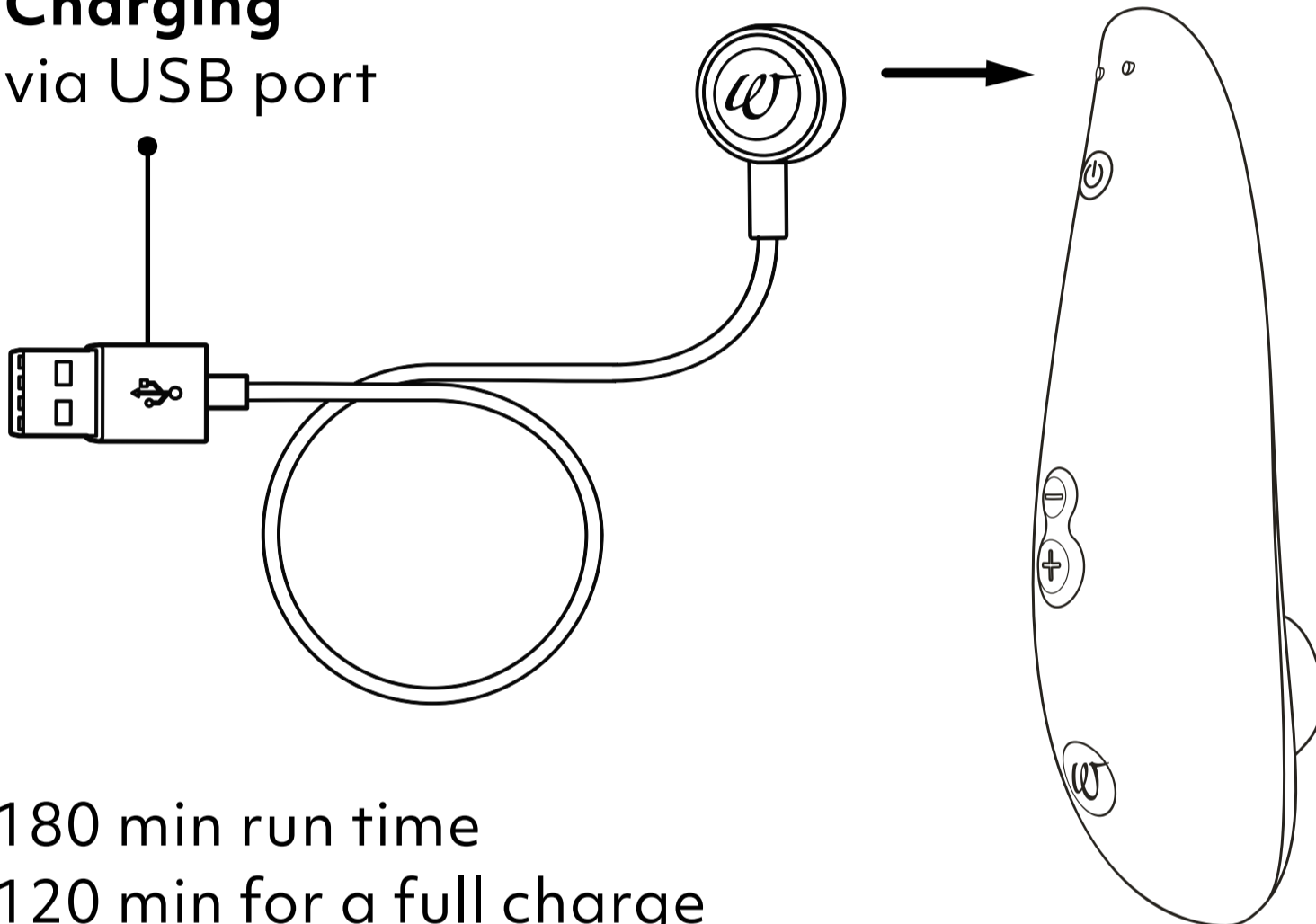

180 min run time
120 min for a full charge

LED Power Button

Battery Level

fully charged

led lights up continuously

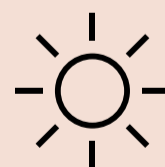

half charged

led flashes quickly

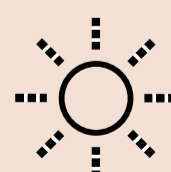

nearly discharged

led flashes slowly

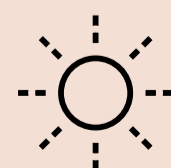

CLEANING

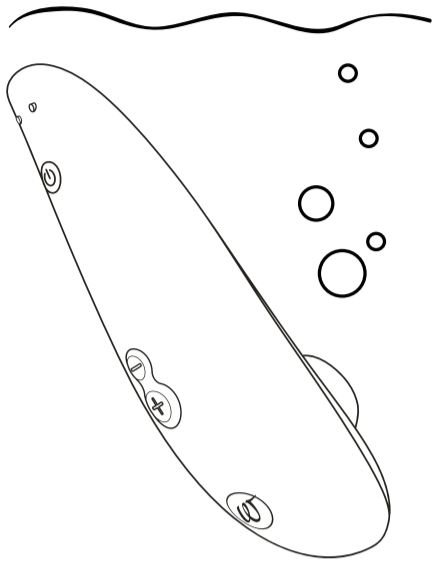

wash
under water

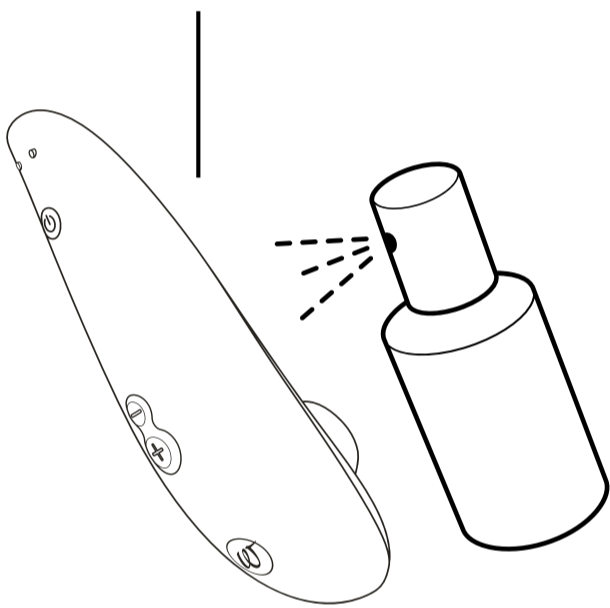

apply
toy cleaner

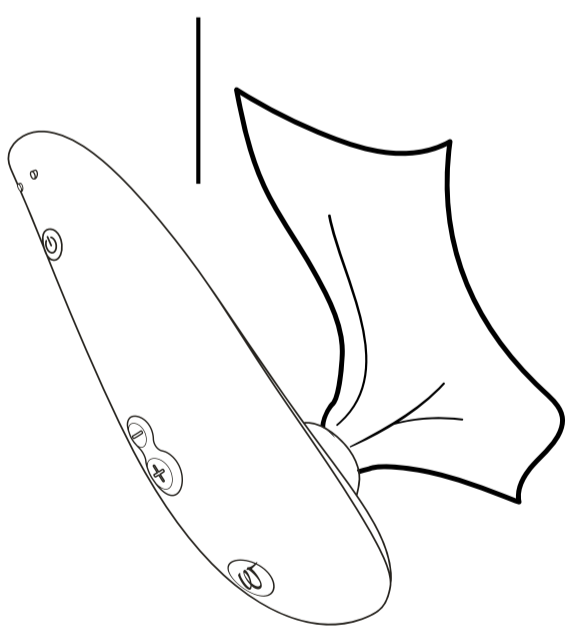

dry

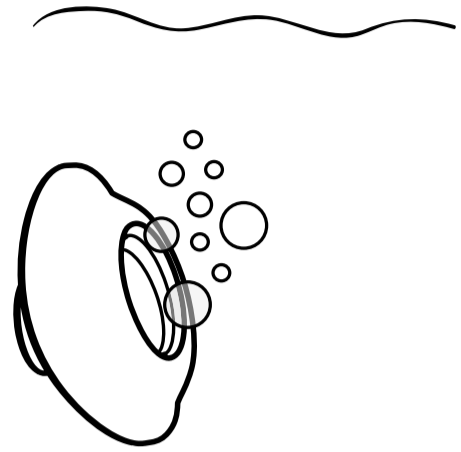

wash
under water

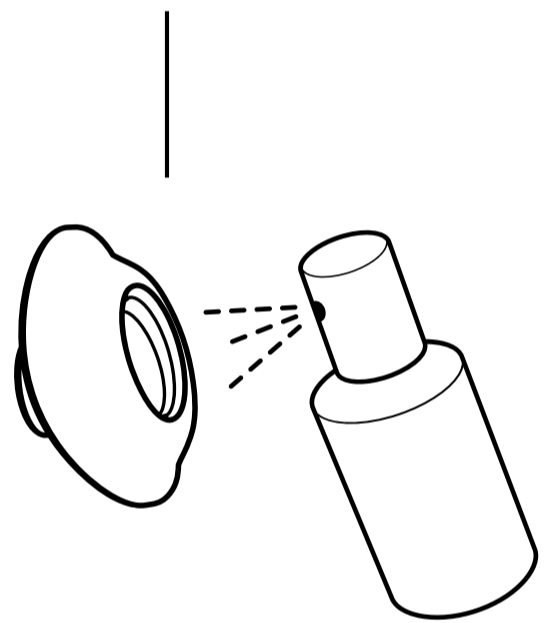

apply
toy cleaner

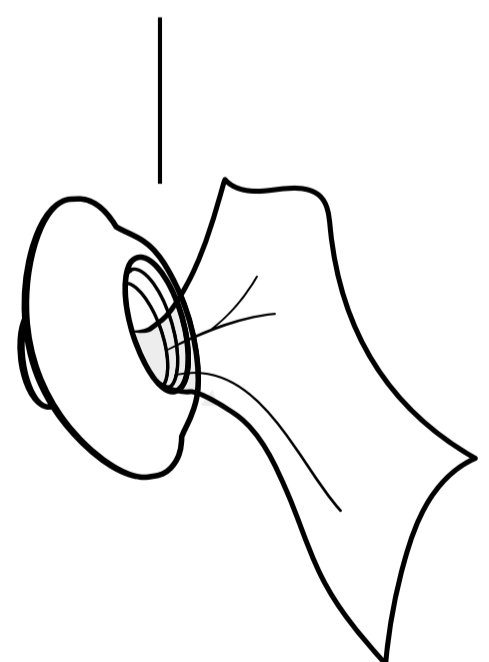

dry



Waterproof
IPX7

GENERAL INFORMATION

WARNING

Please read the safety instructions carefully for further information. Thoroughly clean your Womanizer before using it for the first time and after each usage to reduce the risk of infection.

CUSTOMER CARE

For further information please visit our website www.womanizer.com or contact care@womanizer.com.

TECHNICAL SPECIFICATIONS

Model: WZ08B

Power Rating: 100-240 V ~ 50/60 Hz

Output: 5 V = 0,75 A

Contains Li-ion rechargeable battery. AC/DC adaptor not included.

CONTENT OF DELIVERY

Womanizer Classic 2, USB charging cable, cotton storage pouch, 2 stimulation heads, quick start guide, safety instructions.

STORAGE

Store in a secure, dry place without exposure to direct sunlight.

WARRANTY

and voluntary manufacturer's warranty
WOW TECH EUROPE GMBH offers customers a voluntary manufacturer's warranty for this product in addition to the statutory warranty to which consumers are entitled with respect to sellers. The conditions with respect to the voluntary manufacturer's warranty are on our website, under „Warranty Conditions“.

FULFILLMENT OF STANDARDS

This appliance complies with all standards regarding electromagnetic compatibility (EMC). The device is safe to use as long as it is used correctly and in accordance with the instructions given in this user manual.

ENVIRONMENTAL PROTECTION

As a distributor of electronic devices, we are legally obliged to accept the return of waste electrical and electronic devices free of charge. We expressly state that you as the user are legally obliged to return used batteries. Never throw away electronic devices or batteries in the household waste. The symbol shown below, which is also attached to our electronic items, is intended to expressly remind you of this.

MANUFACTURER

WOW TECH EUROPE GMBH
Friedenstrasse 91 / 91 A
10249 Berlin, Germany

WOW TECH EUROPE GMBH

reserves the right to make technical changes and changes to the design that serve to improve the device.

Distributed in North America by
WOW TECH Canada Ltd.
330-1130 Morrison Drive
Ottawa, Ontario, Canada K2H 9N6

www.wowtech.com

Designed in Germany. Made in China
in 2021. Manual issued in 02/2021.
Version 1.

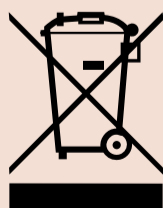

STILL WANT MORE?

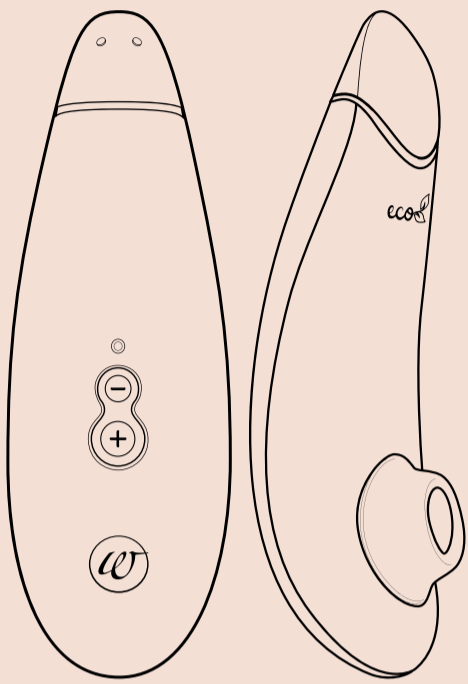

**Pleasure Air
Technology**



Smart Silence



Eco-friendly

Premium eco 

Loving Our Planet Can Be Orgasmic

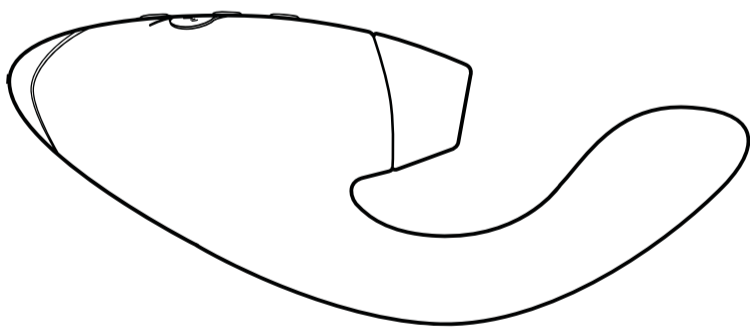

**Pleasure Air
Technology**



Vibrator



Smart Silence

DUO
Double your Pleasure



#IMASTURBATE

Bonjour !

**Nous vous remercions d'avoir choisi le
Womanizer !**

Bienvenue dans un univers rempli d'expériences sensuelles qui vont enrichir votre vie. En choisissant le WOMANIZER, vous allez non seulement ressentir des orgasmes incomparables, mais aussi un désir de plaisir entièrement nouveau.

Profitez de votre WOMANIZER - un orgasme l'un après l'autre.

Donnez-vous du plaisir !



DESCRIPTION PRODUIT

COMMENT L'UTILISER

LA CHARGE

L'ENTRETIEN

DESCRIPTION PRODUIT

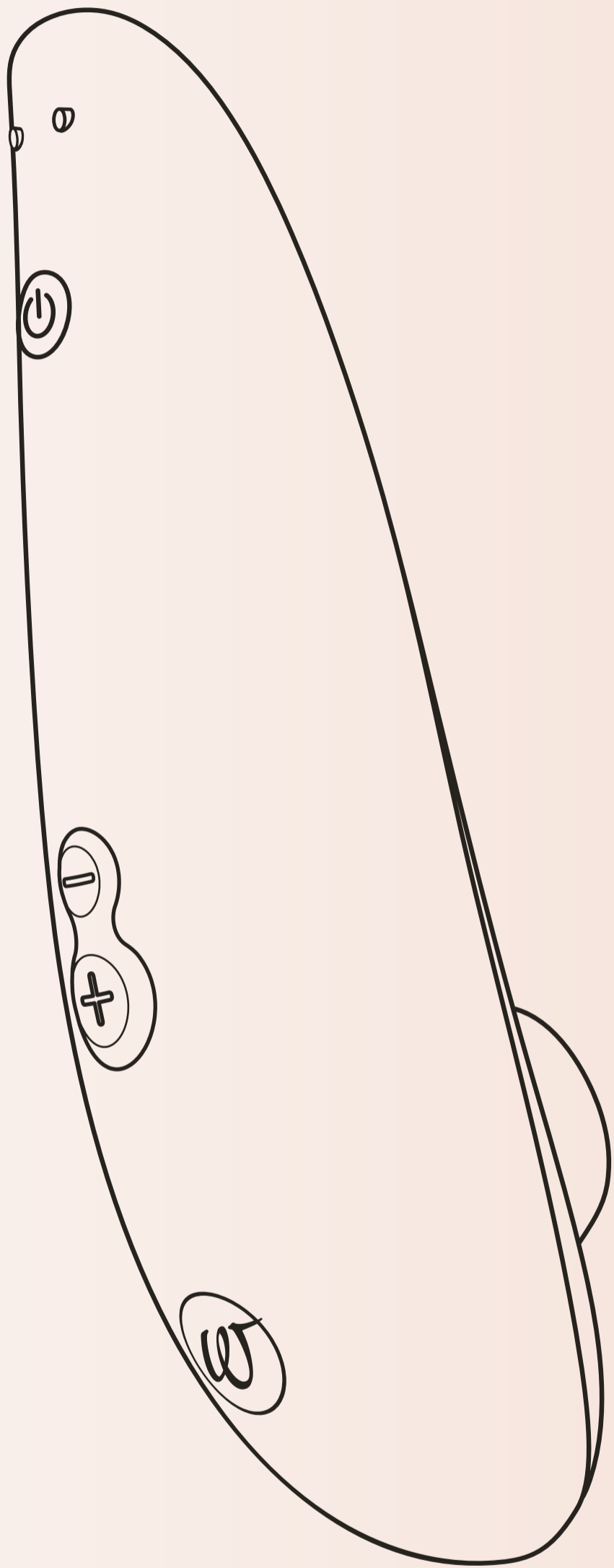

DESCRIPTION PRODUIT

Récepteurs pour la charge par induction

On/Off
Appuyez sur le bouton pendant 2 secondes

Fonction Afterglow
Appuyez brièvement sur le bouton

Diminuer l'intensité
Appuyez brièvement sur le bouton

Augmenter l'intensité
Appuyez brièvement sur le bouton

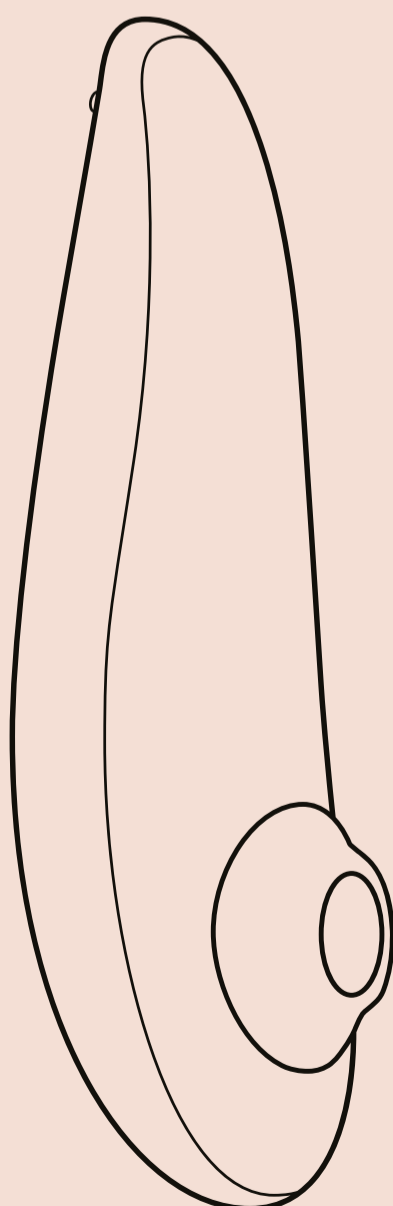
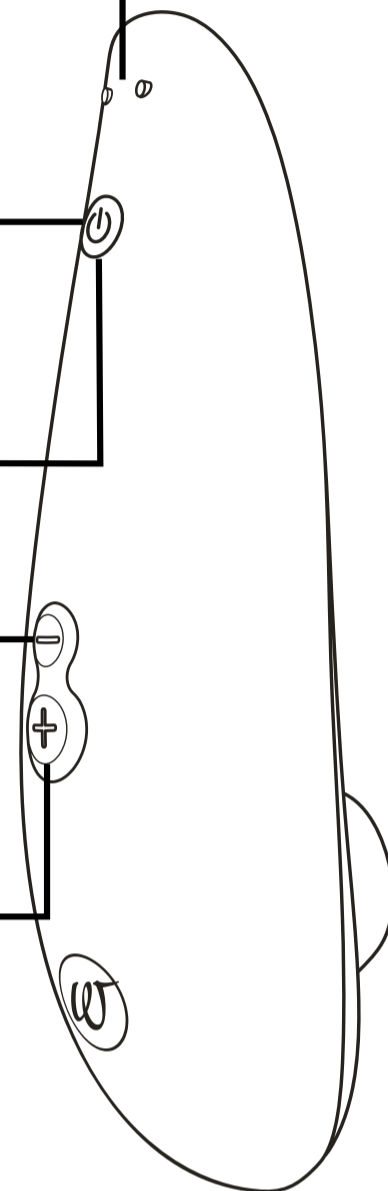

Embout de simulation

COMMENT L'UTILISER

1. Allumer

Appuyez pendant
2 secondes

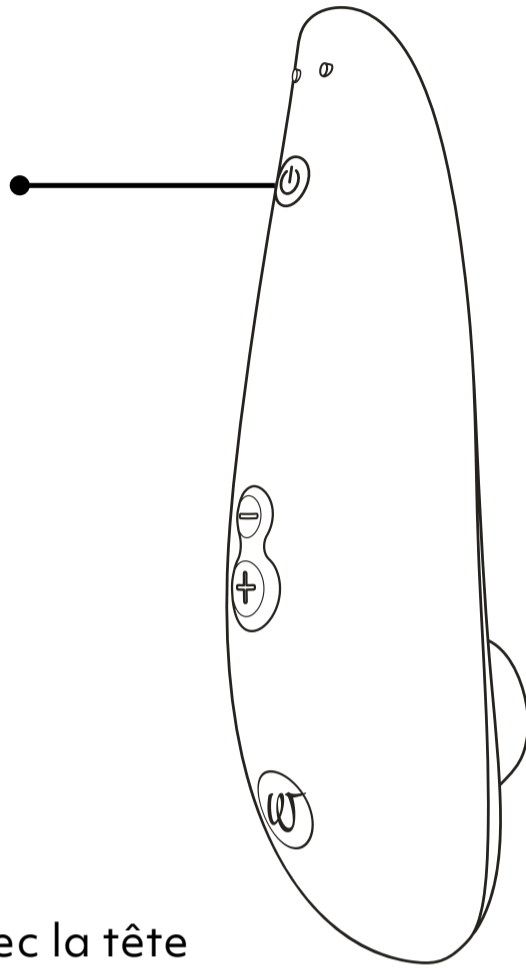

2. Utilisation

Enveloppez votre clitoris avec la tête de stimulation et débutez votre voyage.

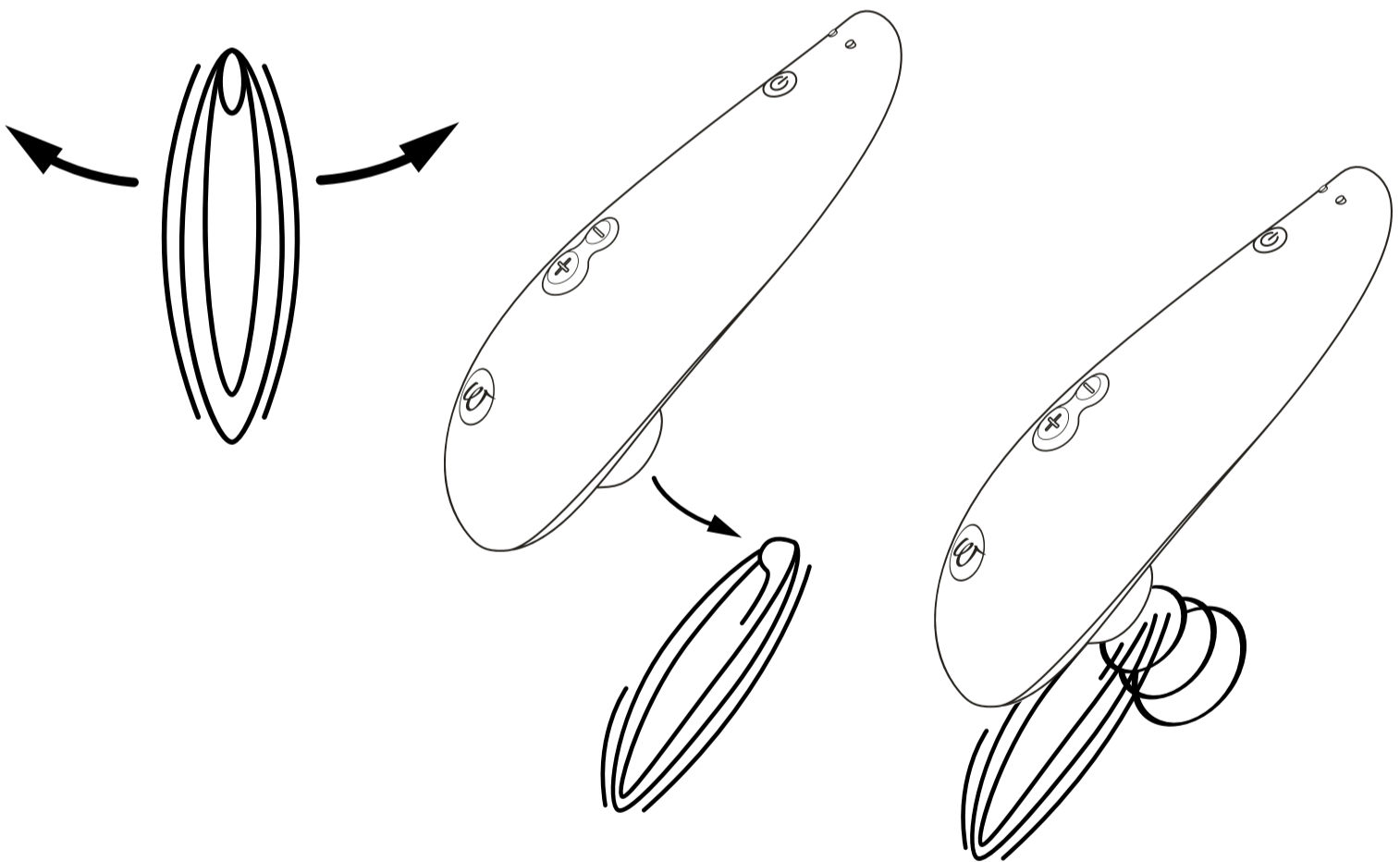

Un petit conseil :

Si vous remarquez que l'embout de stimulation n'est pas parfaitement adapté à votre anatomie, optez pour l'autre embout de stimulation (S ou M) inclus avec l'appareil pour vous permettre de ressentir des sensations optimales.

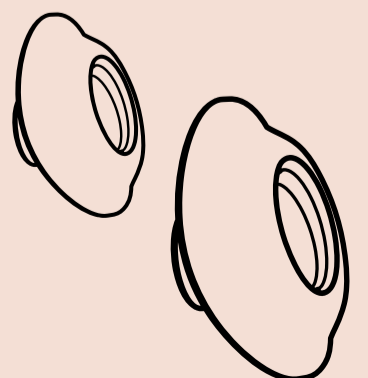

3. Régler l'intensité

Augmenter

Appuyez brièvement sur le bouton

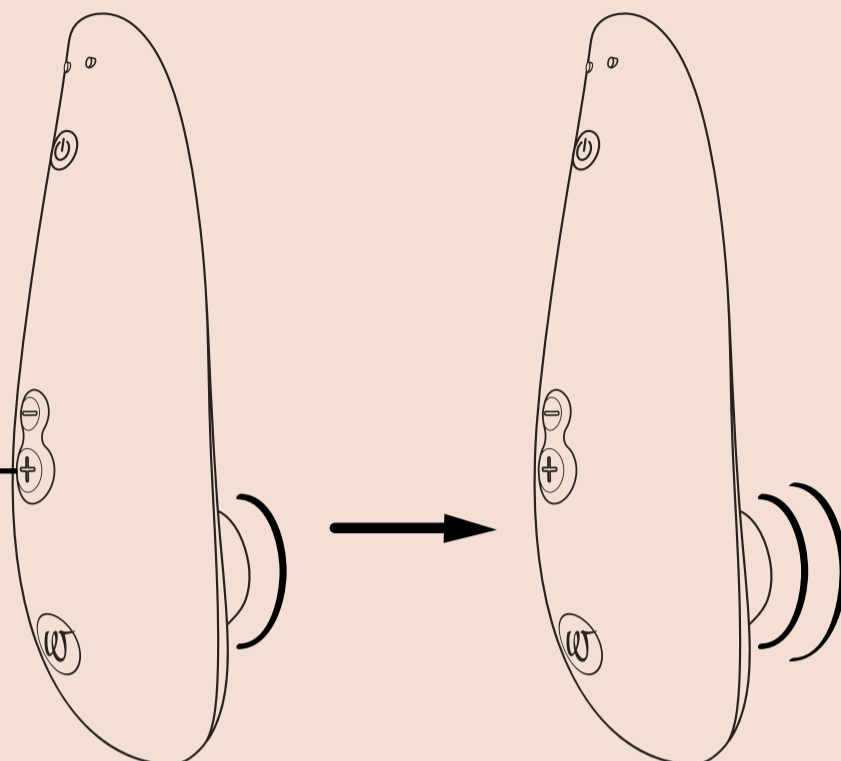

10  Niveaux d'intensité

Diminuer

Appuyez brièvement sur le bouton

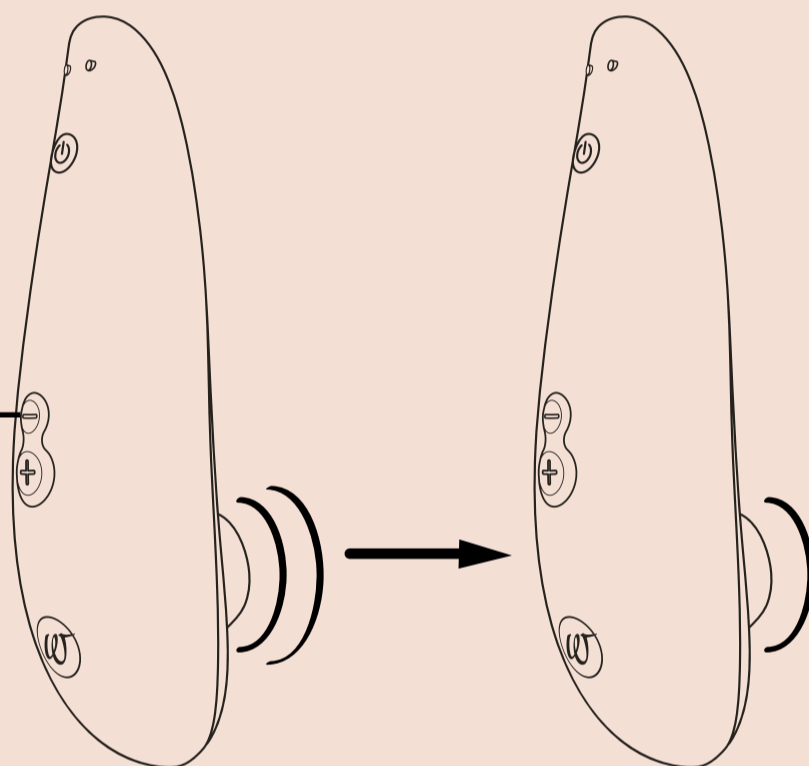

4. Fonction Afterglow : Appuyez brièvement sur le bouton pour retourner au niveau d'intensité 1.

4. Éteindre

Appuyez sur le bouton pendant **2 secondes**

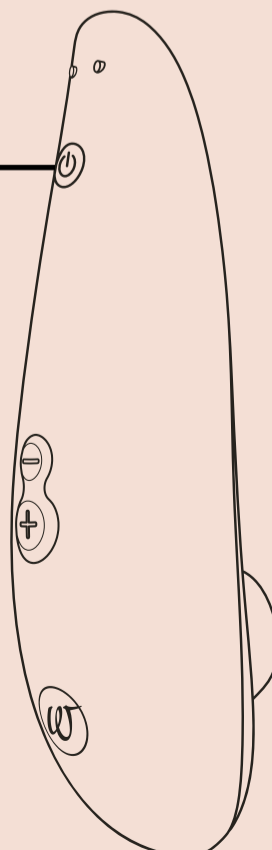

LA RECHARGE

Veillez charger votre Womanizer avant la première utilisation.
N'oubliez pas de recharger régulièrement votre Womanizer
afin de garantir une longue autonomie de la batterie.

La recharge
via le port USB

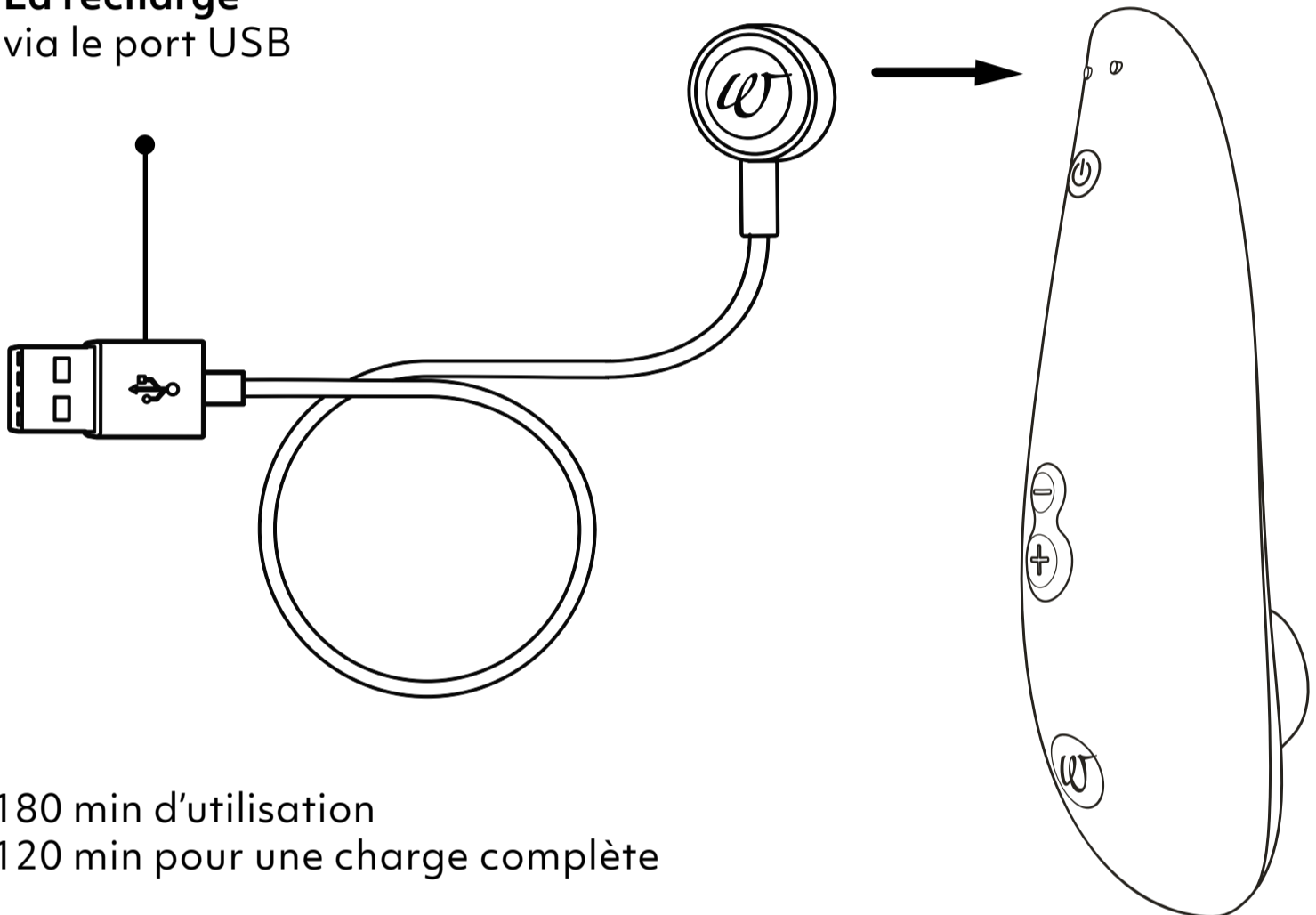

180 min d'utilisation
120 min pour une charge complète

Bouton Marche/Arrêt à LED

Niveau de la batterie

Entièrement rechargée

Les voyants LED sont allumés en permanence

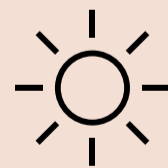

À moitié rechargée

Les voyants LED clignotent rapidement

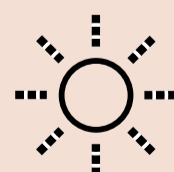

Presque vide

Les voyants LED clignotent lentement

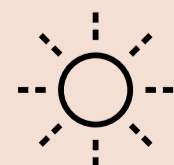

L'ENTRETIEN

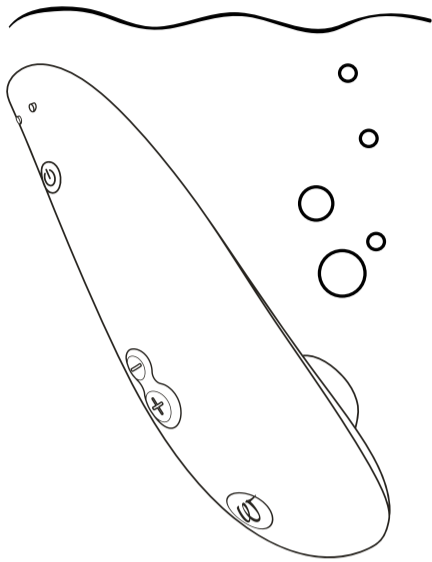

Lavez votre appareil
sous l'eau

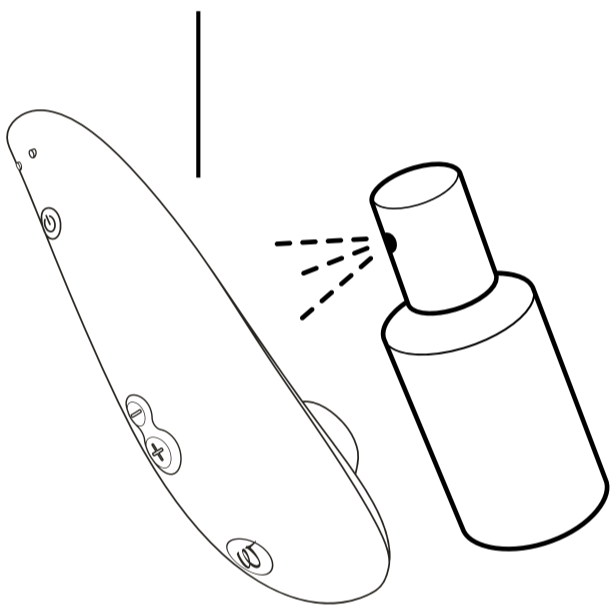

Utilisez un nettoyant
pour sextoys

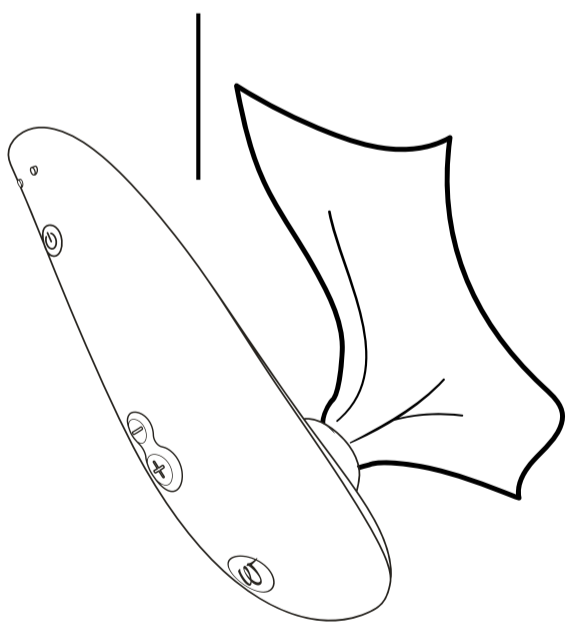

Séchage

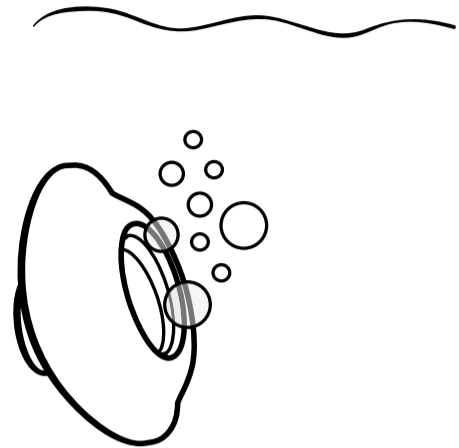

Lavez votre appareil
sous l'eau

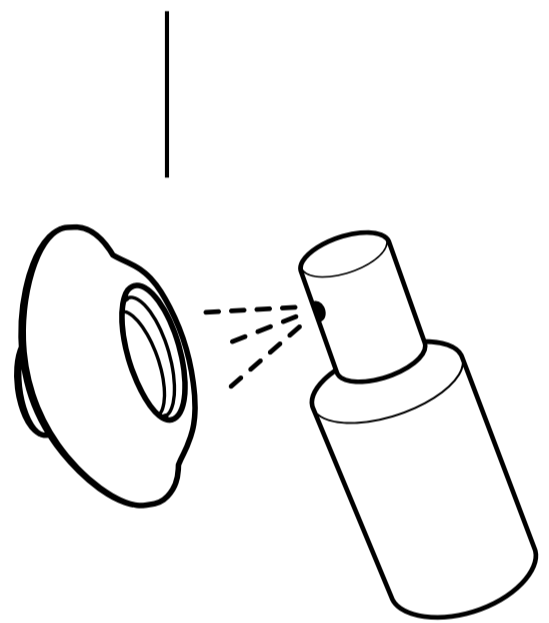

Utilisez un nettoyant
pour sextoys

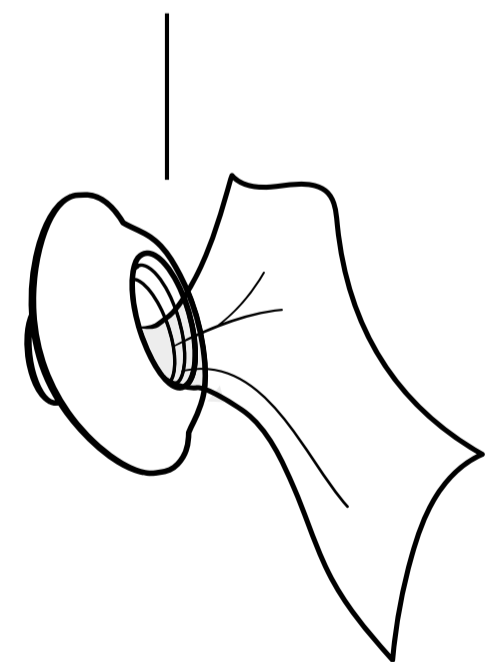

Séchage



Waterproof
IPX7

INFORMATIONS GÉNÉRALES

INFORMATIONS GÉNÉRALES AVERTISSEMENT

Veillez lire soigneusement les consignes de sécurité pour de plus amples informations.

Nettoyez soigneusement votre Womanizer avant de l'utiliser pour la première fois et après chaque nouvel usage afin de minimiser le risque d'infection.

SERVICE CLIENTÈLE

Pour de plus amples informations, rendez-vous sur notre site web www.womanizer.com ou contactez care@womanizer.com.

CARACTÉRISTIQUES TECHNIQUES

Modèle : WZ08B

Puissance nominale : 100-240 V ~
50/60 Hz

Sortie : 5 V $\overline{=}$ 0.75 A

Contient une batterie li-ion rechargeable.

Adaptateur AC/DC non inclus.

CONTENU DE L'EMBALLAGE

Womanizer Classic 2, câble de charge USB, pochette de rangement en coton, 2 embouts de stimulation, un guide de démarrage rapide, consignes de sécurité.

RANGEMENT

À conserver dans un endroit sûr et sec sans exposition directe aux rayons du soleil.

GARANTIE ET GARANTIE DU FABRICANT

WOW TECH EUROPE GMBH offre à ses clients une garantie fabricant pour ce produit en supplément de la garantie obligatoire accordée aux consommateurs.

Vous pouvez consulter les conditions relatives à notre garantie fabricant sur notre site Internet dans la rubrique « Conditions de garantie ».

RESPECT DES NORMES

Cet appareil répond à toutes les normes relatives à la compatibilité électromagnétique (CEM). Cet appareil ne présente aucun danger dans la mesure

où il est utilisé correctement dans le respect des instructions fournies dans le manuel d'utilisateur.

PROTECTION ENVIRONNEMENTALE

En tant que distributeur d'appareils électroniques, nous sommes légalement tenus par la loi d'accepter gratuitement le retour des déchets des équipements électriques et électroniques. Nous vous informons explicitement qu'en tant qu'utilisateur, vous êtes légalement tenu de retourner les batteries utilisées. Ne jetez jamais des appareils électroniques ou des batteries avec les déchets ménagers. Le symbole présenté ci-dessous et également présent sur nos appareils électroniques sert à vous rappeler expressément cette obligation.

FABRICANT

WOW Tech Europe GmbH,
Friedenstrasse 91 / 91 a, 10249 Berlin, Allemagne

WOW Tech Europe GmbH se réserve le droit de procéder à des modifications techniques ou de la conception de ce produit afin de l'optimiser.

Distribué en Amérique du Nord par WOW TECH Canada Ltd. 1545 Carling Avenue, Suite 401, Ottawa ON, Canada K1Z 8P9

www.wowtech.com Conçu en Allemagne. Produit en Chine en 2021. Manuel publié en 02/2021. Version 1.



ENVIE DE PLUS ?

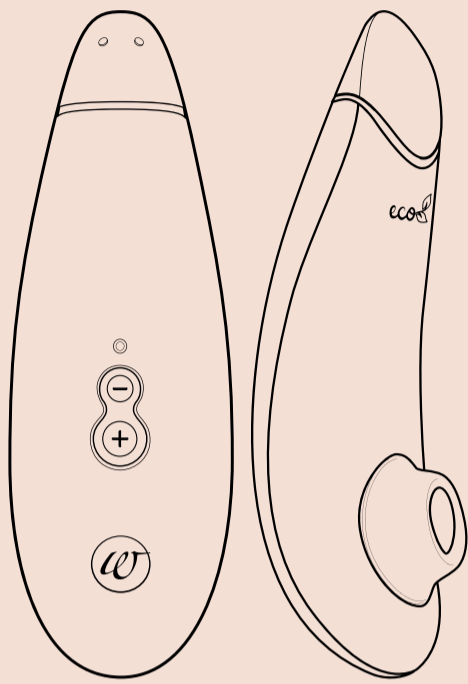

**Pleasure Air
Technology**



Smart Silence



Eco-friendly

Premium eco 

Loving Our Planet Can Be Orgasmic

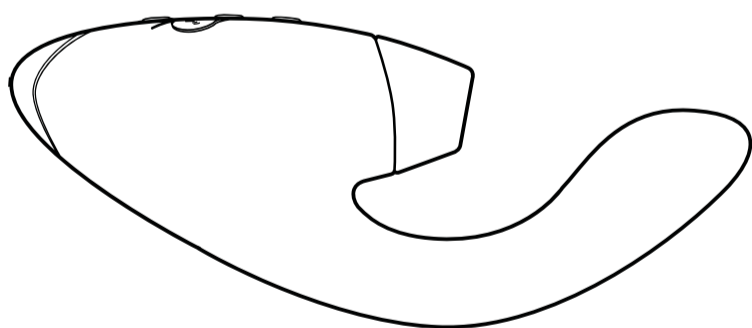

**Pleasure Air
Technology**



Vibrator



Smart Silence

DUO

Double your Pleasure



#IMASTURBATE

Hi!

Schön, dass Du Dich für den Womanizer entschieden hast!

Wir heißen Dich willkommen in einer Welt voll sinnlicher Erlebnisse, die Dein Leben bereichern werden. Mit der Entscheidung für den WOMANIZER sind Dir nicht nur unvergleichliche Orgasmen sicher – sondern auch ein vollkommen neues Lustgefühl.

Hab viel Freude mit Deinem WOMANIZER – und einen Orgasmus nach dem anderen.

Liebe Dich selbst!



PRODUKTBESCHREIBUNG

BENUTZUNG

LADEN

REINIGUNG

ALLGEMEINE INFORMATIONEN

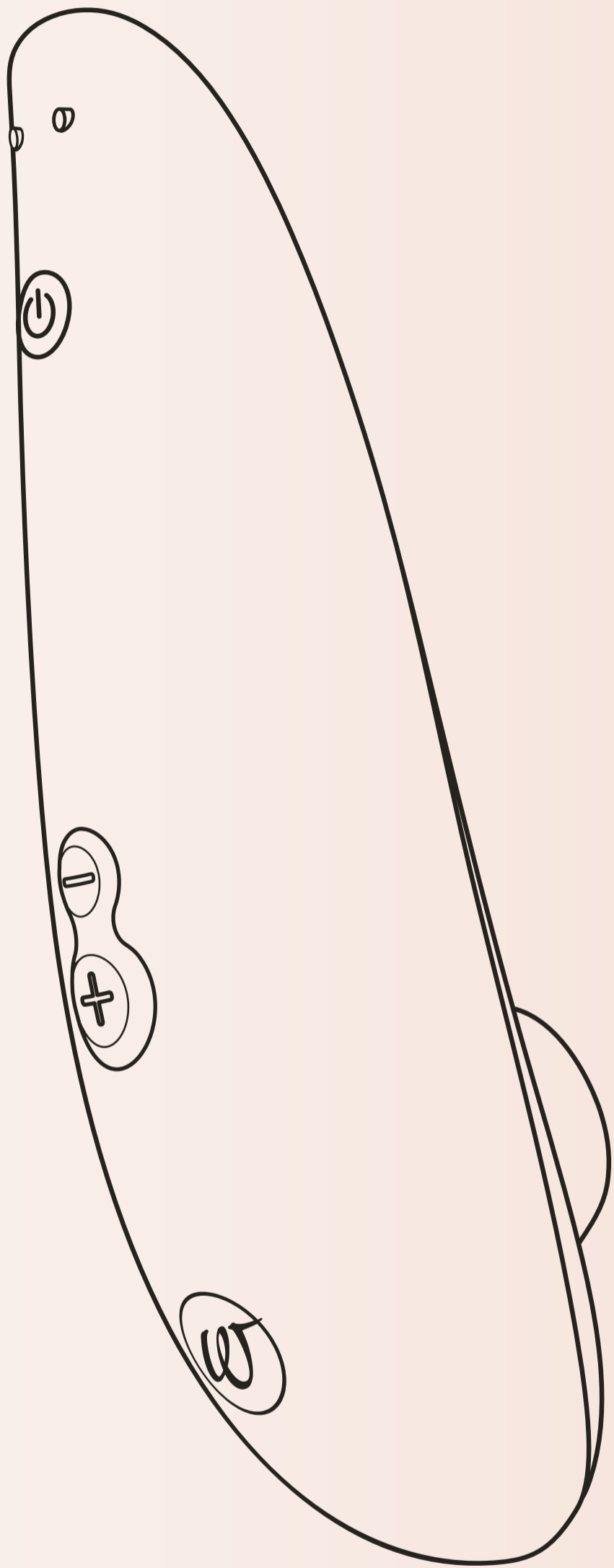

PRODUKTBESCHREIBUNG

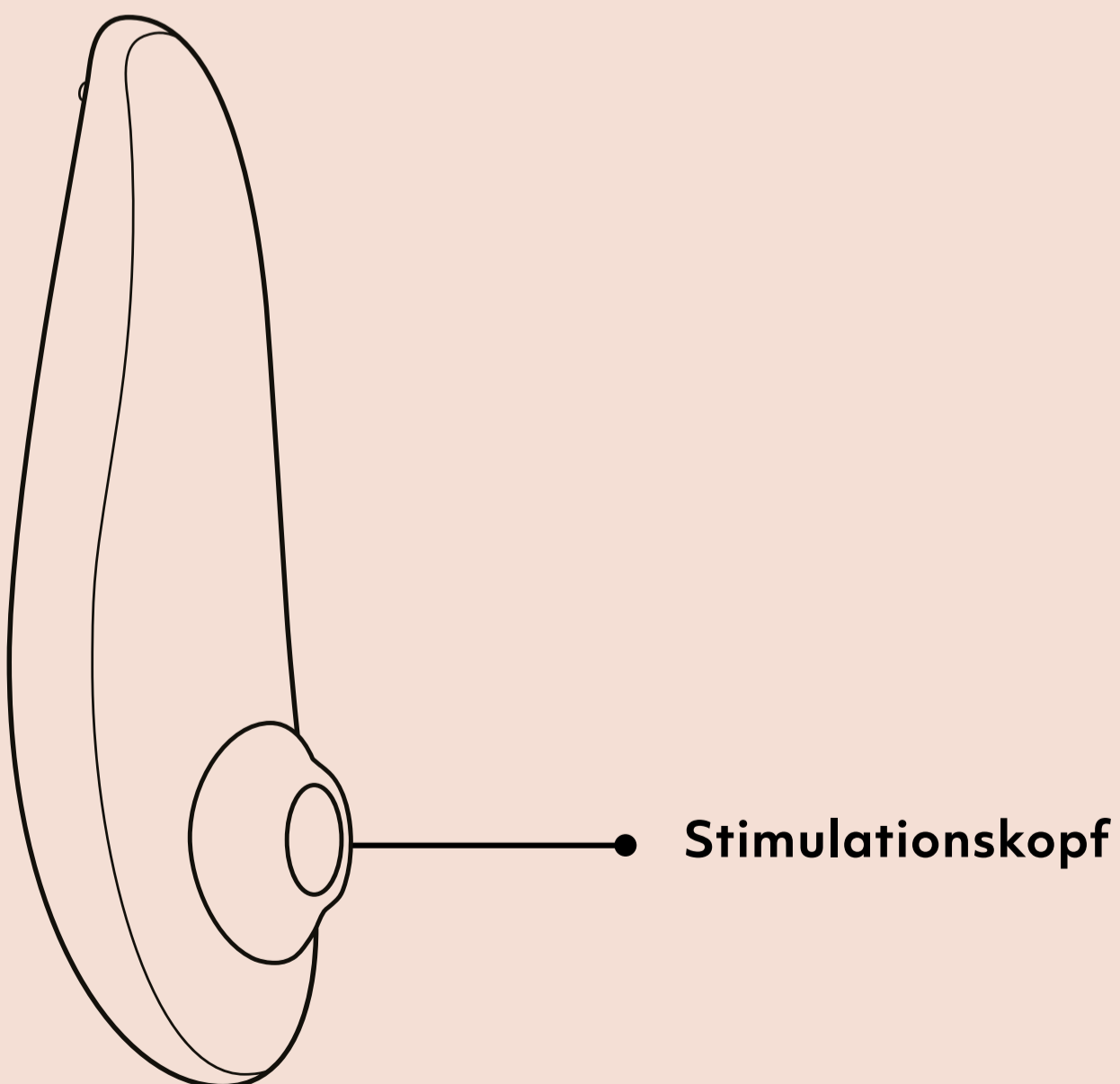
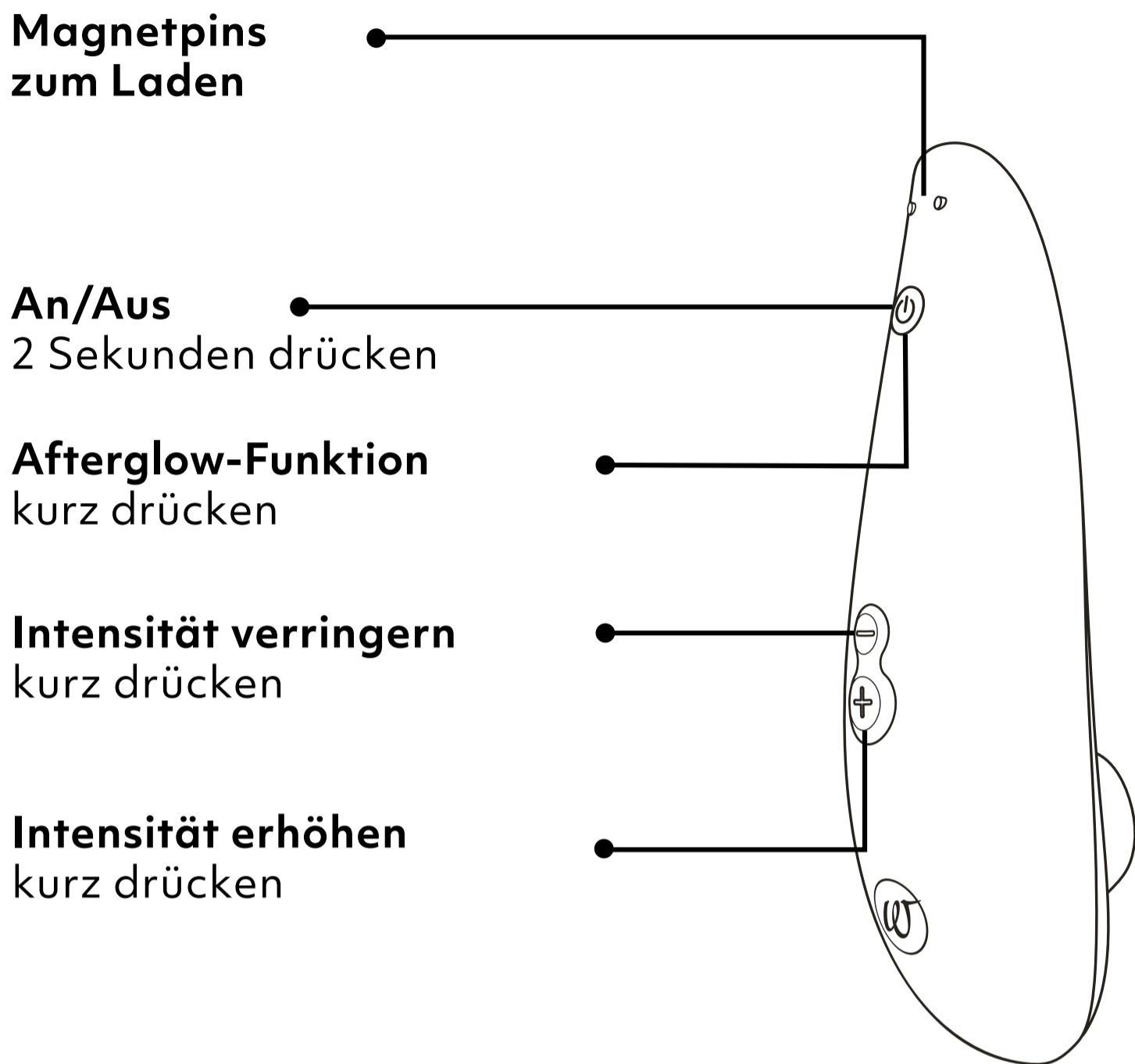

BENUTZUNG

1. Einschalten

2 Sekunden
drücken

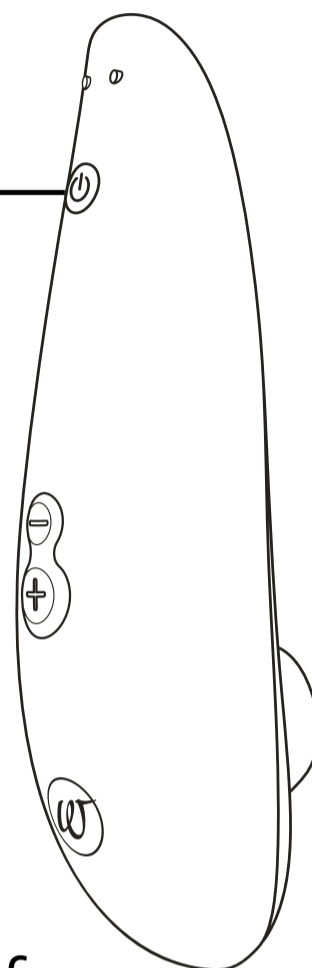

2. Benutzung

Lege den Stimulationskopf
auf die Klitoris und lass Dich
verwöhnen.

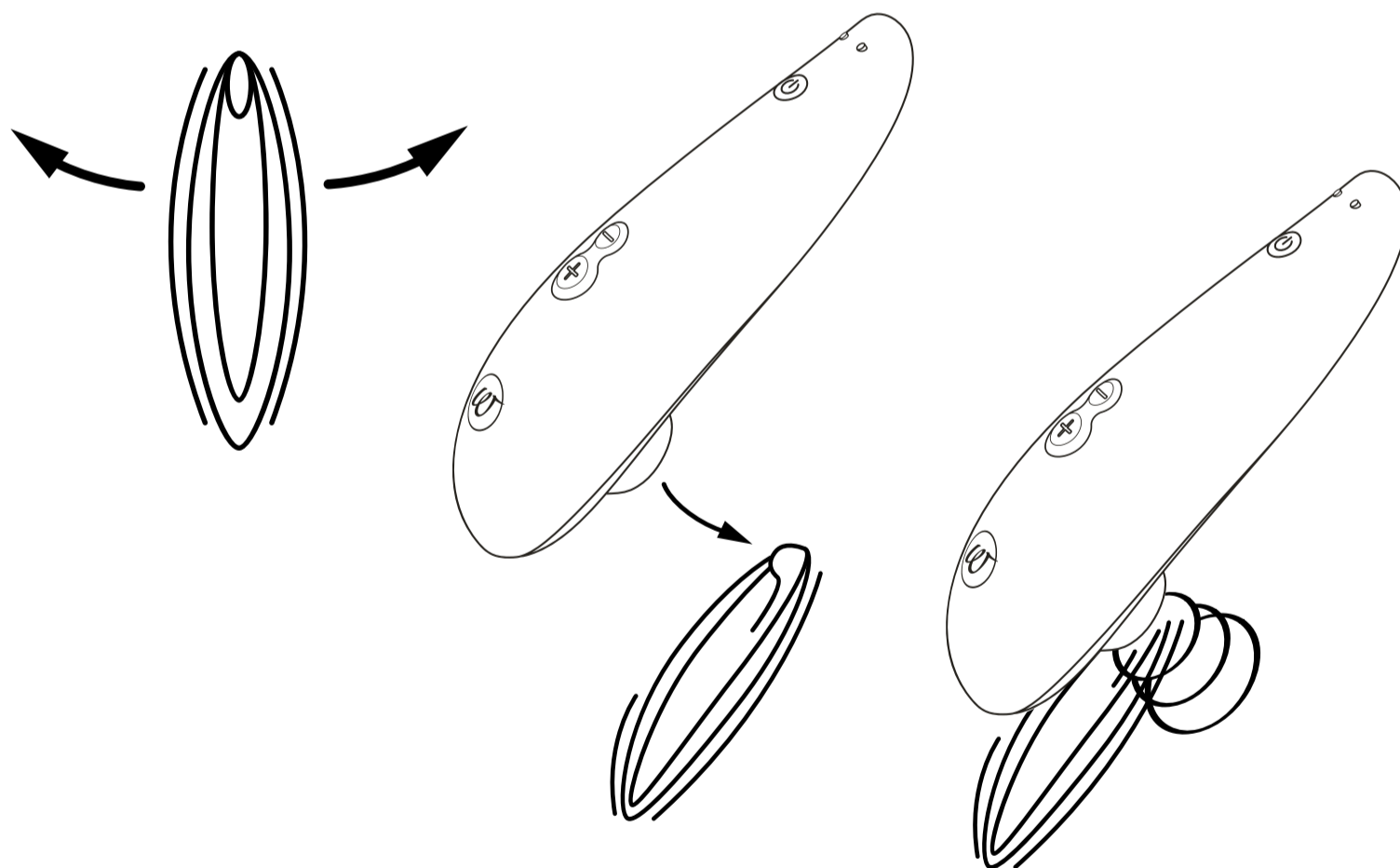

Ein kleiner Tipp:

Solltest Du bemerken, dass die Passform des Stimulationsaufsatzes noch nicht optimal ist, so wechsele zwischen beiden im Lieferumfang enthaltenen Stimulationsaufsätzen (S und M), um das für Dich optimale Gefühl zu erzeugen.

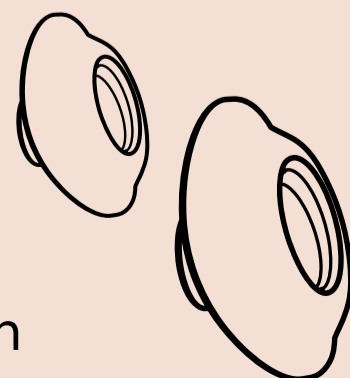

3. Intensität ändern

Erhöhen

kurz drücken

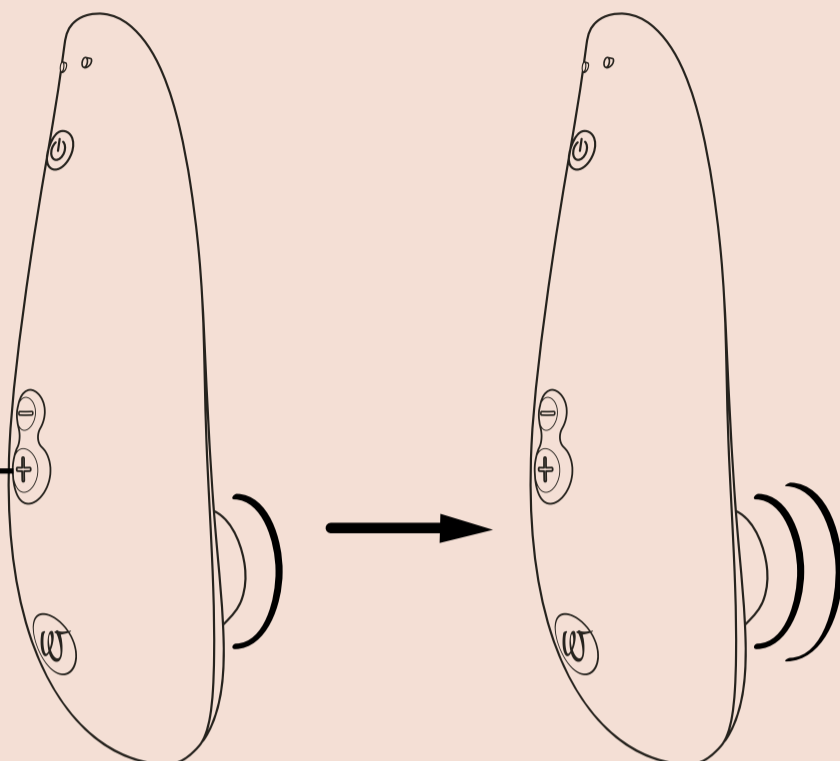

10  Intensity levels

Verringern

kurz drücken

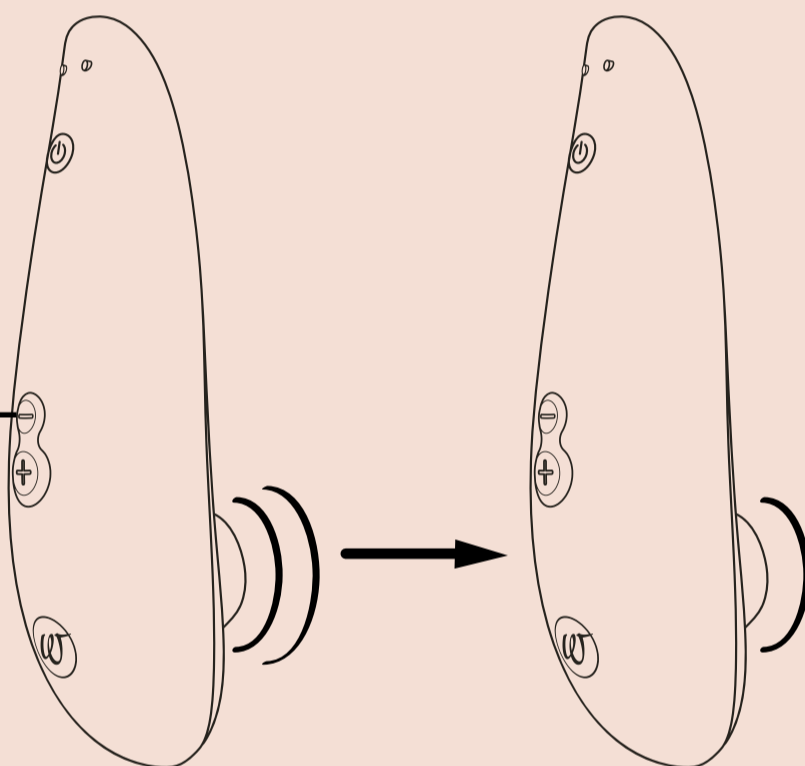

4. Afterglow-Funktion: Drücke kurz den Netzschalter, um auf Intensitätsstufe 1 zurückzuschalten.

4. Ausschalten

2 Sekunden
drücken

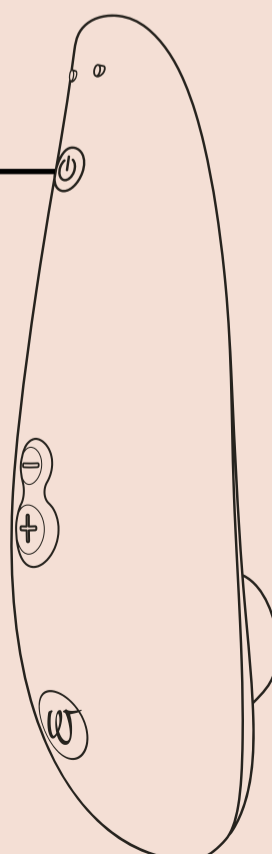

LADEN

Bitte lade Deinen Womanizer vor dem ersten Benutzen auf. Achte außerdem darauf, Deinen Womanizer regelmäßig aufzuladen, um eine lange Akkulaufzeit zu gewährleisten.

Laden über USB-Anschluss

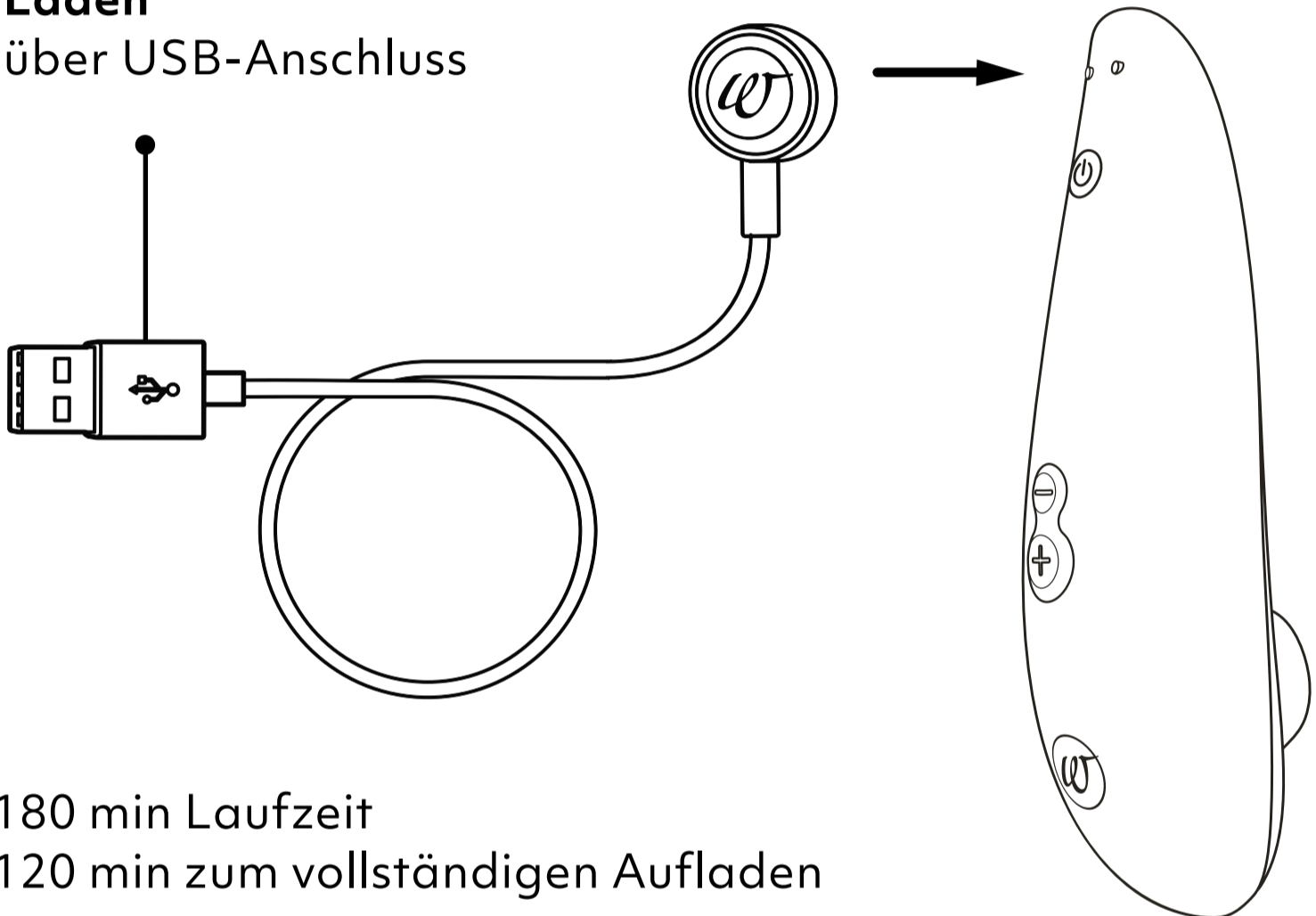

180 min Laufzeit
120 min zum vollständigen Aufladen

LED-Netzschalter

Batteriestand

Vollständig geladen

Die LED leuchtet kontinuierlich.

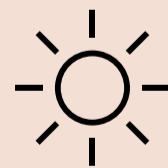

Halb geladen

Die LED blinkt schnell.

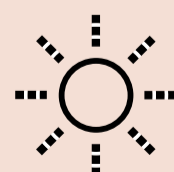

Fast entladen

Die LED blinkt langsam.

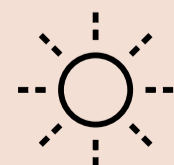

REINIGUNG

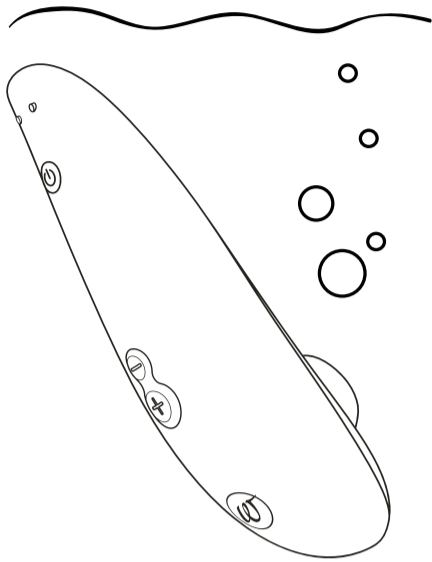

unter Wasser
waschen

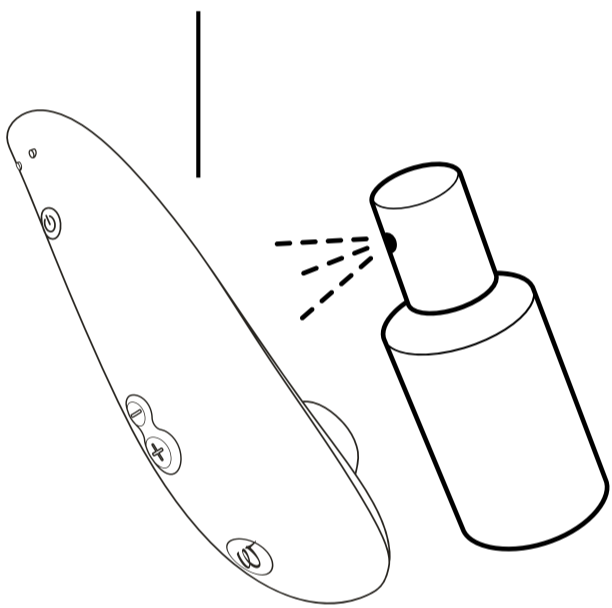

Sextoy-Reiniger
auftragen.

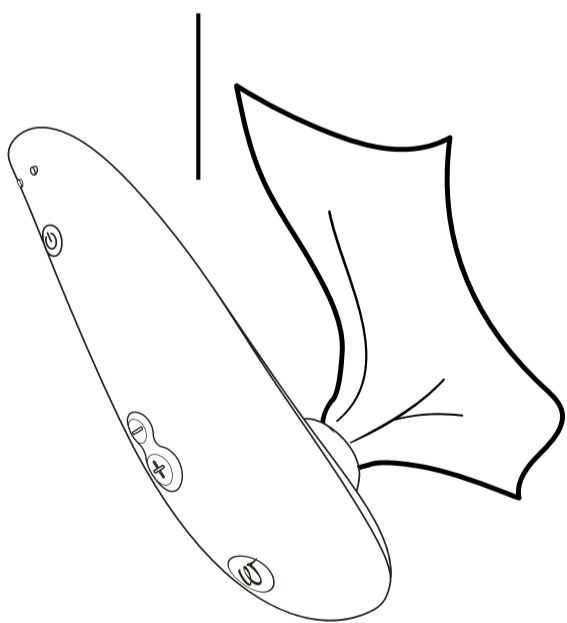

Abtrocknen

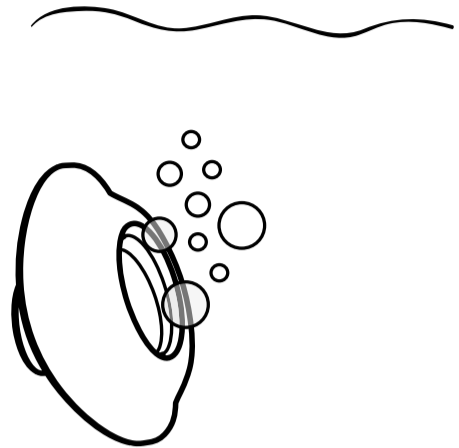

unter Wasser
waschen

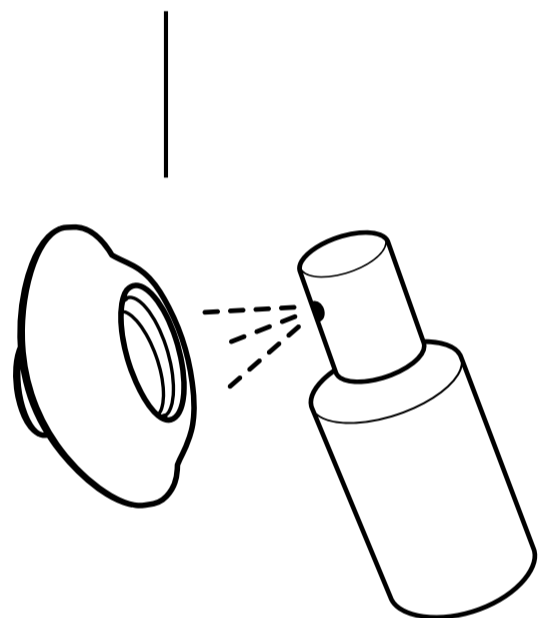

Sextoy-Reiniger
auftragen.

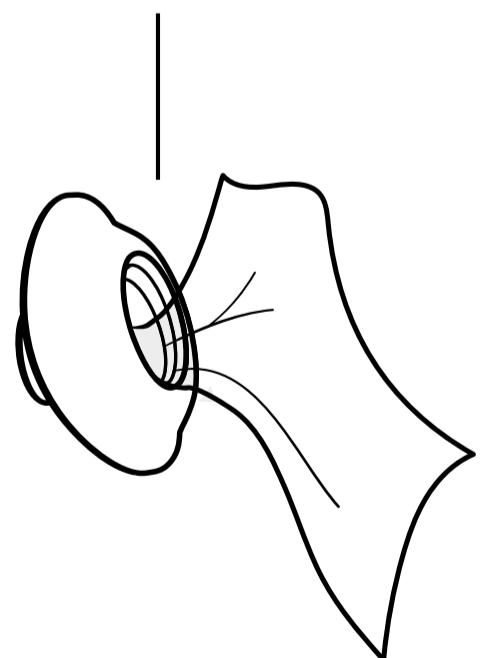

Abtrocknen



Waterproof
IPX7

ALLGEMEINE INFORMATIONEN

WARNHINWEIS

Lies bitte sorgfältig die Sicherheitshinweise, die weitere Informationen enthalten. Reinige Deinen Womanizer vor dem ersten Gebrauch sowie nach jedem Gebrauch gründlich, um das Infektionsrisiko zu verringern.

KUNDENSERVICE

Weitere Informationen findest Du auf unserer Website www.womanizer.com, oder Du wendest Dich an care@womanizer.com.

TECHNISCHE DATEN

Modell: WZ08B

Nennleistung: 100–240 V ~ 50/60 Hz

Leistungsabgabe: 5 V \approx 0.75 A

Enthält einen Lithium-Ionen-Akku.

Netzadapter nicht im Lieferumfang enthalten.

LIEFERUMFANG

Womanizer Classic 2, USB-Ladekabel, Aufbewahrungstäschchen aus Baumwolle, zwei Stimulationsaufsätze, Kurzanleitung, Sicherheitshinweise.

AUFBEWAHRUNG

An einem sicheren, trockenen Ort ohne direkte Sonneneinstrahlung aufbewahren.

GEWÄHRLEISTUNG UND FREIWILLIGE HERSTELLERGARANTIE

Die WOW TECH EUROPE GMBH bietet ihren Kunden für dieses Produkt zusätzlich zur gesetzlichen Gewährleistung, die dem Verbraucher gegenüber seinem Verkäufer zusteht, eine freiwillige Herstellergarantie.

Die Bedingungen der freiwilligen Herstellergarantie findest Du auf unserer Website im Abschnitt „Garantiebedingungen“.

ERFÜLLUNG VON NORMEN

Dieses Gerät entspricht allen Normen zur elektromagnetischen Verträglichkeit (EMV). Die Anwendung dieses Produkts ist sicher, sofern es ordnungsgemäß und entsprechend den Anweisungen in dieser Bedienungsanleitung verwendet wird.

UMWELTSCHUTZ

Als Vertreiber von Elektronikgeräten sind wir gesetzlich verpflichtet, Elektrogeräte und Elektronikaltgeräte unentgeltlich zurückzunehmen. Wir machen Dich zudem darauf aufmerksam, dass Du als Verbraucher gesetzlich dazu verpflichtet bist, gebrauchte Batterien zurückzugeben. Wirf Elektrogeräte und Batterien niemals in den Hausmüll.

Das nachfolgende Symbol, das auch auf unseren Elektronikartikeln angebracht ist, soll Dich hierauf noch einmal ausdrücklich hinweisen.

HERSTELLER

WOW Tech Europe GmbH,
Friedenstraße 91 / 91 a, 10249 Berlin, Deutschland

WOW Tech Europe GmbH behält sich das Recht vor, technische und gestalterische Änderungen vorzunehmen, die der Verbesserung des Geräts dienen.

Vertrieb in Nordamerika durch WOW TECH Canada Ltd. 1545 Carling Avenue, Suite 401, Ottawa ON, Kanada K1Z 8P9

www.wowtech.com Designed in Deutschland. Hergestellt in China 2021. Bedienungsanleitung Ausgabe 02.2021. Version 1.

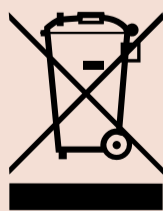

DU MÖCHTEST NOCH MEHR?

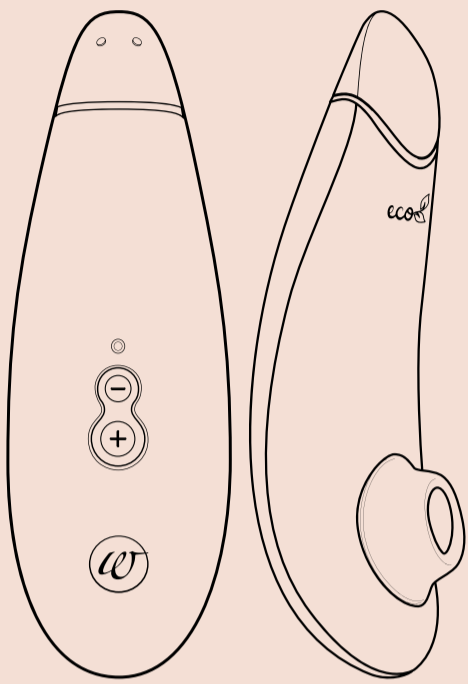

**Pleasure Air
Technology**



Smart Silence



Eco-friendly

Premium eco 

Loving Our Planet Can Be Orgasmic

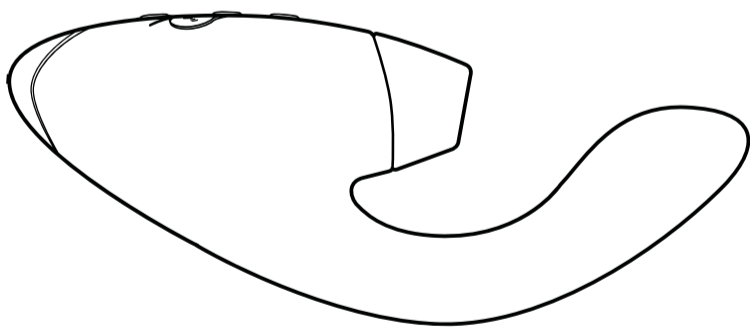

**Pleasure Air
Technology**



Vibrator



Smart Silence

DUO
Double your Pleasure



#IMASTURBATE

¡Hola!

Gracias por elegir Womanizer!

Te damos la bienvenida a un mundo de sensualidad que llenará tu vida de placer. Al elegir WOMANIZER, no solo te aseguras orgasmos incomparables, sino también un deseo de placer completamente nuevo.

Disfruta de tu WOMANIZER, un orgasmo después de otro.

¡Vamos! ¡Quiérete!



DESCRIPCIÓN DEL PRODUCTO

INDICACIONES DE USO

CARGA

LIMPIEZA

INFORMACIÓN GENERAL

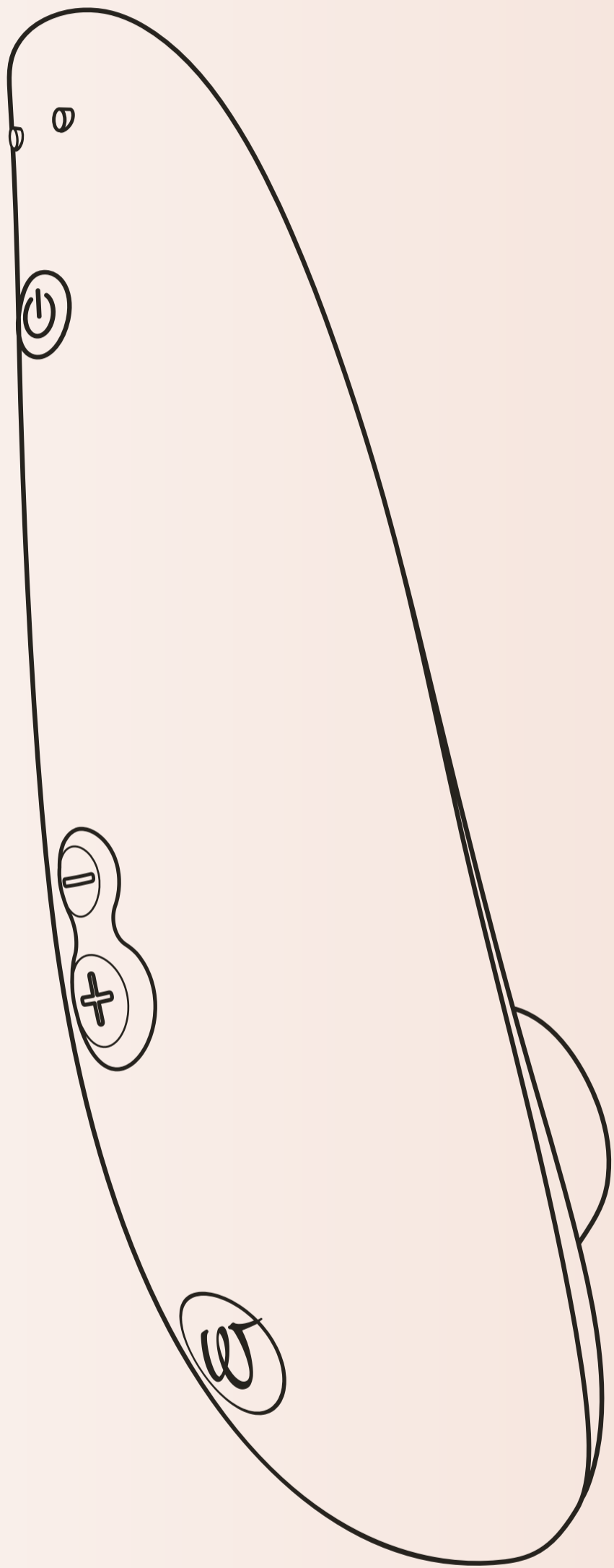

DESCRIPCIÓN DEL PRODUCTO

Pines de carga magnéticos

On/Off
pulsa durante 2 segundos

Función Afterglow
pulsa brevemente

Disminución de la intensidad
pulsa brevemente

Aumento de la intensidad
pulsa brevemente

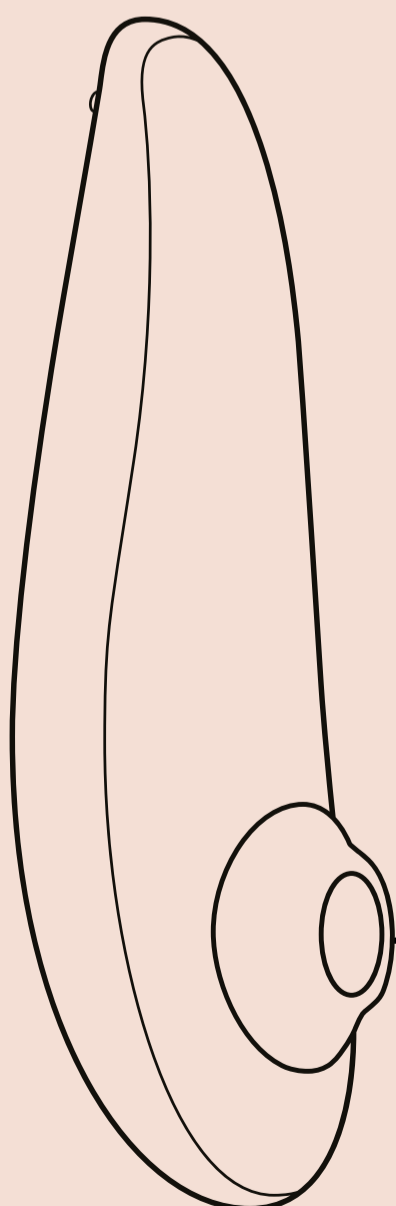
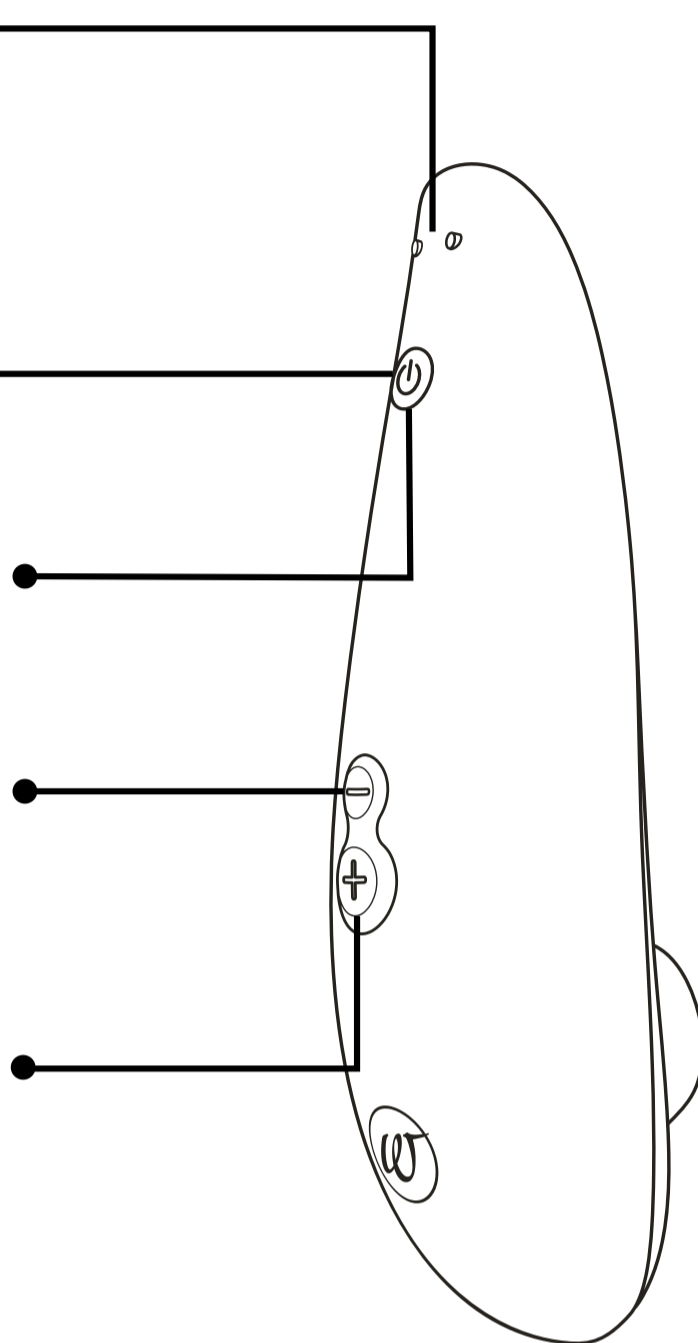

Cabezal estimulador

INDICACIONES DE USO

1. Encender

Pulsa
durante
2 segundos

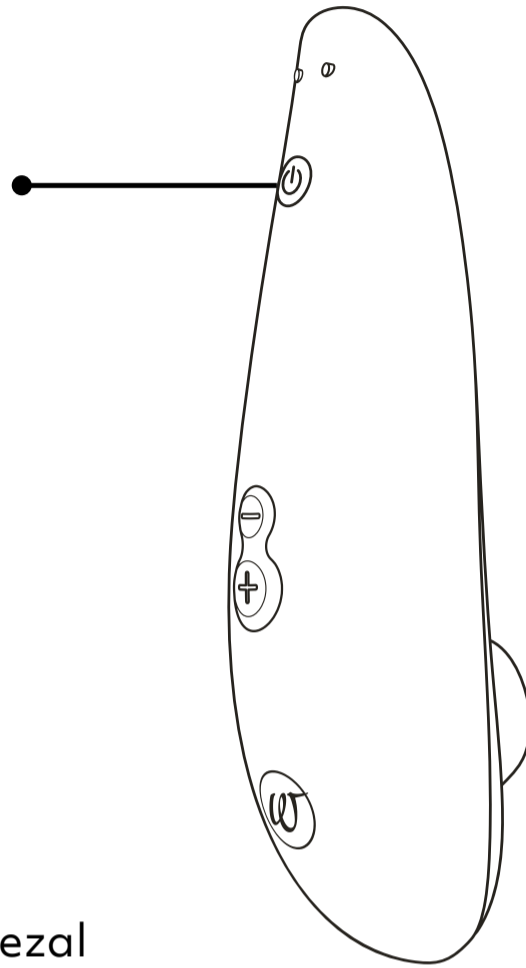

2. Uso

Rodea tu clítoris con el cabezal de estimulación y déjate llevar.

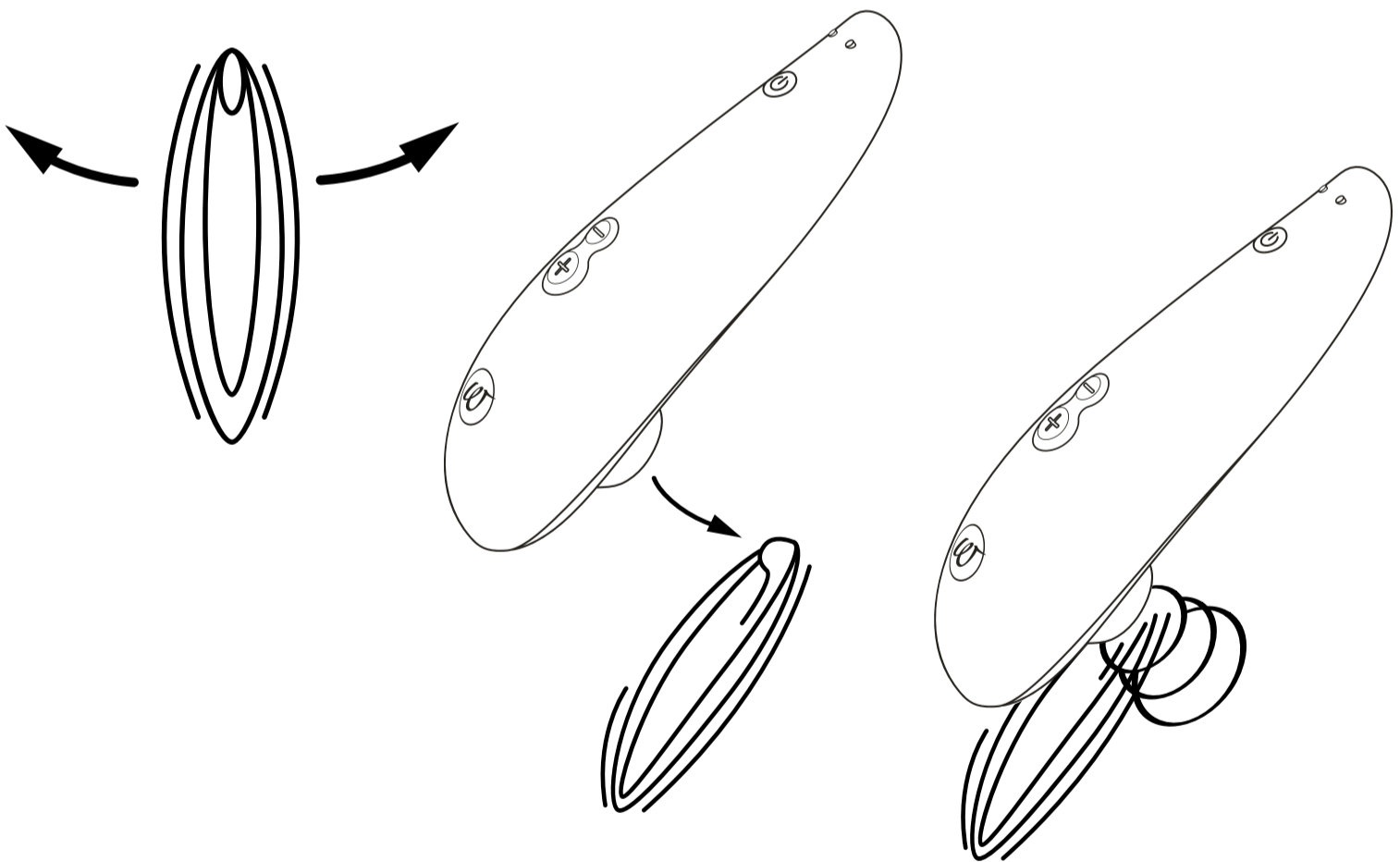

Un pequeño consejo:

Si notas que el cabezal estimulador aún no se ajusta del todo, cambia entre los dos cabezales estimuladores (S o M) incluidos con el dispositivo para que puedas disfrutar de la mejor sensación.

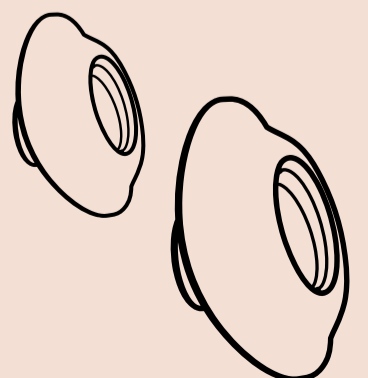

3. Cambiar intensidad

Aumentar
pulsa brevemente

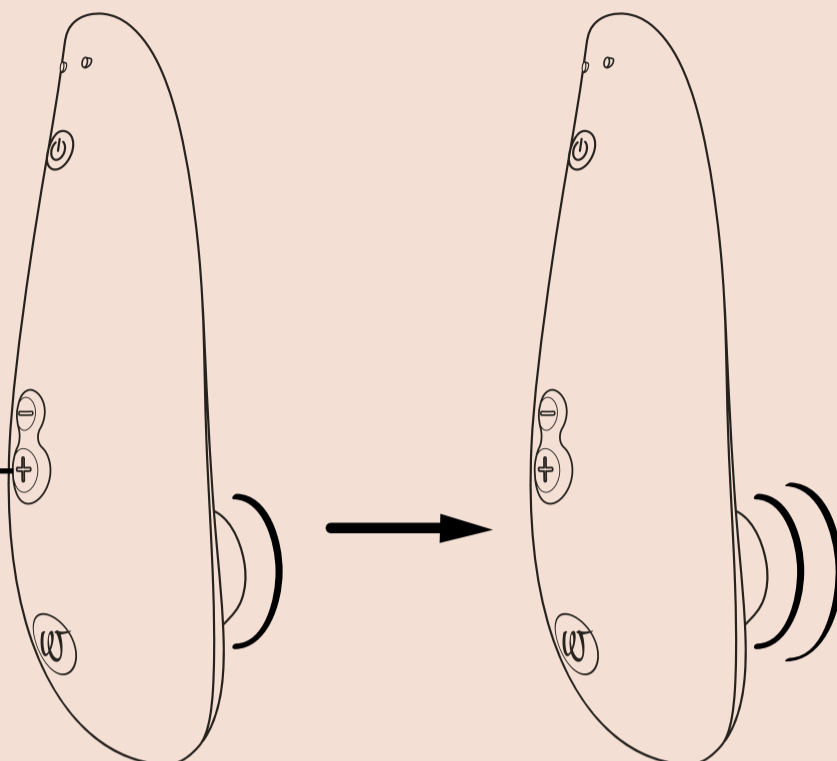

10  **Niveles de intensidad**

Disminuir
pulsa brevemente

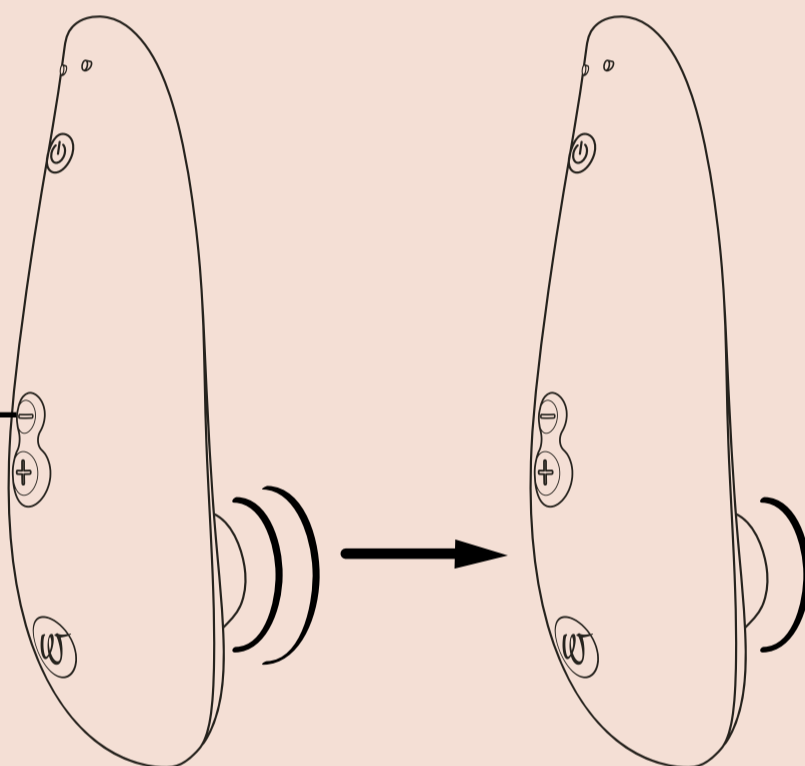

4. Función Afterglow: Pulsa el botón de encendido brevemente para volver al nivel 1 de intensidad.

4. Apagar

pulsa durante
2 segundos

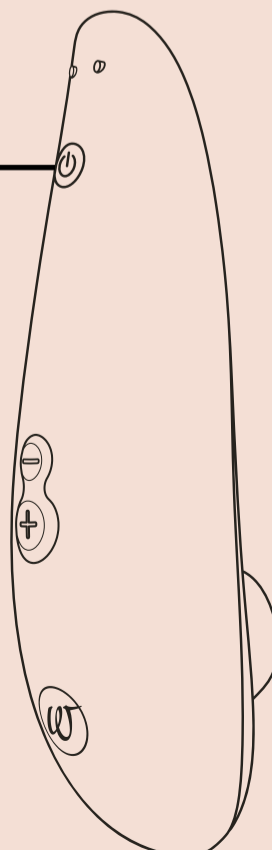

CARGA

Carga el Womanizer antes de usarlo por primera vez. Recuerda cargar tu Womanizer con regularidad, para asegurar una larga duración de la batería.

Carga
a través del puerto USB

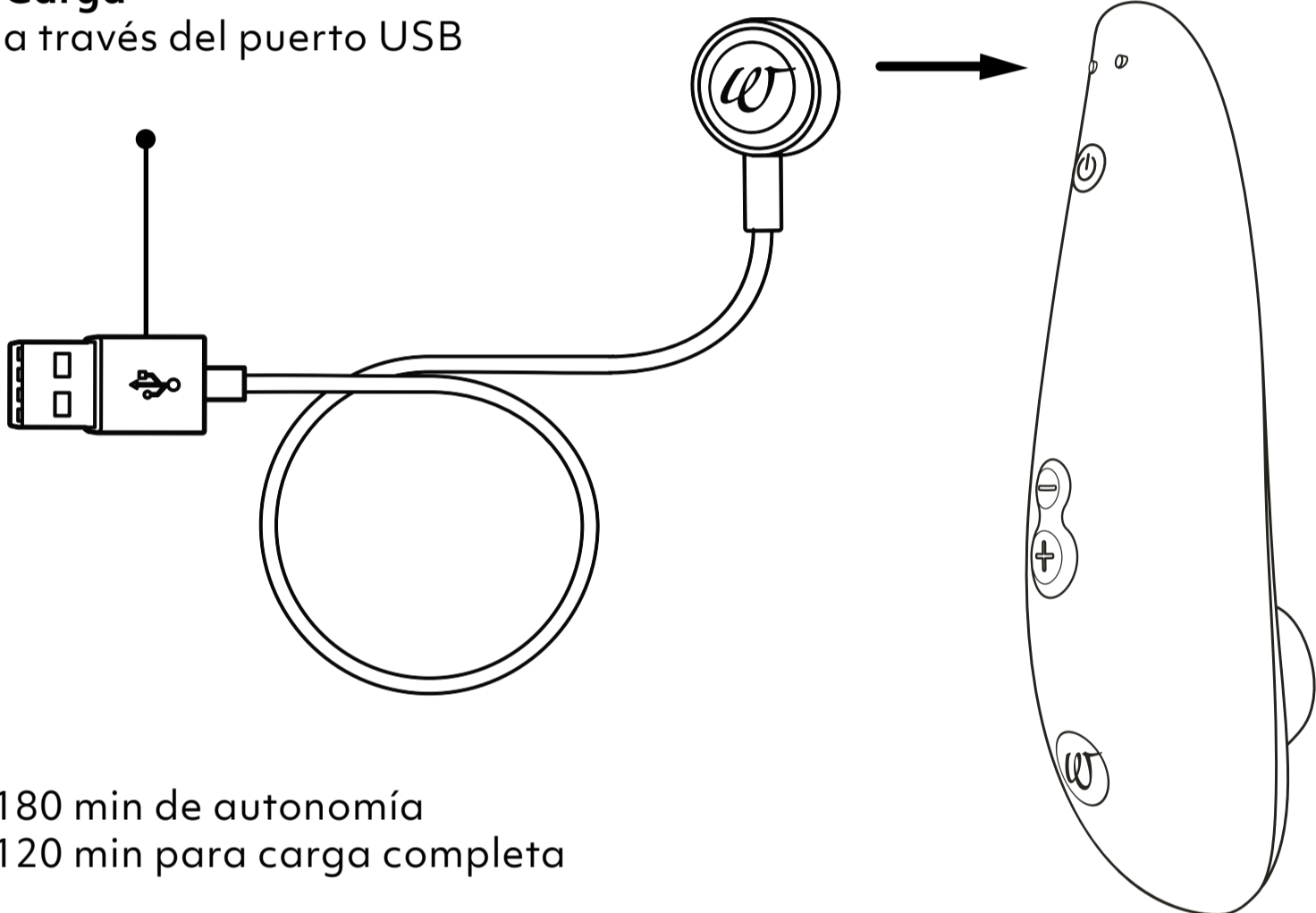

180 min de autonomía
120 min para carga completa

Botón de encendido LED

Nivel de batería

Carga completa

las luces LED se iluminan continuamente

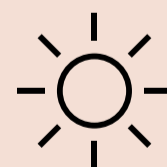

Media carga

la luz LED parpadea rápido

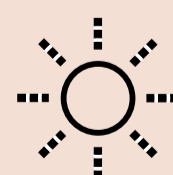

Batería casi agotada

la luz LED parpadea lentamente

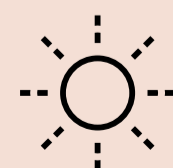

LIMPIEZA

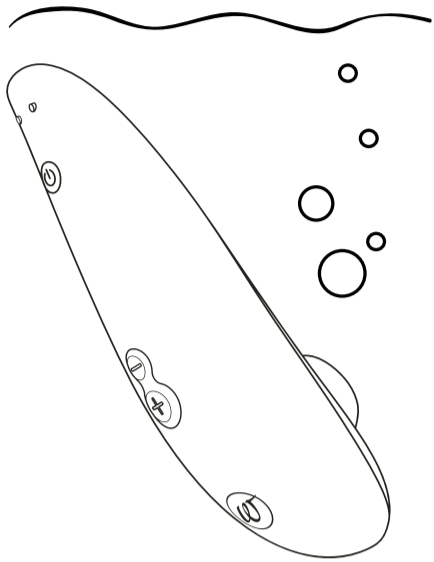

lavar bajo el agua

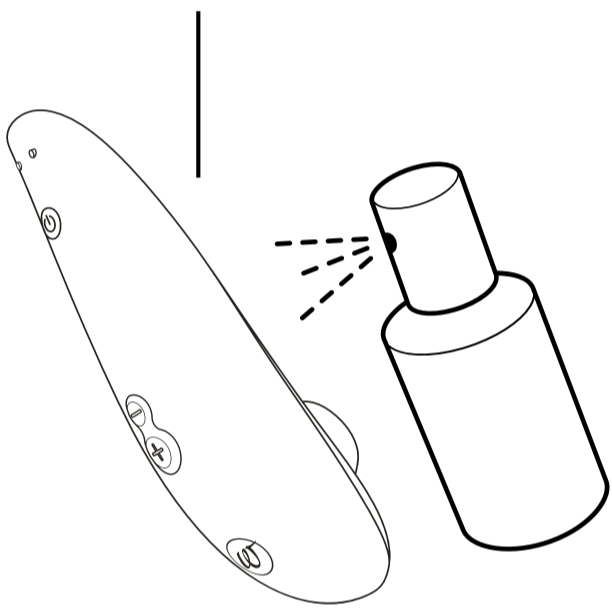

Aplicar un limpia-
dor de juguetes

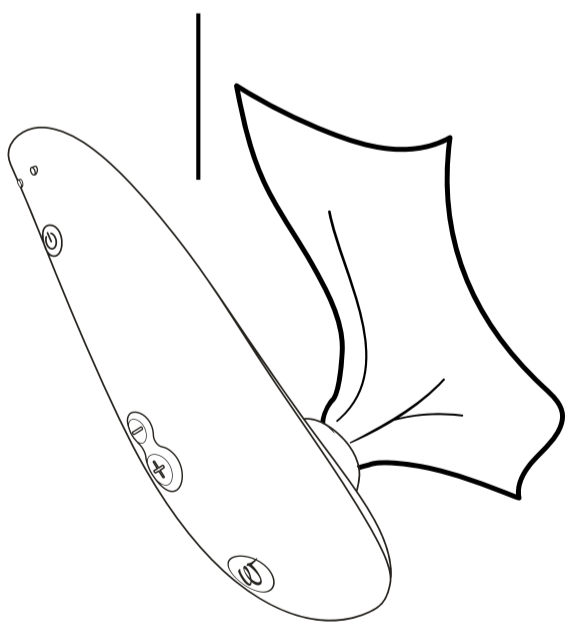

Secar

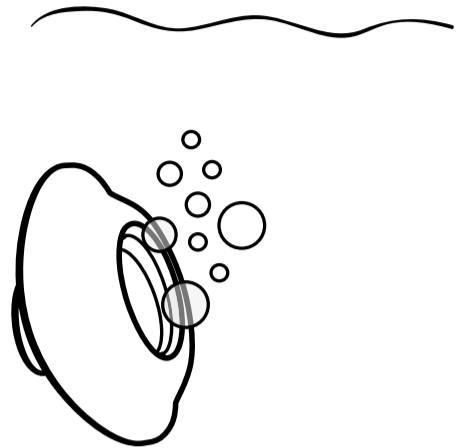

lavar bajo el agua

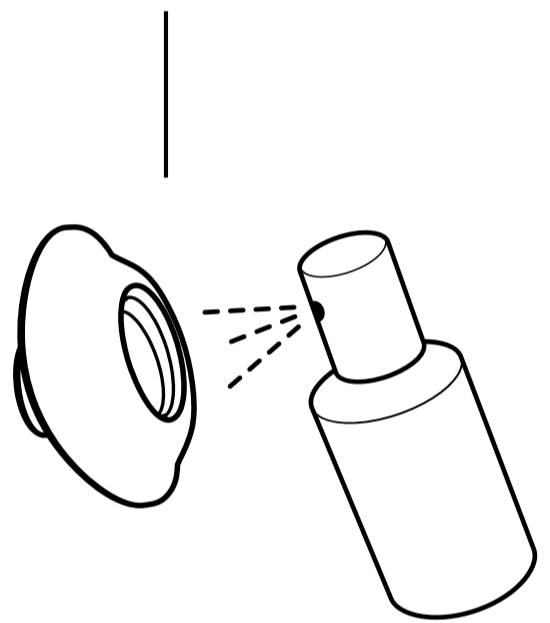

Aplicar un limpia-
dor de juguetes

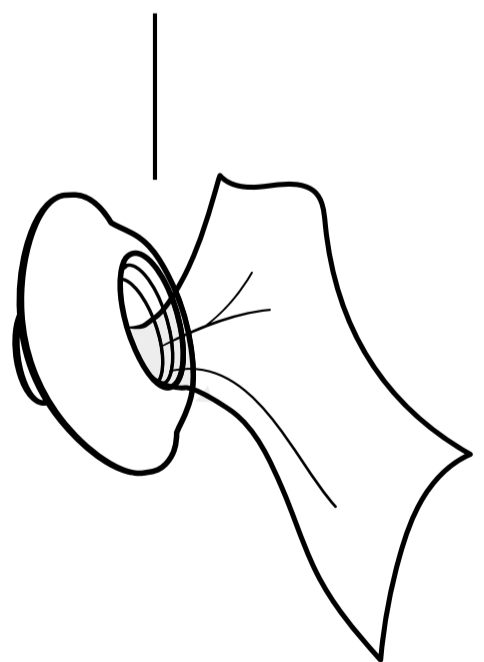

Secar



Waterproof
IPX7

INFORMACIÓN GENERAL

ADVERTENCIA

Lee atentamente las instrucciones de seguridad para saber más.

Limpia a fondo tu Womanizer antes de utilizarlo por primera vez y después de cada uso para reducir el riesgo de infección.

ATENCIÓN AL CLIENTE

Visita nuestro sitio web www.womanizer.com o contacta con nosotros a través de care@womanizer.com para obtener más información.

ESPECIFICACIONES TÉCNICAS

Modelo: WZ08B

Potencia: 100-240 V ~ 50/60 Hz

Salida: 5 V = 0.75 A

Contiene una batería recargable Li-ion.

El adaptador AC/DC no está incluido.

CONTENIDO DEL PAQUETE

Womanizer Classic 2, cable de carga USB, funda de almacenamiento de algodón, 2 cabezales estimuladores, guía de inicio rápido, instrucciones de seguridad.

ALMACENAMIENTO

Guárdalo en un lugar seguro y seco, sin exposición a la luz solar directa.

GARANTÍA Y GARANTÍA VOLUNTARIA DEL FABRICANTE

WOW TECH EUROPE GMBH ofrece a los clientes una garantía voluntaria del cliente para este producto además de la garantía legal a la que tienen derecho los consumidores con respecto a los vendedores.

Las condiciones relativas a la garantía voluntaria del fabricante se encuentran en nuestro sitio web, en el apartado «Condiciones de la garantía».

CUMPLIMIENTO DE LAS NORMAS

Este dispositivo cumple todas las normas relativas a la compatibilidad electromagnética (CEM). El dispositivo es seguro siempre que se utilice correctamente y de acuerdo con las instrucciones de este manual de usuario.

PROTECCIÓN DEL MEDIOAMBIENTE

En calidad de distribuidor de dispositivos electrónicos, estamos obligados por ley a aceptar la devolución de residuos de dispositivos eléctricos y electrónicos de forma gratuita. Declaramos expresamente que como usuario estás legalmente obligado a devolver las baterías usadas. No tires nunca los dispositivos electrónicos ni las baterías a los residuos domésticos. El símbolo que se muestra a continuación y que también aparece en nuestros artículos electrónicos tiene por objeto recordártelo expresamente.

FABRICANTE

WOW Tech Europe GmbH,
Friedenstrasse 91 / 91 a, 10249 Berlín, Alemania

WOW Tech Europe GmbH se reserva el derecho a realizar cambios técnicos y cambios de diseño que sirvan para mejorar el dispositivo.

Distribuido en Norteamérica por WOW TECH Canada Ltd. 1545 Carling Avenue, Suite 401, Ottawa ON, Canadá K1Z 8P9

www.wowtech.com Diseñado en Alemania. Fabricado en China en 2021. Manual publicado en febrero de 2021. Versión 1.

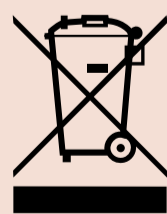

¿AÚN QUIERES MÁS?

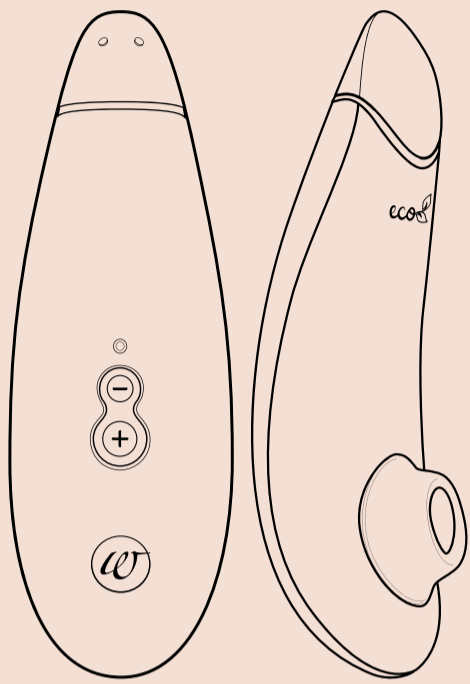

**Pleasure Air
Technology**



Smart Silence



Eco-friendly

Premium eco 

Loving Our Planet Can Be Orgasmic

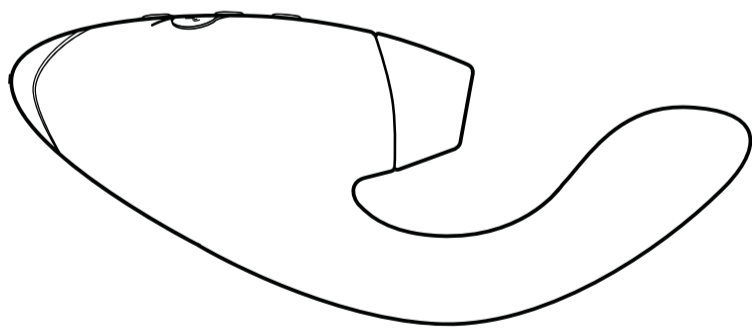

**Pleasure Air
Technology**



Vibrator



Smart Silence

DUO

Double your Pleasure



#IMASTURBATE

Hallo!

Hartelijk dank dat je voor de Womanizer hebt gekozen!

Welkom in een wereld vol sensuele ervaringen die je leven zullen verrijken. Door je keuze van de WOMANIZER zul je niet alleen ongeëvenaarde orgasmen beleven, maar gaat er een heel nieuwe wereld van genot voor je open.

Geniet van je WOMANIZER - orgasme na orgasme.

Ga lekker met jezelf aan de slag!



PRODUCTOMSCHRIJVING

GEBRUIK

OPLADEN

REINIGEN

ALGEMENE INFORMATIE

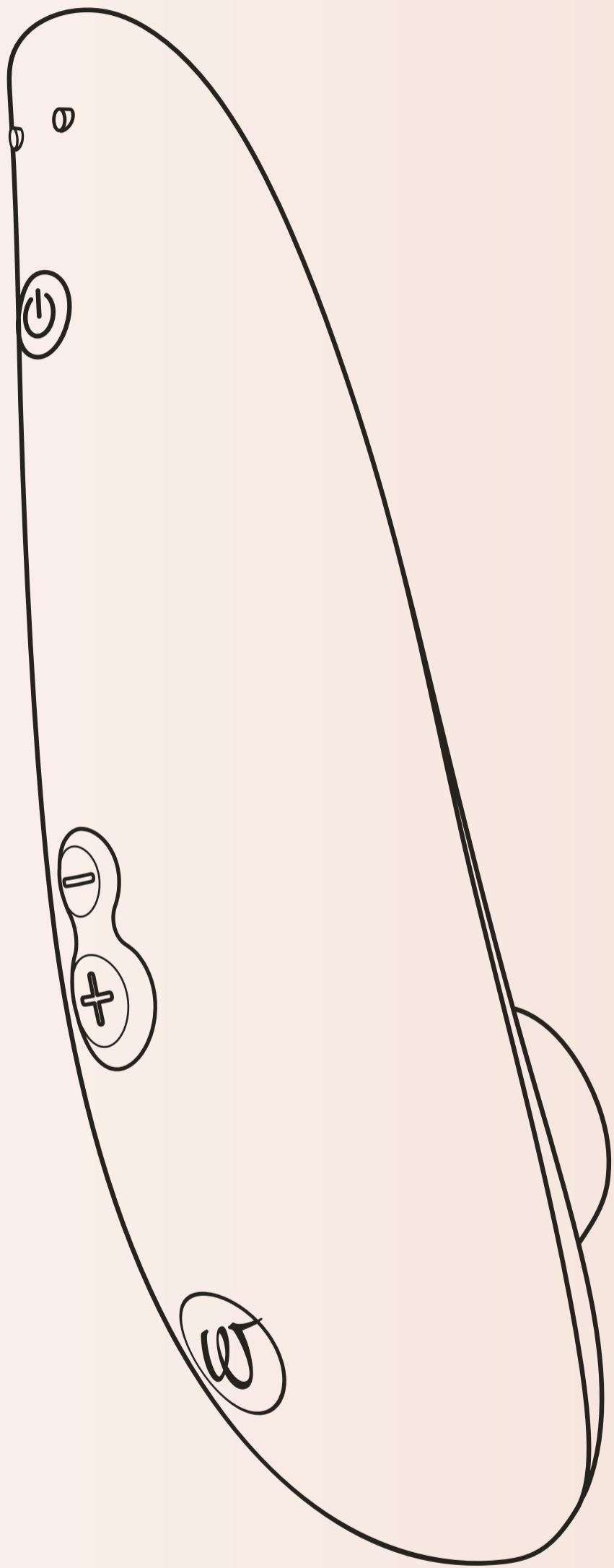

PRODUCTOMSCHRIJVING

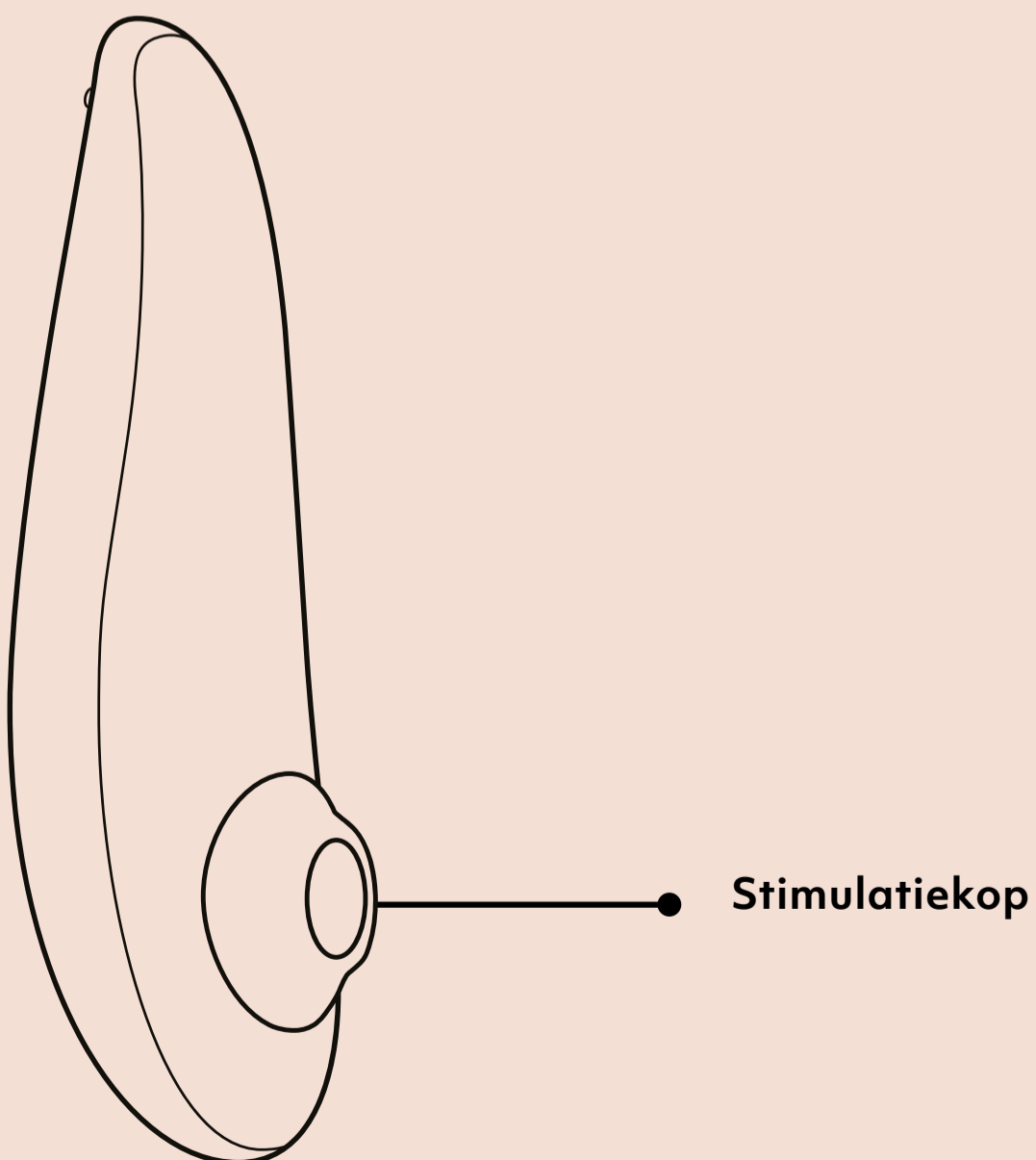
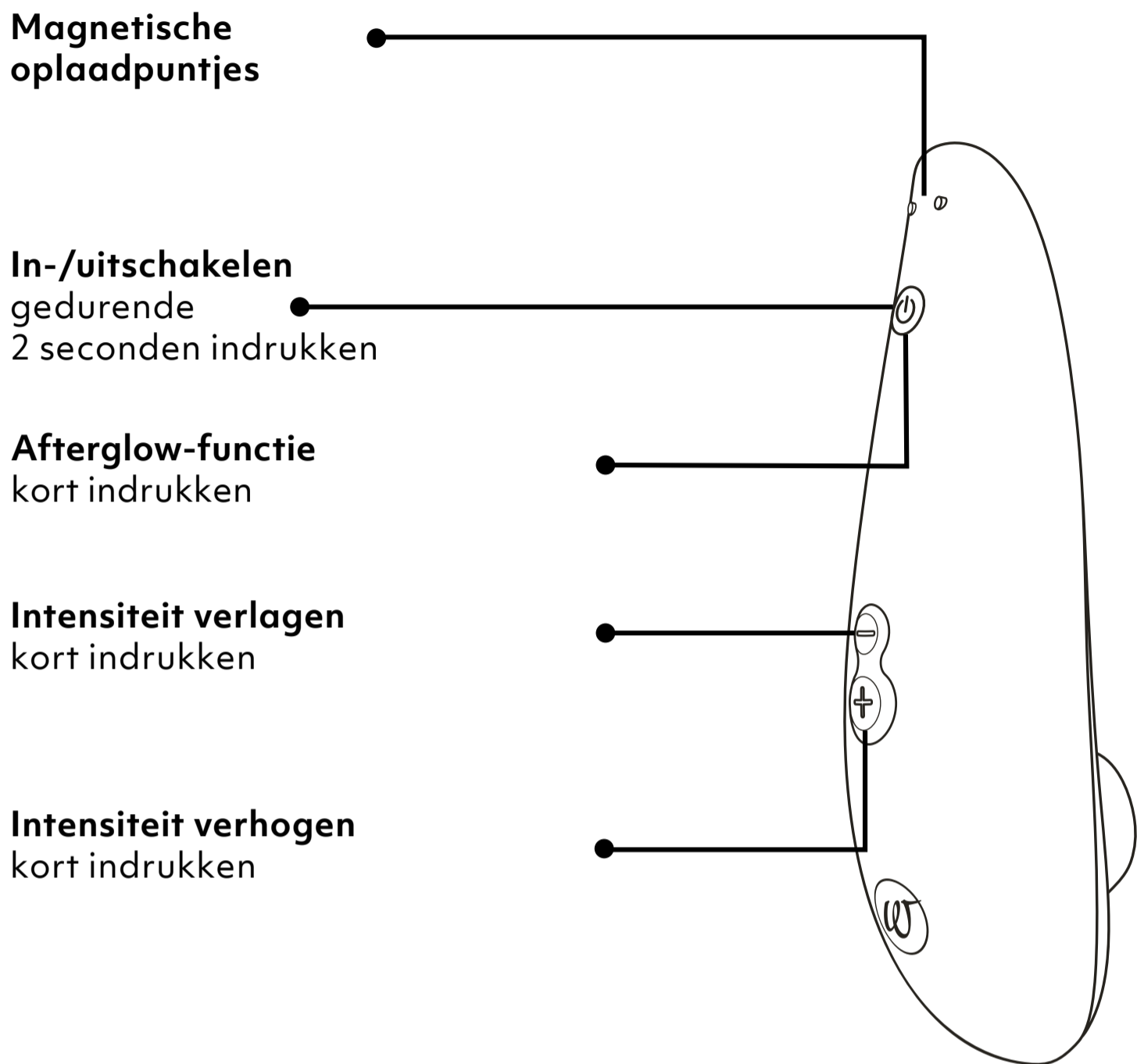

GEBRUIK

1. Inschakelen

Indrukken
gedurende
2 seconden

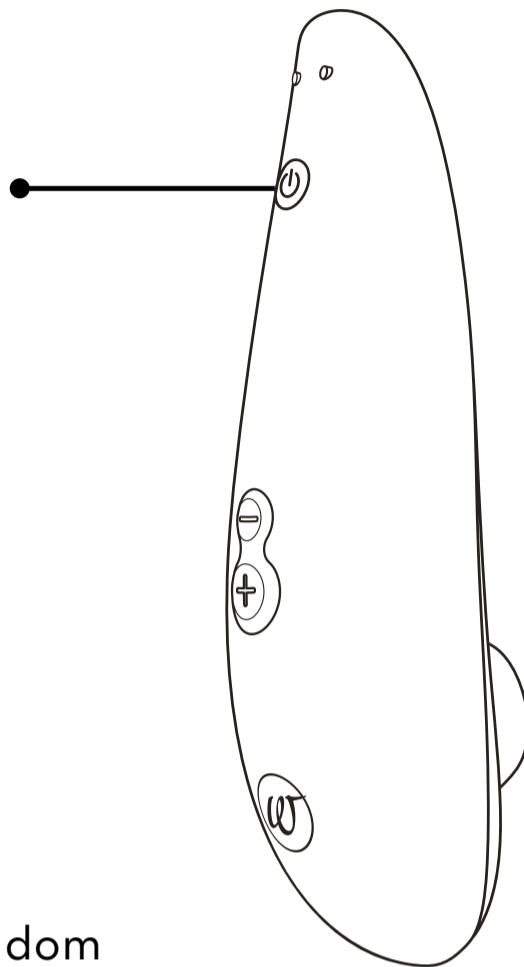

2. Gebruik

Plaats de stimulatiekop rondom
je clitoris en je reis begint.

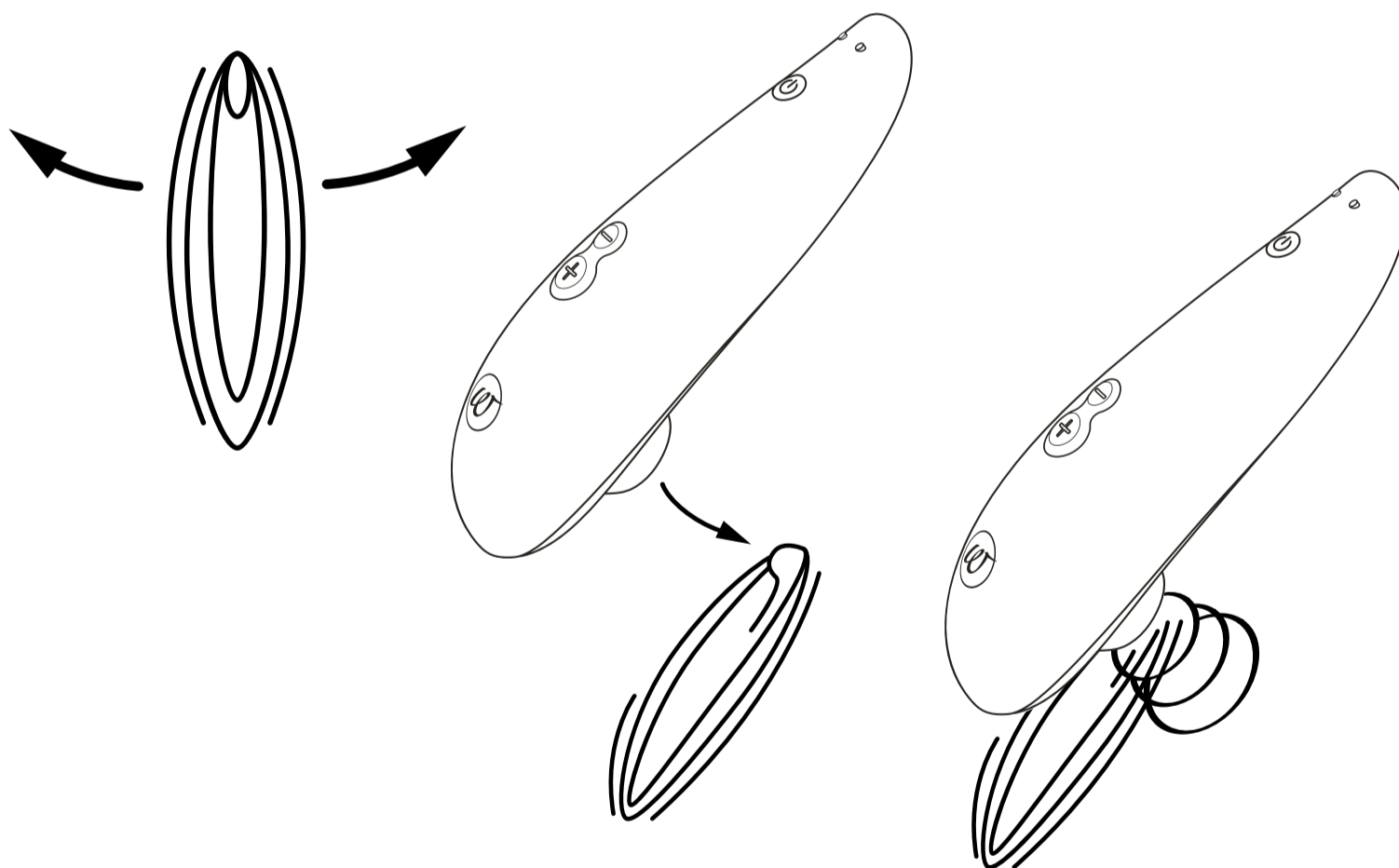

Een kleine tip:

Als je merkt dat het stimulatiekapje nog niet optimaal voelt, kun je wisselen tussen de twee stimulatiekapjes (S of M) die bij het apparaat worden meegeleverd om zo het voor jou lekkerste gevoel te creëren.

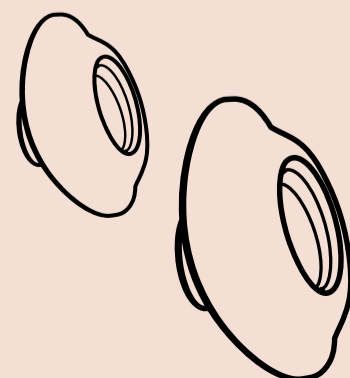

3. Intensiteit veranderen

Verhogen
kort indrukken

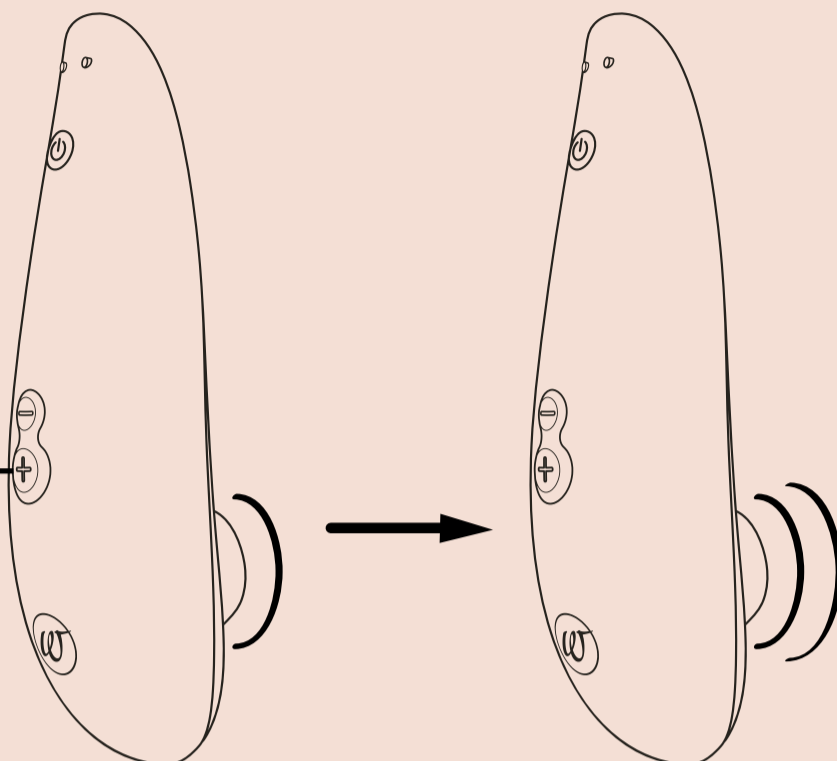

10  **Intensiteits-niveaus**

Verlagen
kort indrukken

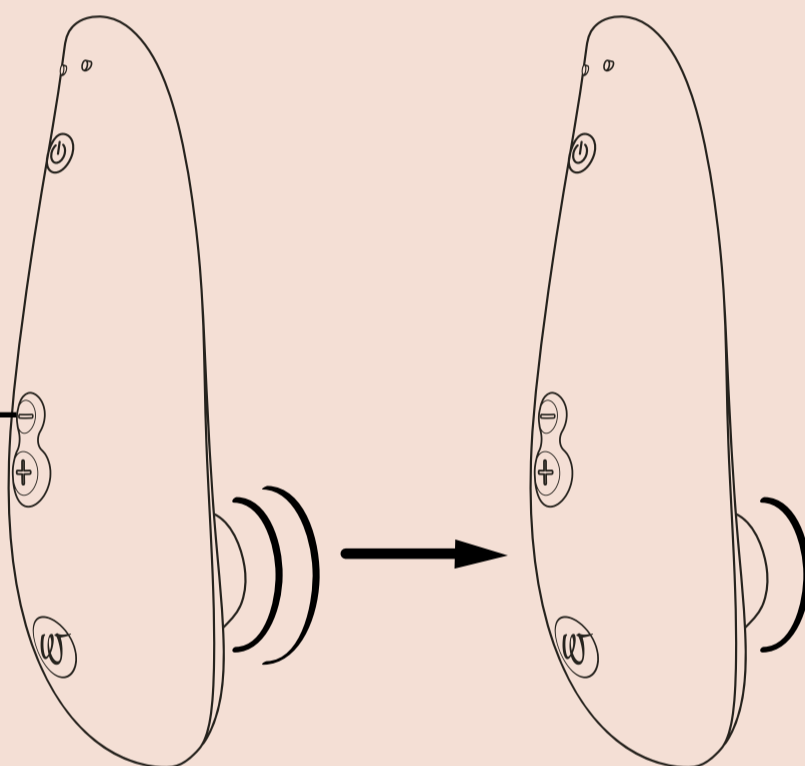

4. Afterglow Feature: Press power button briefly to fall back to intensity level 1.

4. Uitschakelen

indrukken gedurende **2 seconden**

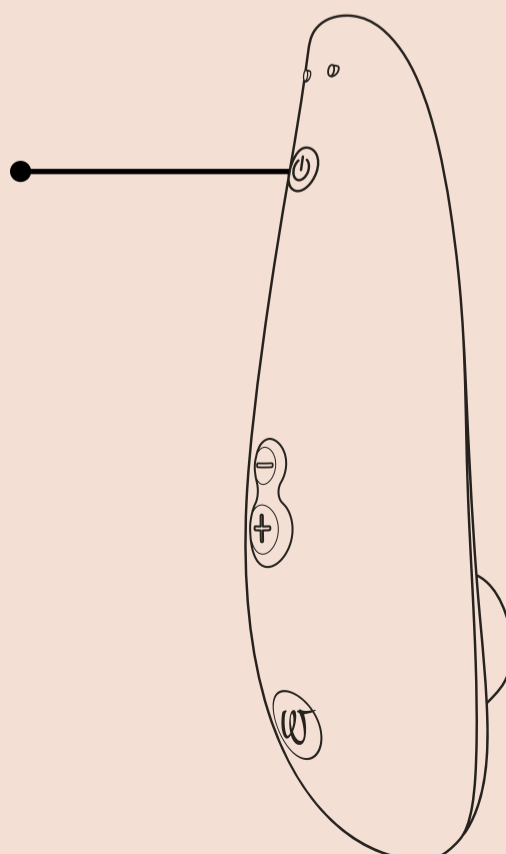

OPLADEN

Laad je Womanizer voor het eerste gebruik op. Vergeet niet de Womanizer regelmatig op te laden, zodat de batterij lang meegaat.

Opladen via USB-poort

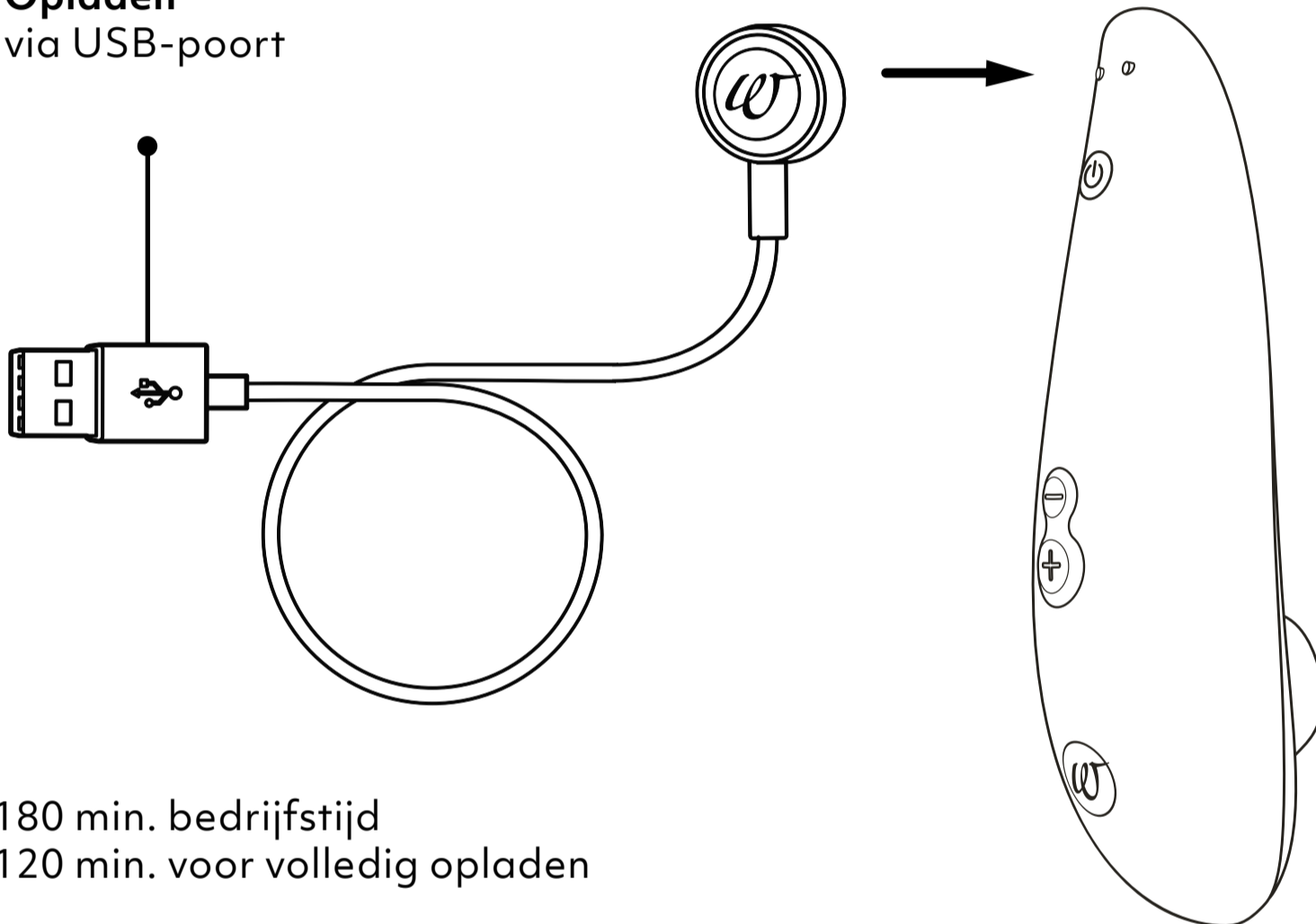

180 min. bedrijfstijd
120 min. voor volledig opladen

Led-aan/uit-knop Batterijniveau

Volledig opgeladen
led brandt continu

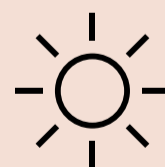

Half opgeladen
led knippert snel

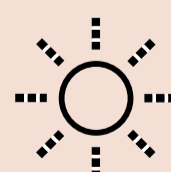

Bijna leeg
led knippert langzaam

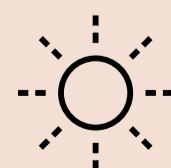

REINIGEN

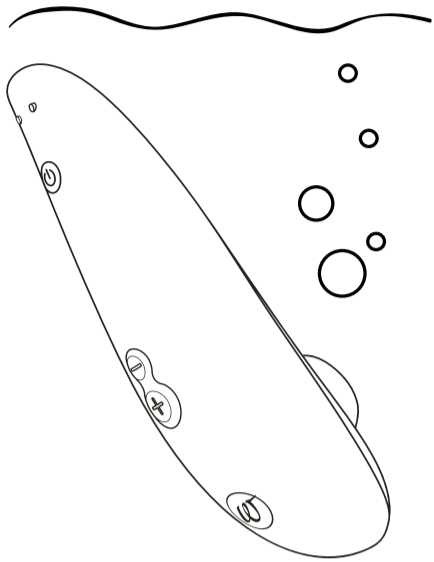

met water
afspoelen



Toy cleaner
aanbrengen

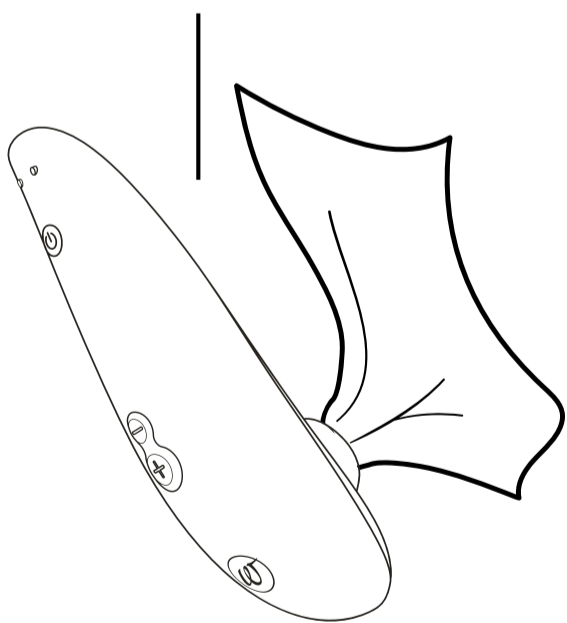

Drogen

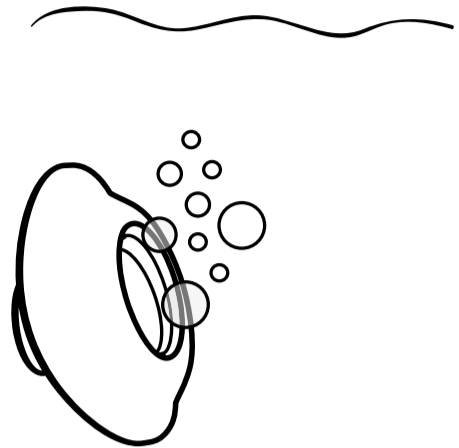

met water
afspoelen

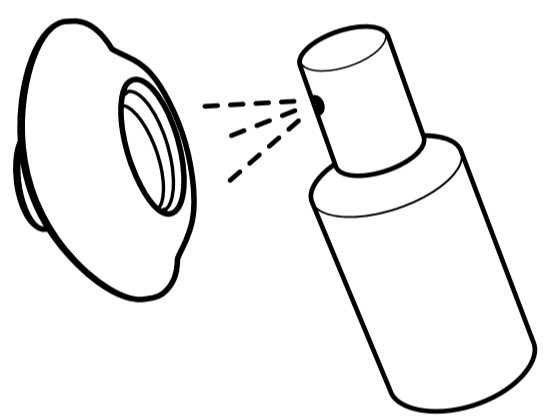

Toy cleaner
aanbrengen

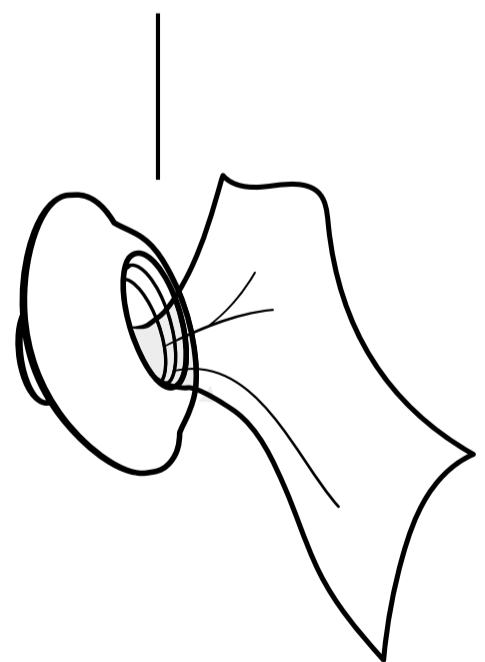

Drogen



Waterproof
IPX7

ALGEMENE INFORMATIE

WAARSCHUWING

Lees de veiligheidsinstructies voor aanvullende informatie zorgvuldig door.

Reinig de Womanizer voor het eerste gebruik grondig. Doe dat ook na elk gebruik om de kans op infectie te verminderen.

KLANTENSERVICE

Kijk voor meer informatie op onze website www.womanizer.com of neem contact op via care@womanizer.com.

TECHNISCHE SPECIFICATIES

Model: WZ08B

Vermogen: 100-240 V ~ 50/60 Hz

Capaciteit: 5 V \approx 0.75 A

Bevat een heroplaadbare li-ion batterij.

Wisselstroomadapter niet inbegrepen.

LEVERINGSOMVANG

Womanizer Classic 2, USB-laadkabel, katoenen opbergzakje, 2 stimulatiekoppen, beknopte handleiding, veiligheidsinstructies.

OPBERGEN

Bewaar het product op een veilige, droge plaats zonder blootstelling aan direct zonlicht.

GARANTIE EN VRIJWILLIGE FABRIEKSGARANTIE

WOW TECH EUROPE GMBH biedt klanten een vrijwillige fabrieksgarantie voor dit product naast de wettelijke garantie door verkopers waar consumenten recht op hebben.

De voorwaarden met betrekking tot deze vrijwillige fabrieksgarantie vind je op onze website onder „Garantievoorwaarden“.

COMPLIANCY MET DE NORMEN

Dit apparaat voldoet aan alle normen met betrekking tot elektromagnetische compatibiliteit (EMC). Het apparaat is veilig te gebruiken zolang het correct wordt gebruikt en volgens de instructies die in deze handleiding worden gegeven.

BESCHERMING VAN HET MILIEU

Als verkoper van elektronische apparatuur zijn wij er wettelijk toe verplicht om de teruggave van afgedankte elektrische en elektronische apparaten kosteloos te accepteren. Wij wijzen je er uitdrukkelijk op dat jij als gebruiker wettelijk verplicht bent om gebruikte batterijen in te leveren. Gooi elektronische apparaten of batterijen nooit weg via het huishoudelijk afval.

Het onderstaande symbool, dat ook op onze elektronische producten staat aangegeven, is uitdrukkelijk bedoeld om je hieraan te herinneren.

FABRIKANT

WOW Tech Europe GmbH,
Friedenstrasse 91 / 91 a, 10249 Berlin, Duitsland

WOW Tech Europe GmbH behoudt het recht technische wijzigingen en wijzigingen aan het design aan te brengen met als doel het apparaat te verbeteren.

Verkocht in Noord-Amerika door WOW TECH Canada Ltd. 1545 Carling Avenue, Suite 401, Ottawa ON, Canada K1Z 8P9

www.wowtech.com Ontworpen in Duitsland. Geproduceerd in China in 2021. Handleiding gepubliceerd in 02/2021. Versie 1.

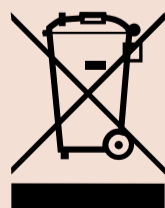

ZIN IN MEER?

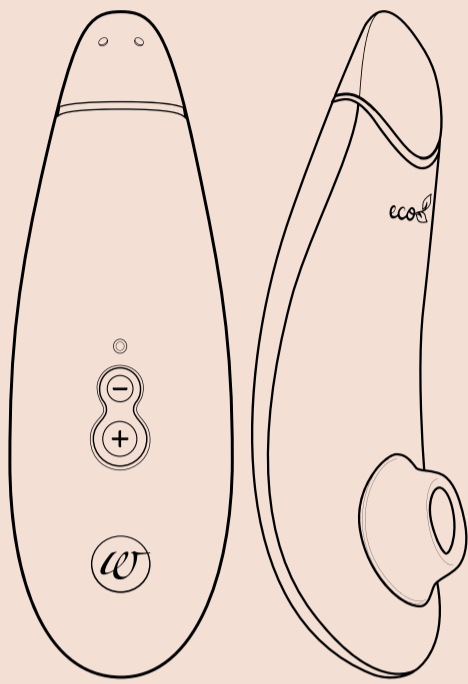

**Pleasure Air
Technology**



Smart Silence



Eco-friendly

Premium eco 

Loving Our Planet Can Be Orgasmic

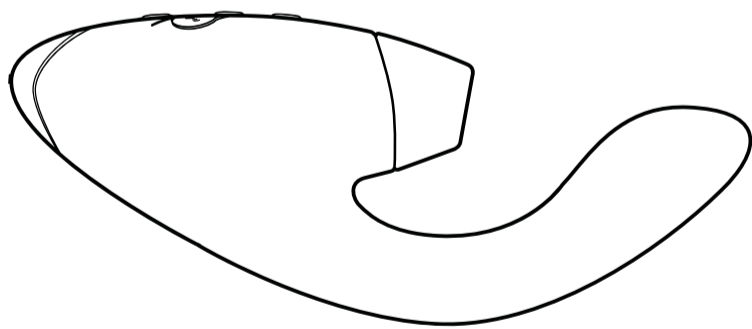

**Pleasure Air
Technology**



Vibrator



Smart Silence

DUO
Double your Pleasure



#IMASTURBATE

Ahoj!

Děkujeme Vám, že jste si vybrali Womanizer!

Vítejte ve světě plném smyslových zážitků, které obohatí Váš život. Výběrem produktu WOMANIZER získáte nejen záruku nepřekonatelného orgasmu, ale také zcela nový zážitek z uspokojení.

Potěšte se s WOMANIZERem – jeden orgasmus za druhým.

Pomilujte se!



POPIS PRODUKTU

JAK PRODUKT POUŽÍVAT

NABÍJENÍ

ČIŠTĚNÍ

OBECNÉ INFORMACE

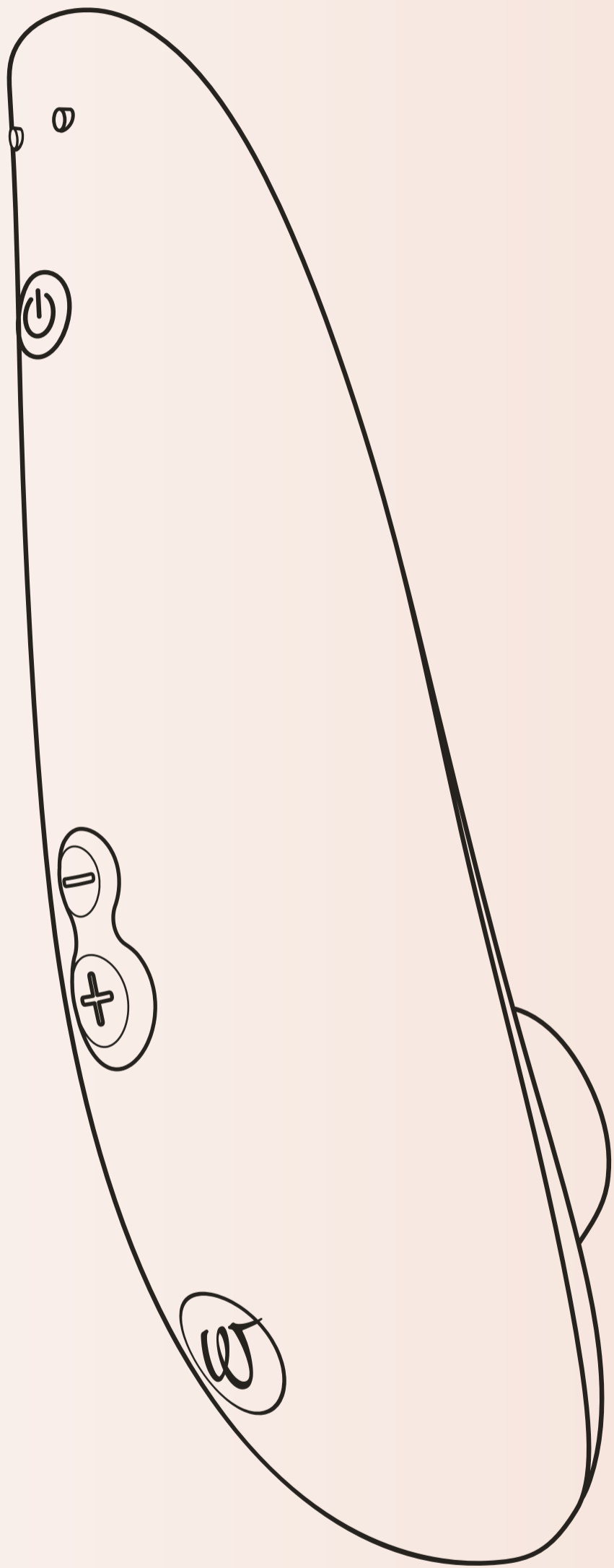

POPIS PRODUKTU

Magnetické nabíjecí konektory

**Zapnutí/
Vypnutí**
na 2 sekundy stiskněte

Funkce Afterglow
krátce stiskněte

Snížení intenzity
krátce stiskněte

Zvýšení intenzity
krátce stiskněte

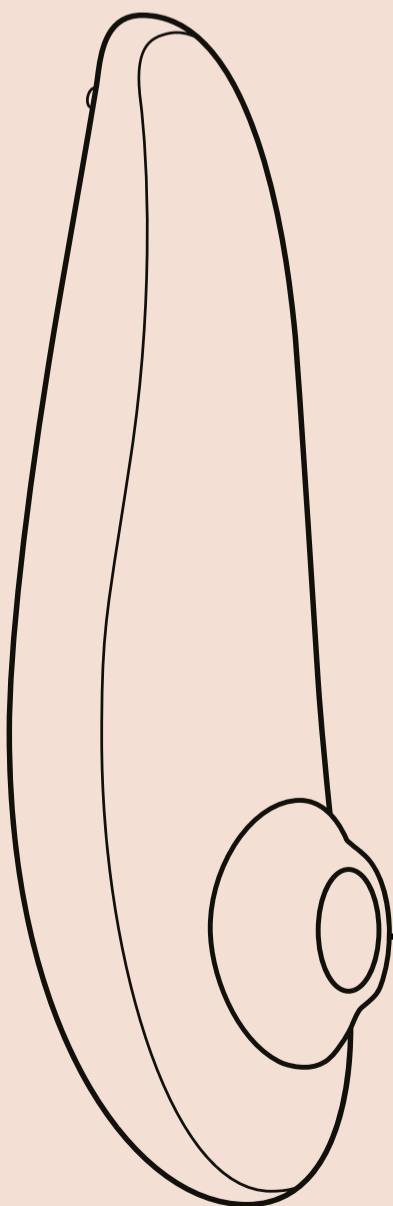
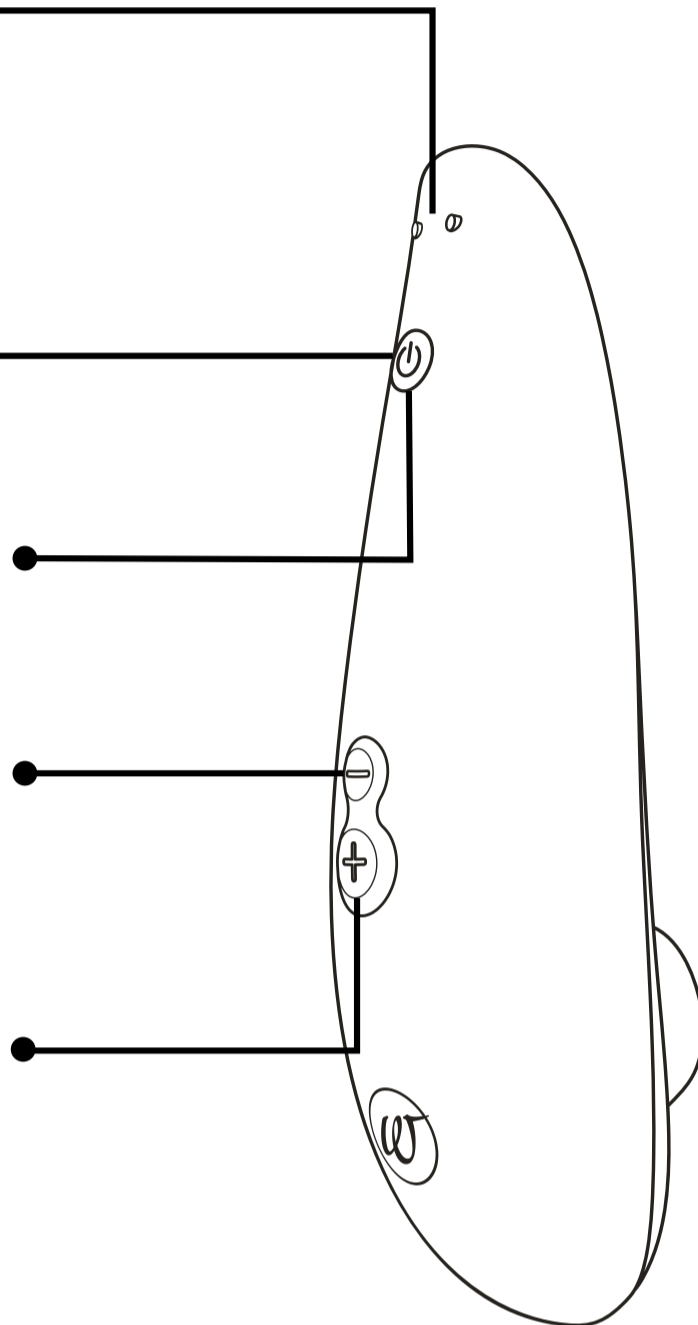

Stimulační hlavice

JAK PRODUKT POUŽÍVAT

1. Zapněte

Stiskněte
a podržte
stisknuté
2 sekundy

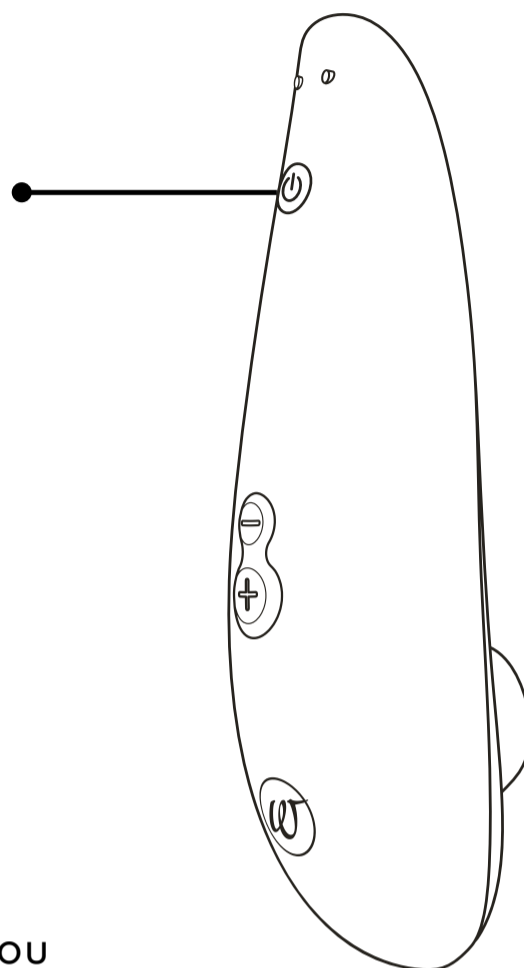

2. Použití

Obklopte klitoris stimulačnou
hlavicou a vaša cesta sa začína.

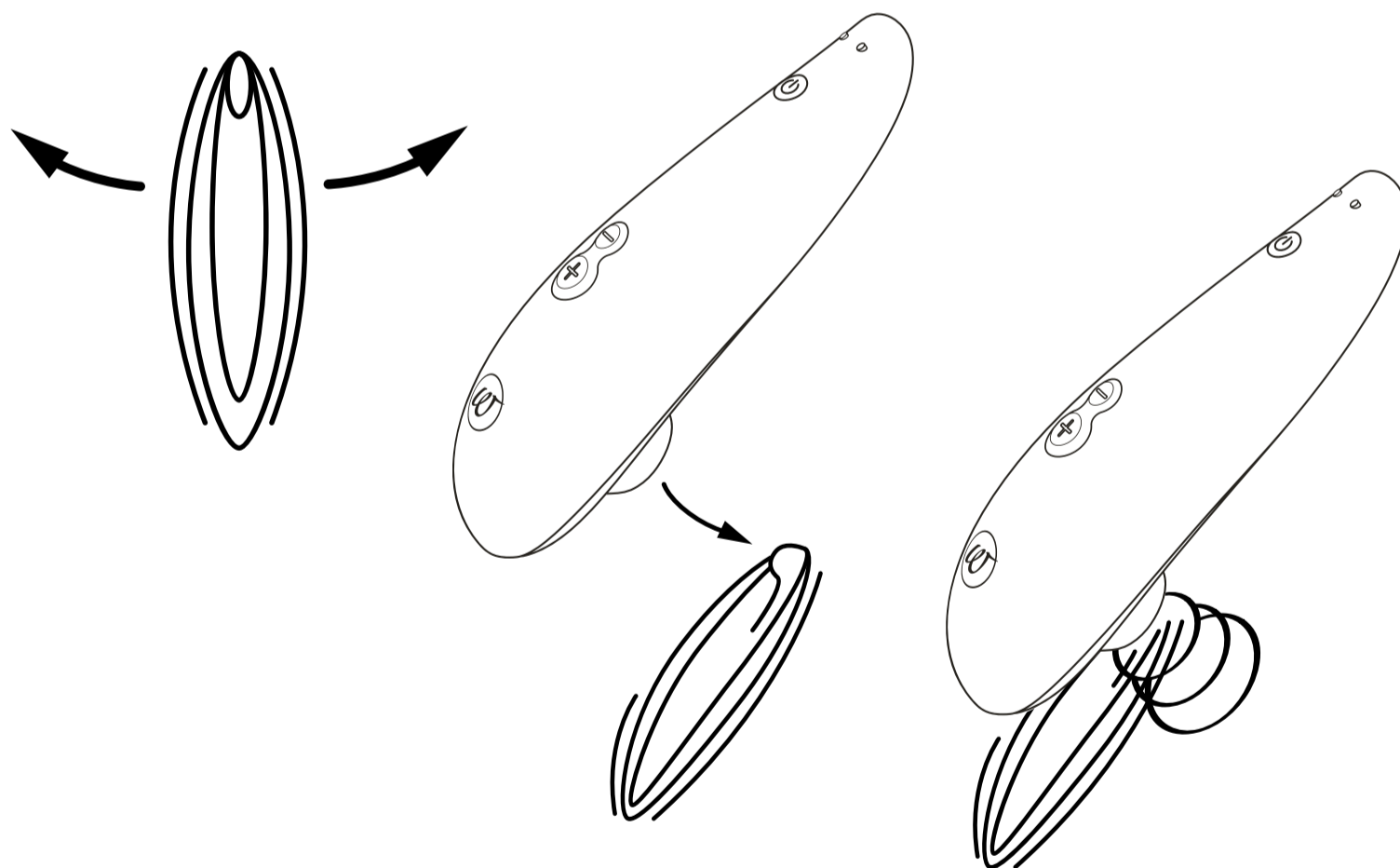

Malý tip:

Pokud zaznamenáte, že stimulační nástavec není optimální, zkuste zaměnit dva stimulační nástavce (S nebo M), jimiž zařízení disponuje, abyste dosáhli maximálního pocitu uspokojení.

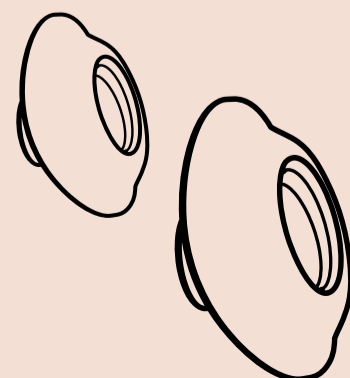

3. Změna intenzity

Zvýšení
krátce stiskněte

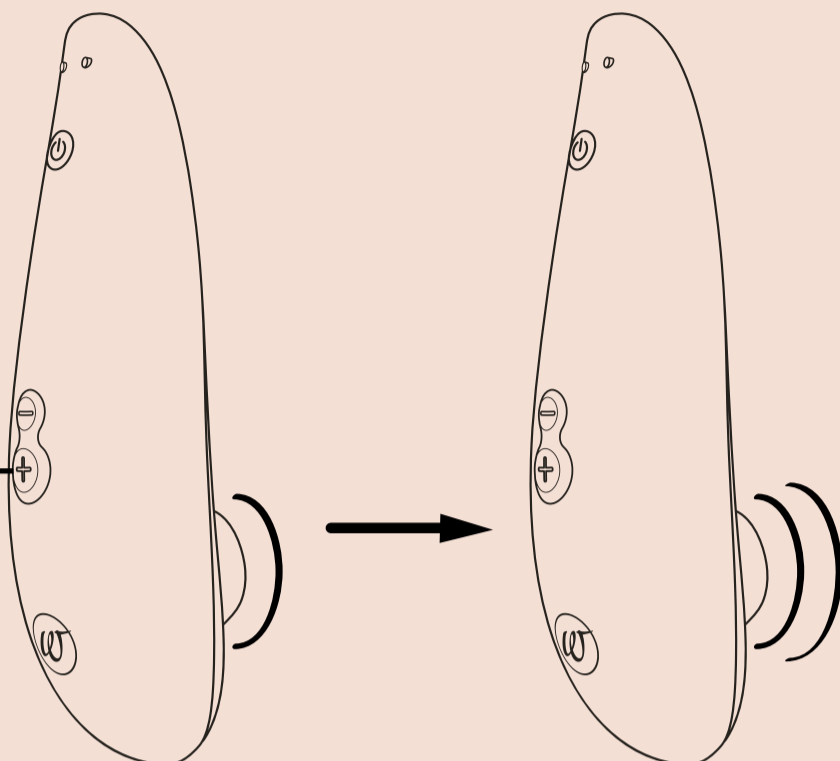

10  Úrovně
intenzity

Snížení
krátce stiskněte

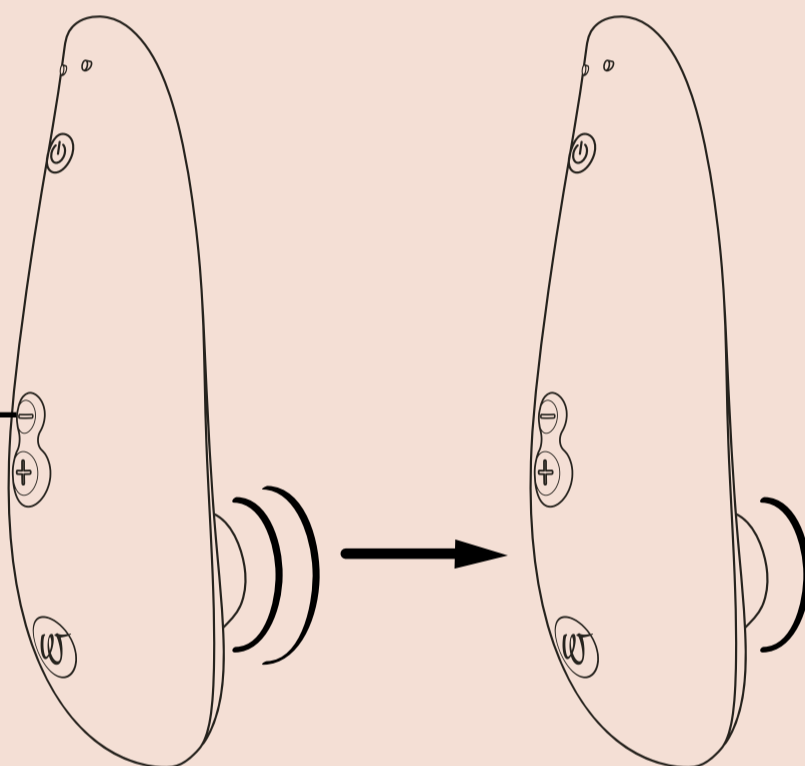

4. **Afterglow Feature:** Press power button briefly to fall back to intensity level 1.

4. Vypnutí

stiskněte
a podržte na
2 sekundy

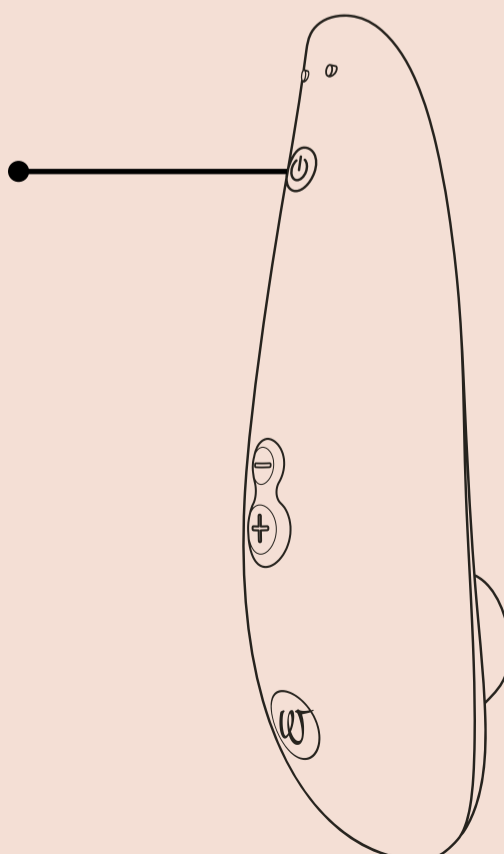

NABÍJENÍ

Před prvním použitím produkt Womanizer nabijte. Také nezapomeňte nabíjet produkt Womanizer pravidelně, abyste zajistili dlouhou životnost baterie.

Nabíjení přes USB port

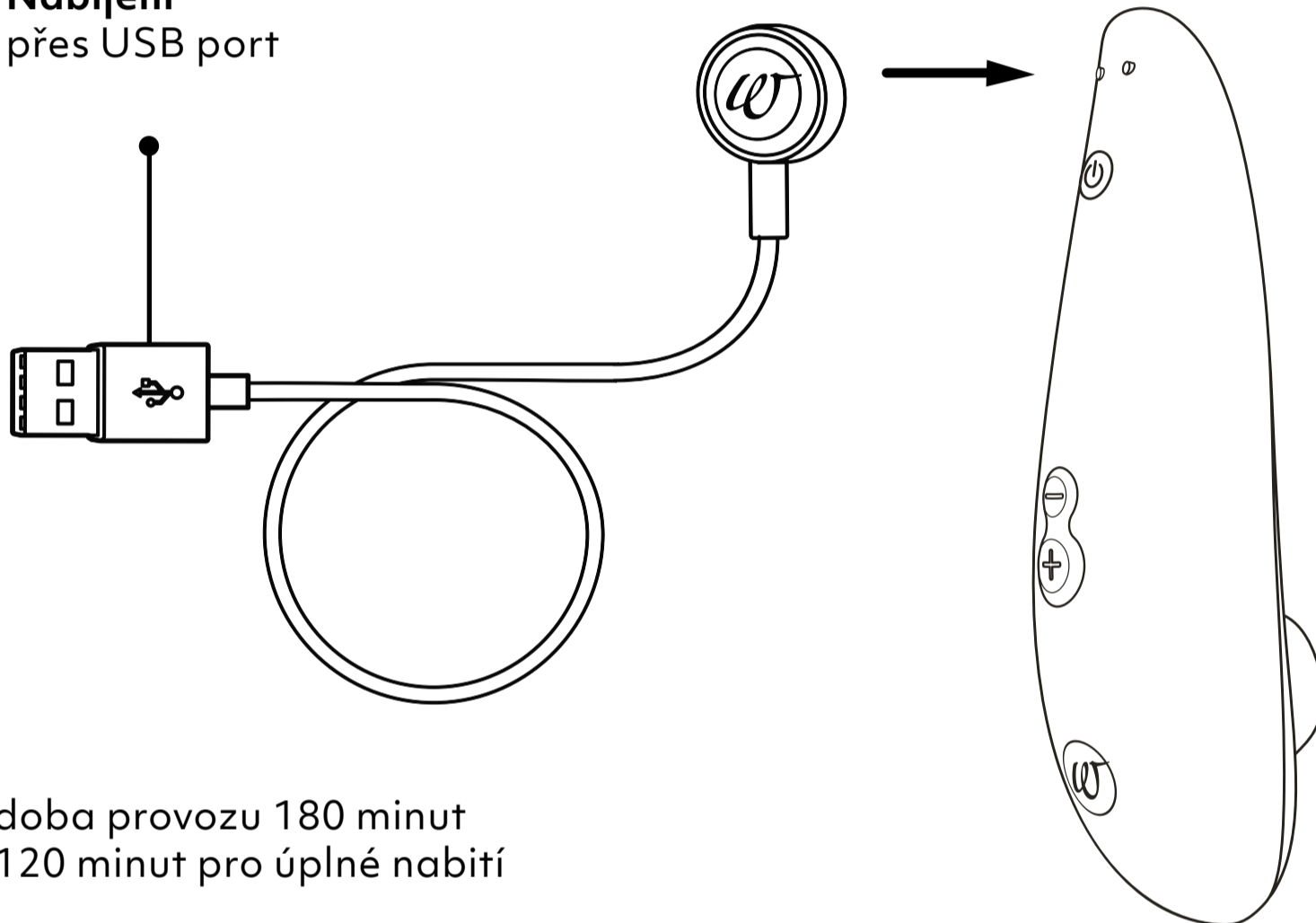

doba provozu 180 minut
120 minut pro úplné nabití

Vypínač s kontrolkou LED

Úroveň nabití baterie

Úplně nabitá

kontrolka led svítí

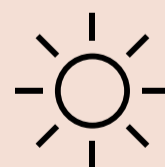

Z poloviny nabitá

kontrolka led rychle bliká

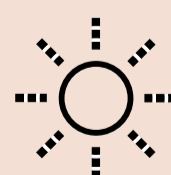

Téměř vybitá

kontrolka led bliká pomalu

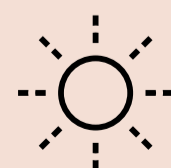

ČIŠTĚNÍ

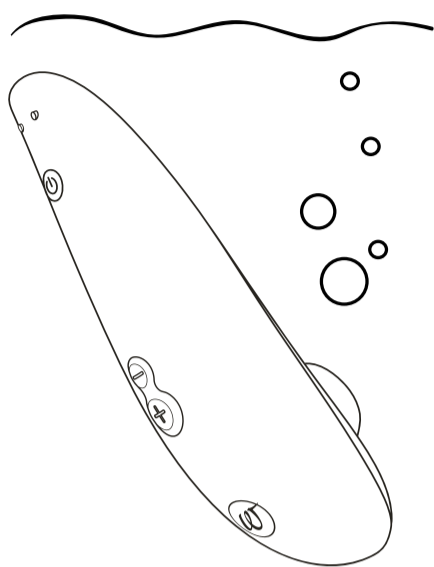

opláchněte pod
tekoucí vodou

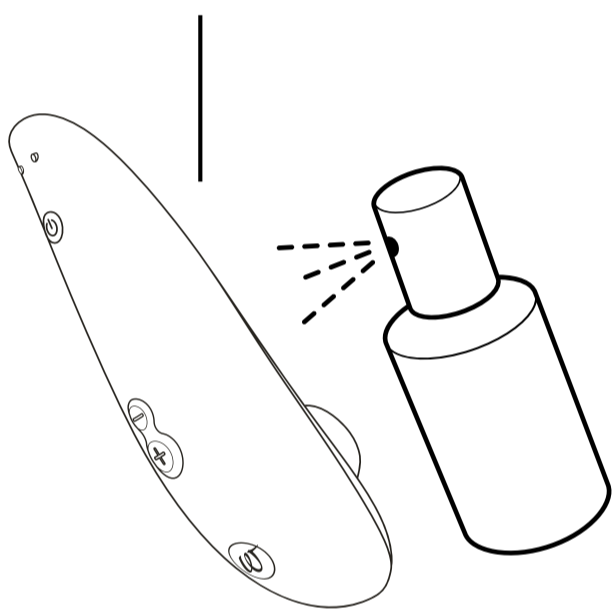

Použijte čistič
hraček

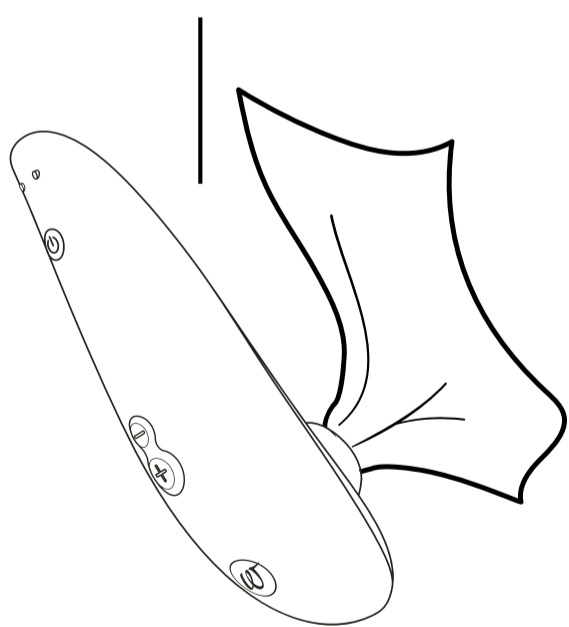

Usušte

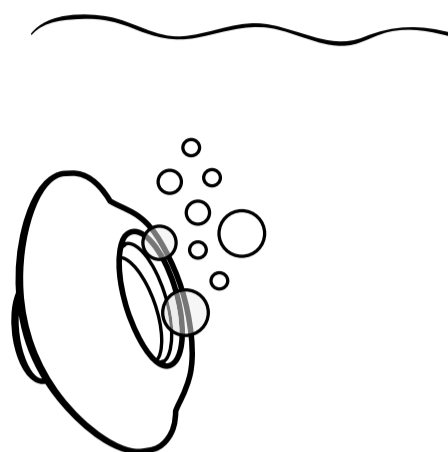

opláchněte pod
tekoucí vodou

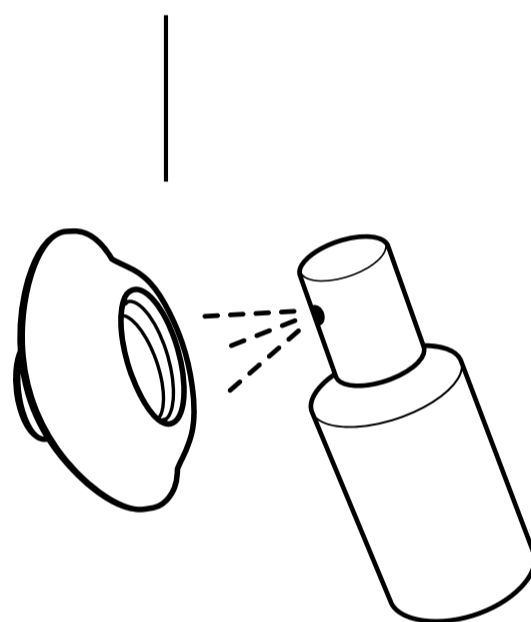

Použijte čistič
hraček

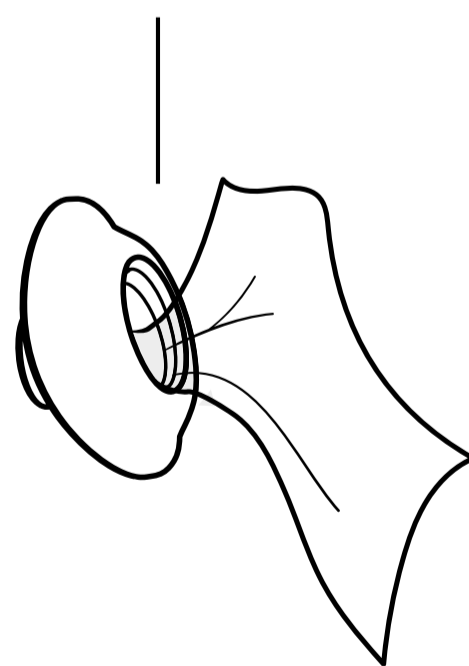

Usušte

+



Waterproof
IPX7

OBEČNÉ INFORMACE

VAROVÁNÍ

Seznamte se důkladně s bezpečnostními pokyny, kde jsou uvedeny další informace.

Před prvním použitím a po každém dalším použití Womanizer důkladně vyčistěte, abyste snížili riziko infekce.

PÉČE O ZÁKAZNÍKY

Pro další informace navštivte, prosím, naši webovou stránku www.womanizer.com nebo nás kontaktujte na care@womanizer.com.

TECHNICKÉ ÚDAJE

Model: WZ08B

Jmenovitý výkon: 100–240 V ~
50/60 Hz

Výstup: 5 V $\overline{=}$ 0.75 A

Obsahuje lithium-iontovou dobíjecí baterii.

Adaptér AC/DC není součástí dodávky.

ROZSAH DODÁVKY

Womanizer Classic 2, nabíjecí kabel USB, bavlněné úložné pouzdro, 2 stimulační hlavice, stručný návod, bezpečnostní pokyny.

SKLADOVÁNÍ

Skladujte na bezpečném, suchém místě bez vystavení účinkům přímého slunečního záření.

ZÁRUKA A DOBROVOLNÁ ZÁRUKA VÝROBCE

Společnost WOW TECH EUROPE GMBH nabízí zákazníkům na tento produkt nad rámec zákonné záruky, na kterou mají spotřebitelé nárok, dobrovolnou záruku výrobce.

Podmínky týkající se dobrovolné záruky výrobce jsou uvedeny na naší webové stránce v části „Záruční podmínky“.

PLNĚNÍ STANDARDŮ

Tento spotřebič splňuje všechny normy týkající se elektromagnetické kompatibility (EMC). Zařízení je bezpečné při použití, pokud je používáno správně a v souladu s pokyny uvedenými v tomto návodu.

OCHRANA ŽIVOTNÍHO PROSTŘEDÍ

Jako distributor elektronických zařízení máme zákonem uloženou povinnost bezplatně přijímat vrácená elektrická a elektronická zařízení.

Výslovně uvádíme, že Vy jako uživatel jste povinni vrátit použité baterie. Elektronická zařízení ani baterie nikdy nevyhazujte do domácího odpadu.

Tuto skutečnost Vám má výslovně připomenout níže uvedený symbol, který je také umístěný na elektronických prvcích.

VÝROBCE

WOW Tech Europe GmbH,
Friedenstrasse 91 / 91 a, 10249 Berlin, Německo

Společnost WOW Tech Europe GmbH si vyhrazuje právo provádět technické a konstrukční změny, které slouží ke zlepšení zařízení.

Distribučováno v Severní Americe společnostmi WOW TECH Canada Ltd.
1545 Carling Avenue, Suite 401, Ottawa ON, Canada K1Z 8P9

www.wowtech.com Navrženo v Německu. Vyrobeno v Číně v roce 2021. Příručka vydána v 02/2021. Verze 1.

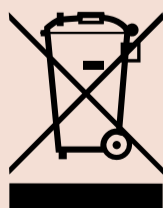

STÁLE NEJSTE SPOKOJENI?

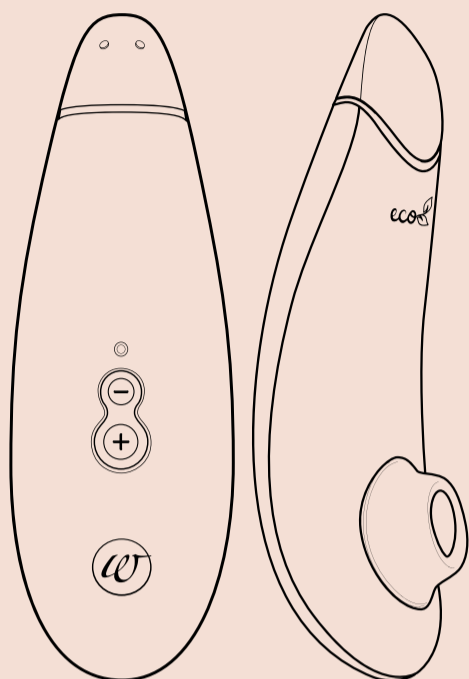

**Pleasure Air
Technology**



Smart Silence



Eco-friendly

Premium eco 

Loving Our Planet Can Be Orgasmic

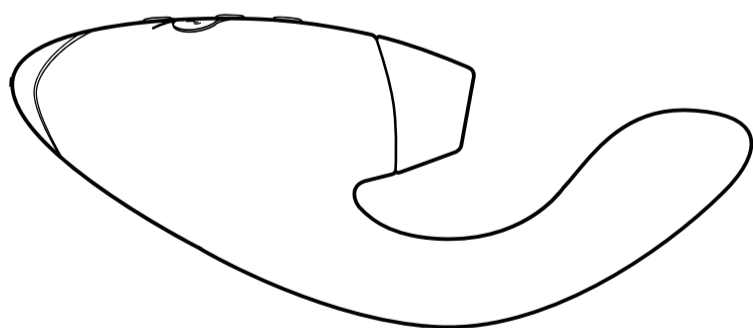

**Pleasure Air
Technology**



Vibrator



Smart Silence

DUO

Double your Pleasure

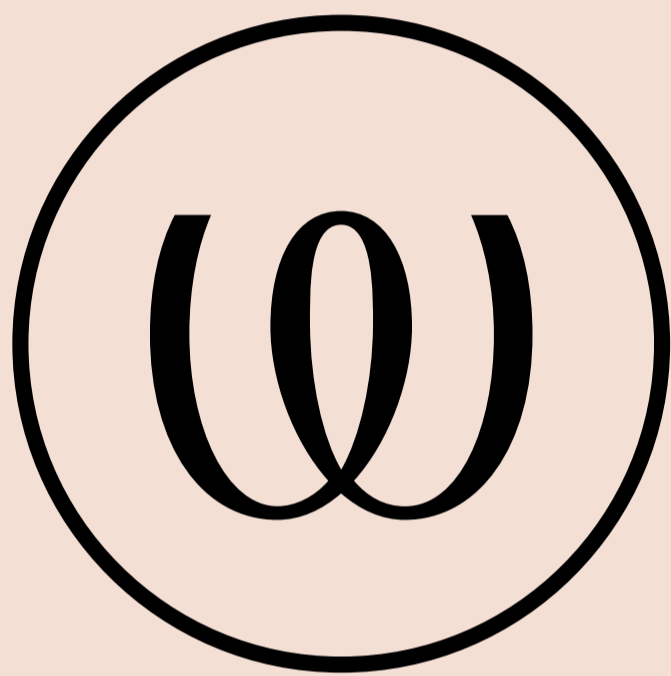

#IMASTURBATE

Привет!

Womanizer - правильный выбор!

Добро пожаловать в мир, полный чувственных удовольствий, способных обогатить твою жизнь. WOMANIZER гарантирует тебе не только несравнимые оргазмы, но и совершенно новое качество удовольствия.

Позволь WOMANIZER подарить тебе один оргазм за другим.

Займись с собой любовью!



ОПИСАНИЕ ИЗДЕЛИЯ

ИНСТРУКЦИЯ ПО ИСПОЛЬЗОВАНИЮ

ЗАРЯДКА

ОЧИСТКА

ОБЩАЯ ИНФОРМАЦИЯ

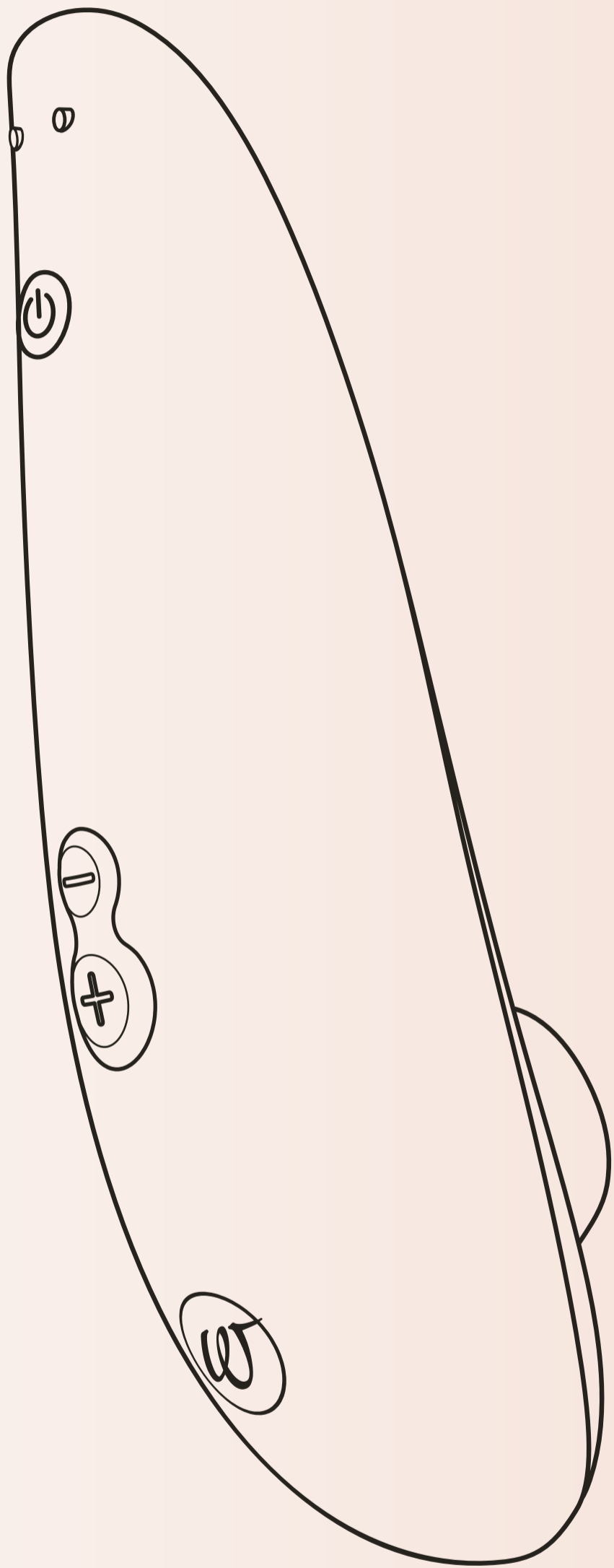

ОПИСАНИЕ ИЗДЕЛИЯ

Магнитная зарядка

Вкл./Выкл.

Удерживай кнопку нажатой в течение 2 секунд

Afterglow Feature

Коротко нажми на кнопку

Уменьшить интенсивность

Коротко нажми на кнопку

Увеличить интенсивность

Коротко нажми на кнопку

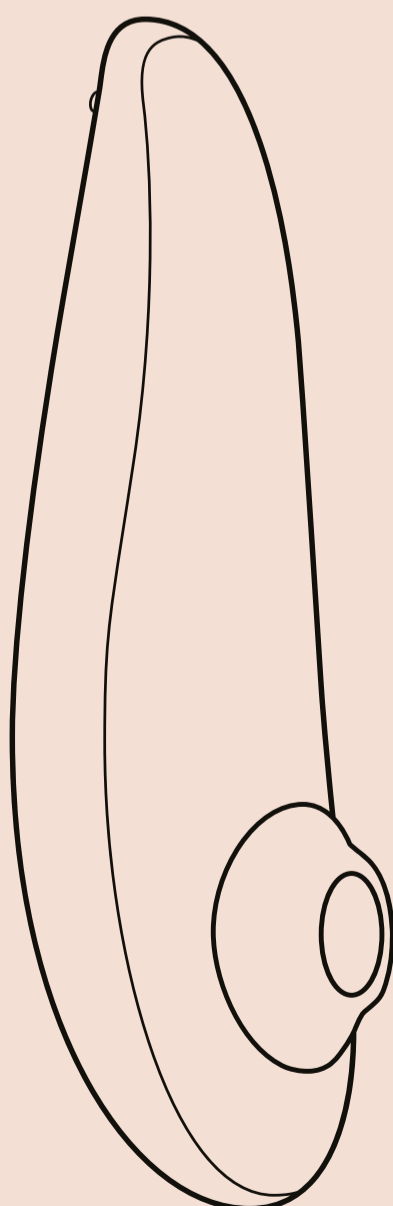
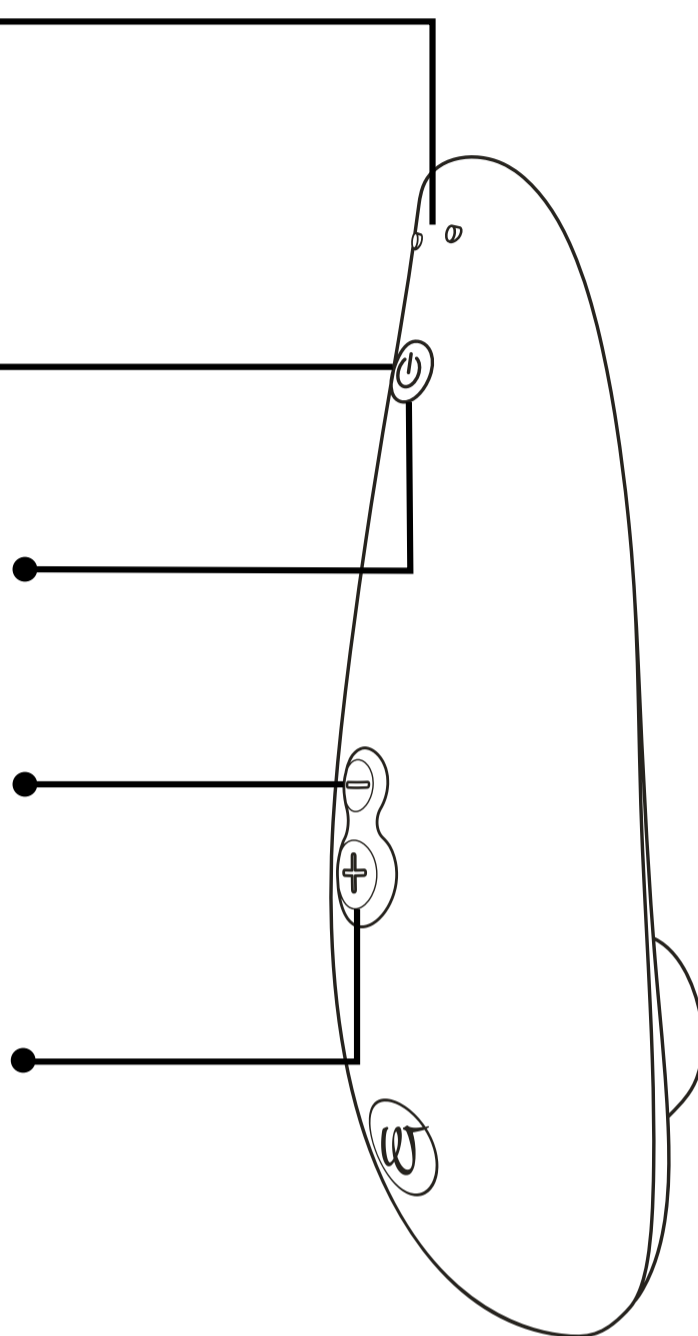

Головка для стимуляции

ИНСТРУКЦИЯ ПО ИСПОЛЬЗОВАНИЮ

1. Включение

Удерживай
кнопку
нажатой
в течение 2
секунд

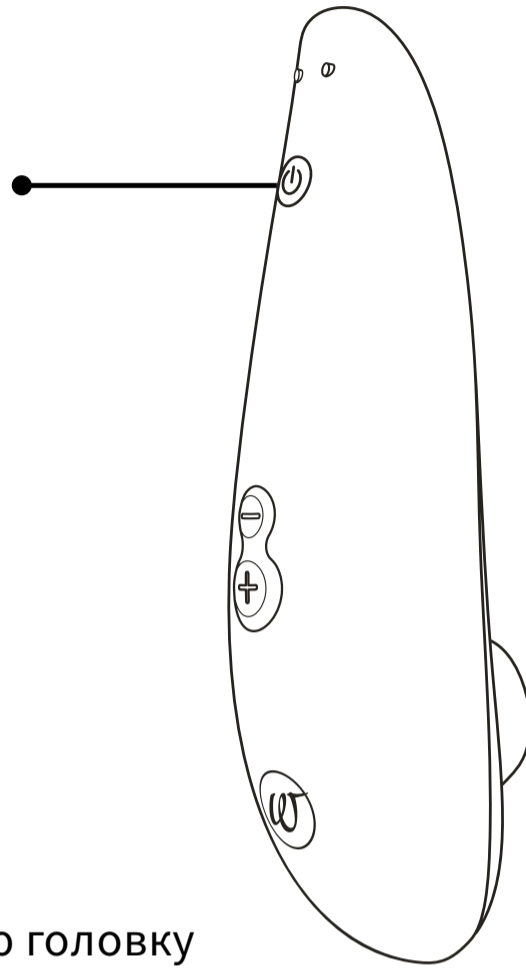

2. Способ использования

Направьте стимулирующую головку
на клитор и начинайте чувственное
путешествие.

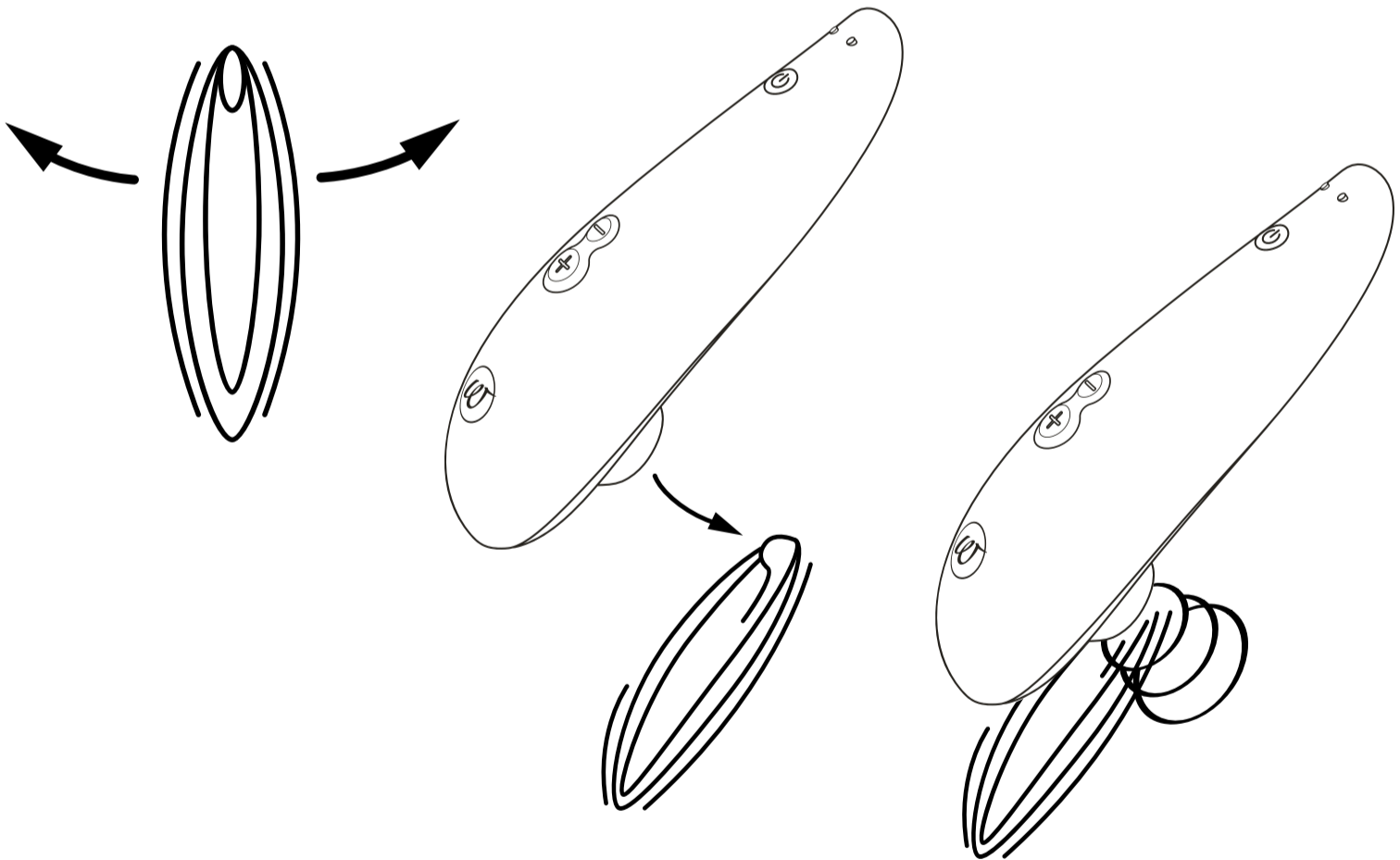

Совет:

Выбери одну из двух входящих в комплект насадок для стимуляции (размер S или M), чтобы подобрать оптимальный уровень комфорта.

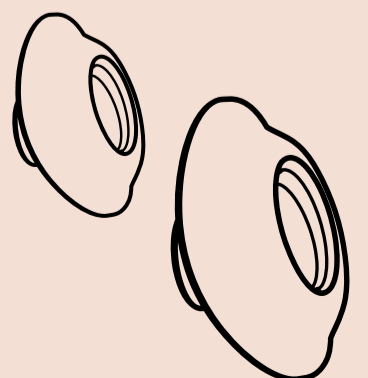

3. Регулировка интенсивности

**Уменьшение
интенсивности**
Коротко нажми на
кнопку

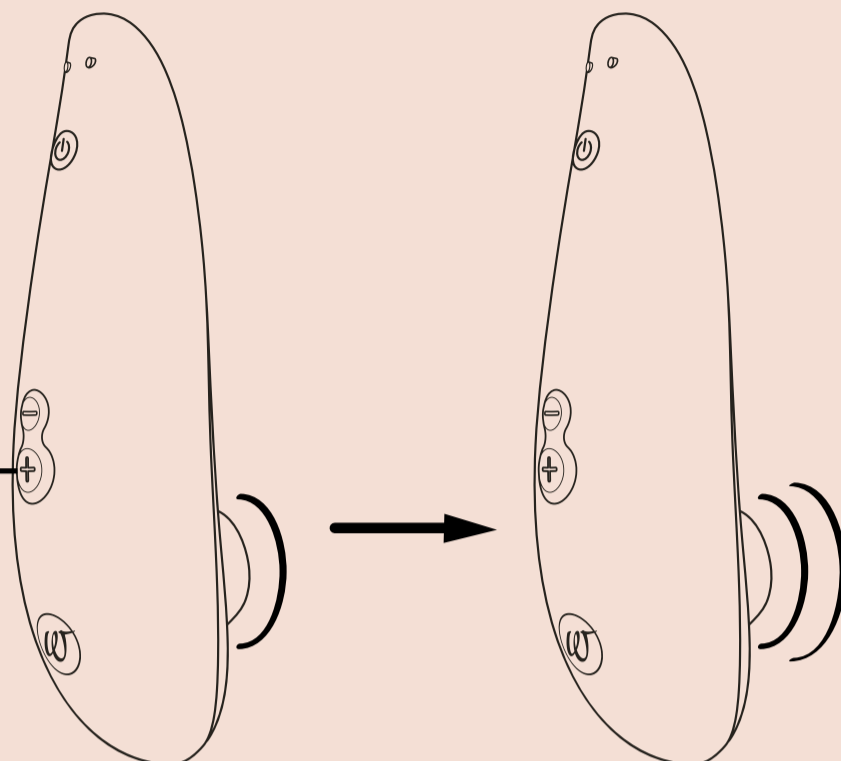

10  **Уровни
интенсивности**

**Увеличение
интенсивности**
Коротко нажми на
кнопку

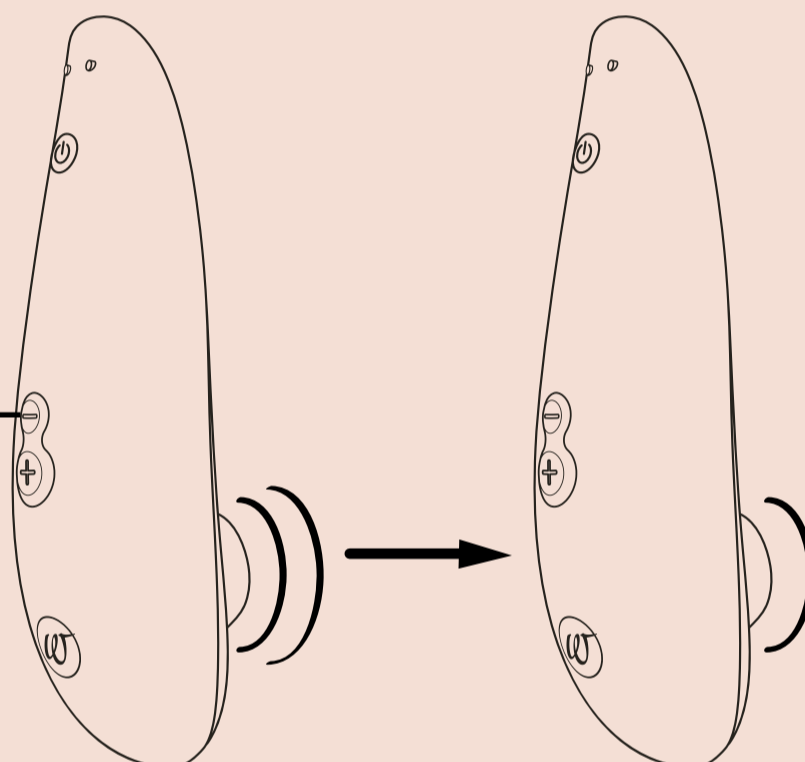

4. Функция Afterglow: коротки нажми кнопку питания, чтобы вернуться к уровню интенсивности 1.

4. Вкл./выкл.

Удерживай
кнопку нажатой
**в течение 2
секунд**

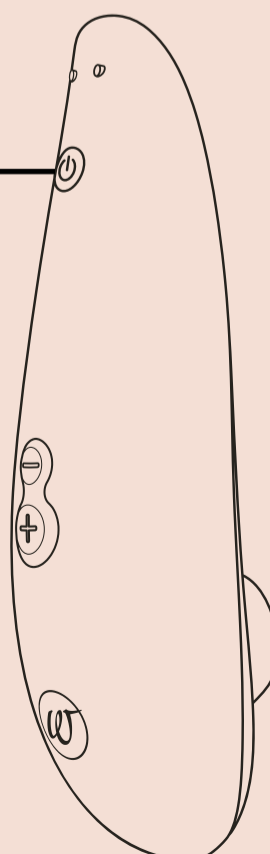

ЗАРЯДКА

Полностью заряди устройство перед первым использованием. Чтобы гарантировать длительное время работы, необходимо регулярно заряжать Womanizer.

Зарядка с помощью USB

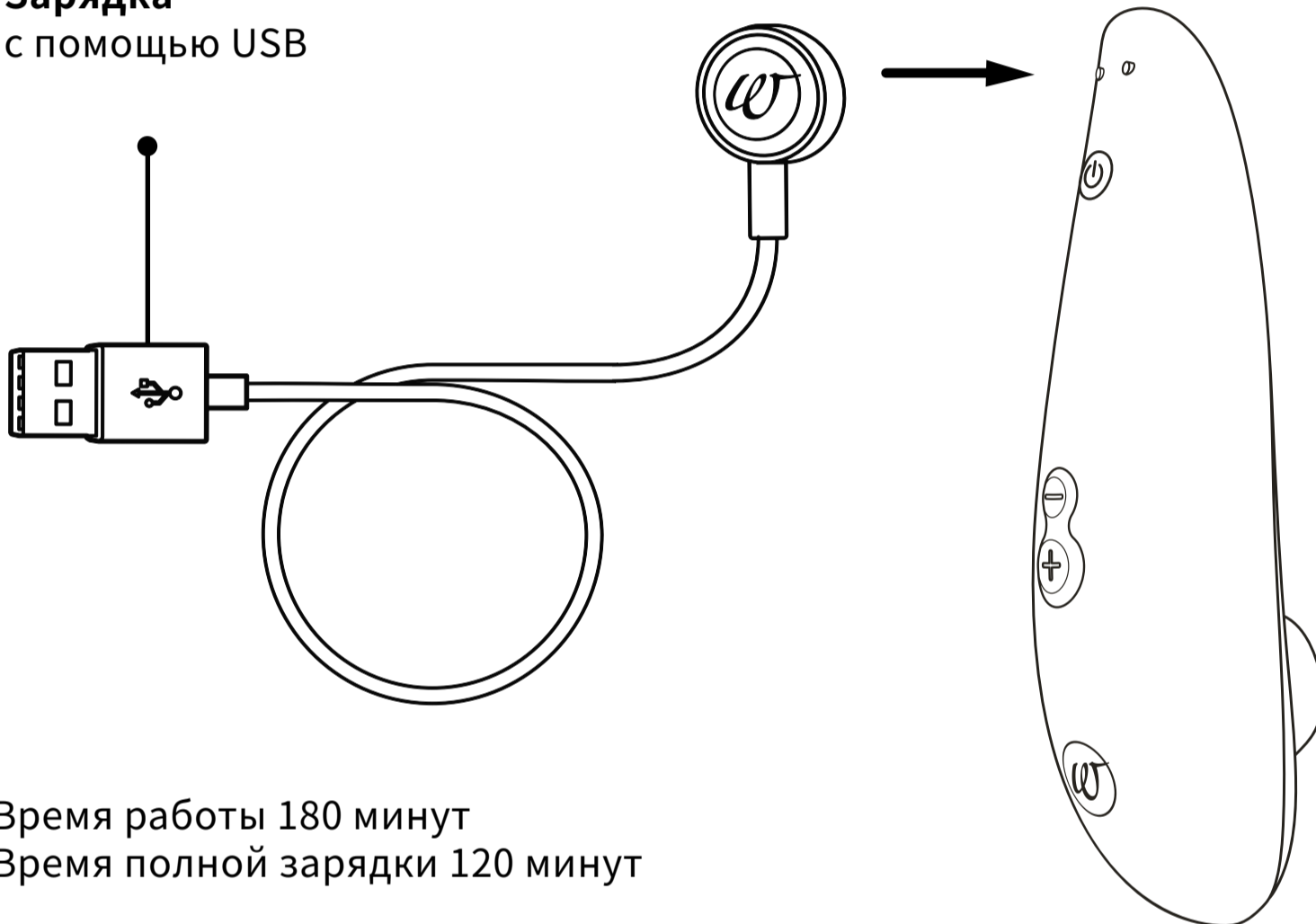

Время работы 180 минут
Время полной зарядки 120 минут

Светодиодная кнопка питания

Уровень зарядки

Устройство полностью заряжено

Светодиод горит непрерывно

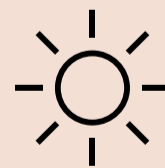

Устройство заряжено наполовину

Светодиод быстро мигает

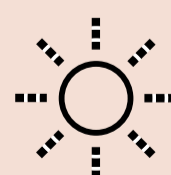

Устройство почти разряжено

Светодиод мигает медленно

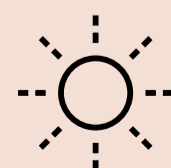

ОЧИСТКА

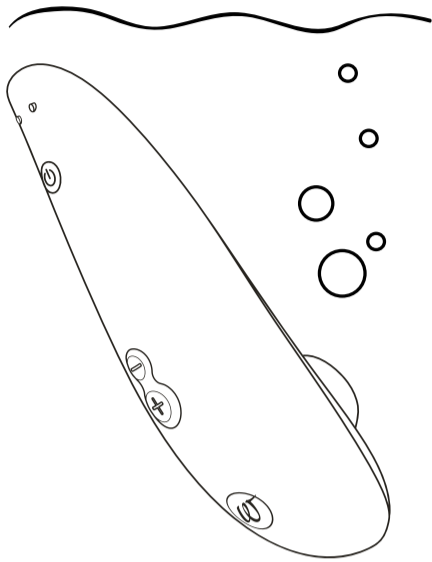

Помой изделие
водой



Нанеси средство для
очистки секс-игрушек

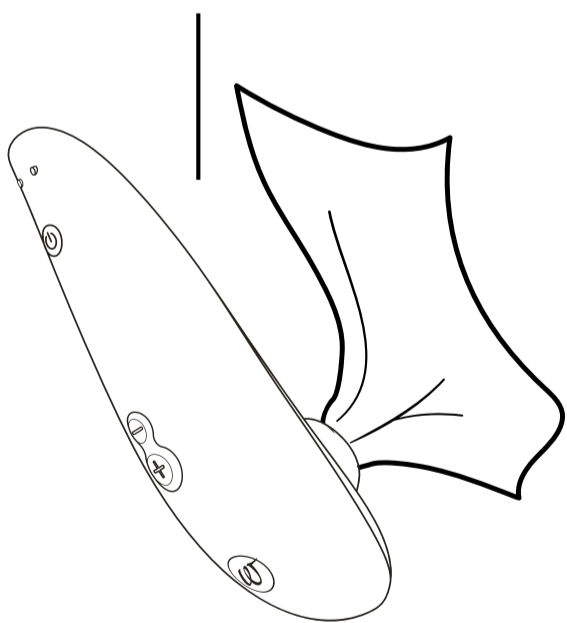

Вытри насухо

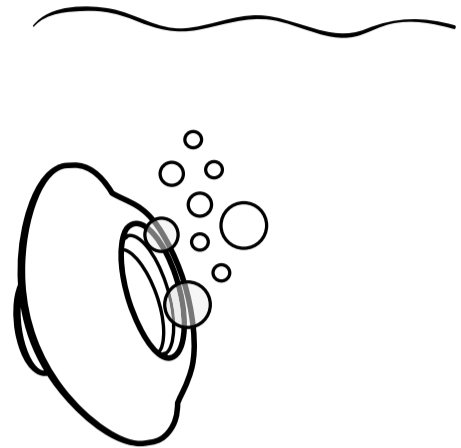

Помой изделие
водой

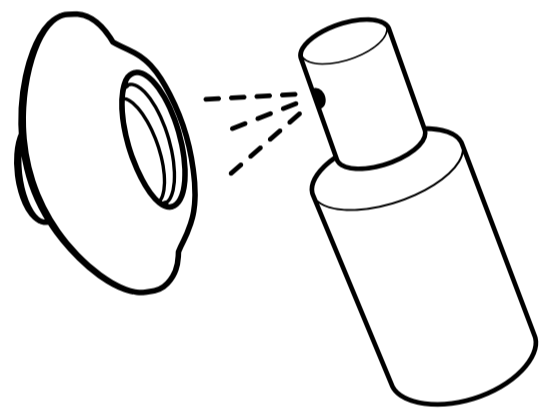

Нанеси средство для
очистки секс-игрушек

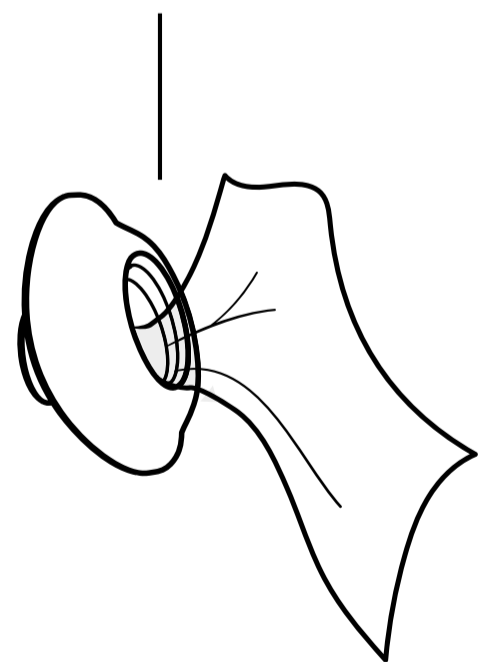

Вытри насухо



Waterproof
IPX7

ОБЩАЯ ИНФОРМАЦИЯ

ПРЕДУПРЕЖДЕНИЕ

Пожалуйста, внимательно прочитай инструкцию по технике безопасности для получения дополнительной информации.

Тщательно очисти Womanizer перед первым использованием, а также очищай его после каждого использования, чтобы снизить риск заражения.

СЕРВИСНАЯ СЛУЖБА

Подробная информация представлена на сайте www.womanizer.com или по запросу на адрес электронной почты care@womanizer.com.

ТЕХНИЧЕСКИЕ ХАРАКТЕРИСТИКИ

Модель: WZ08B

Номинальная мощность: 100-240 В ~ 50/60 Гц

Мощность: 5 В = 0.75 А

Содержит литий-ионную аккумуляторную батарею.

Адаптер переменного/постоянного тока не входит в комплект.

В КОМПЛЕКТ ВХОДИТ

Womanizer Classic 2, USB-кабель для зарядки, хлопчатобумажный мешочек для хранения, 2 две головки для стимуляции, краткое руководство пользователя, инструкция по технике безопасности.

ХРАНЕНИЕ

Храни изделие в надежном, сухом месте, избегая воздействия прямых солнечных лучей.

ГАРАНТИЙНЫЕ ОБЯЗАТЕЛЬСТВА И ДОБРОВОЛЬНАЯ ГАРАНТИЯ ПРОИЗВОДИТЕЛЯ

В дополнение к законодательно предусмотренной гарантии компания WOW TECH EUROPE GMBH предлагает клиентам добровольную гарантию производителя на данное изделие. Условия добровольной гарантии производителя приведены на нашем сайте в разделе «Гарантийные условия».

СООТВЕТСТВИЕ СТАНДАРТАМ

Данное изделие соответствует всем стандартам электромагнитной совместимости (ЭМС). Изделие безопасно для использования до тех пор, пока оно используется по назначению и в соответствии с инструкциями, приведенными в данном руководстве пользователя.

ЗАЩИТА ОКРУЖАЮЩЕЙ СРЕДЫ

Как дистрибьютор электронных устройств, мы по закону обязаны принимать отработавшие электрические и электронные устройства бесплатно. По закону пользователи обязаны вернуть отработавшие аккумуляторные батареи. Никогда не выбрасывай электронные устройства или батарейки в бытовые отходы. Символ, изображенный ниже, нанесен на наши электронные изделия с целью напомнить об этом.

ПРОИЗВОДИТЕЛЬ

WOW Tech Europe GmbH,
Friedenstrasse 91 / 91 a, 10249 Berlin,
Германия

WOW Tech Europe GmbH оставляет за собой право вносить технические изменения, а также изменения в конструкцию с целью усовершенствования изделия.

В Северной Америке продукция распространяется компанией WOW TECH Canada Ltd. 1545 Carling Avenue, Suite 401, Ottawa, Онтарио, Канада K1Z 8P9

www.wowtech.com Разработано в Германии. Произведено в Китае в 2021. Руководство пользователя вышло 02/2021. Версия 1.

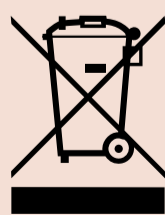

ВСЁ ЕЩЕ ХОЧЕШЬ БОЛЬШЕГО?

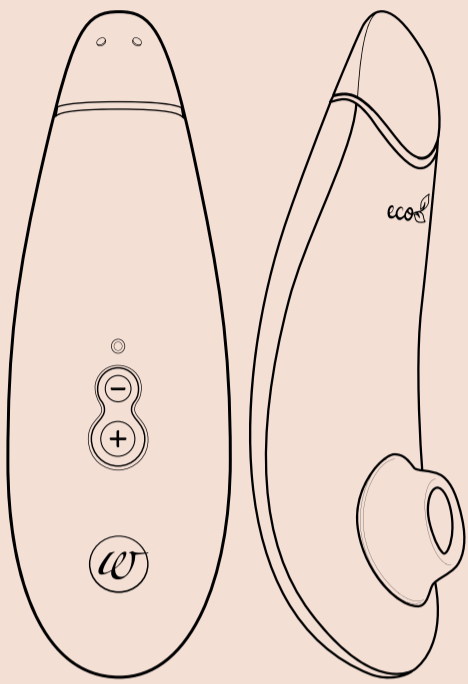

**Pleasure Air
Technology**



Smart Silence



Eco-friendly

Premium eco 

Loving Our Planet Can Be Orgasmic

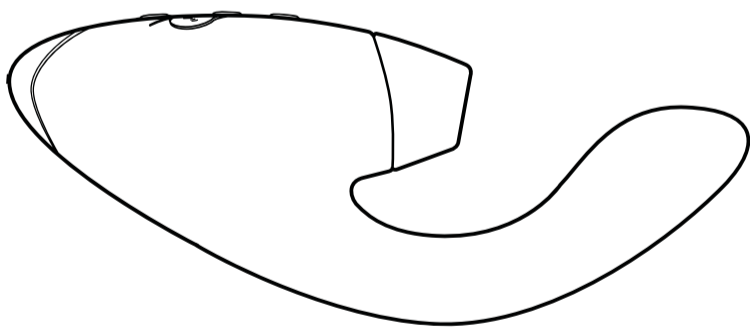

**Pleasure Air
Technology**



Vibrator



Smart Silence

DUO

Double your Pleasure



#IMASTURBATE

Dzień dobry!

Dziękujemy, że wybrałaś Womanizer!

Witaj w świecie pełnym zmysłowych doznań, które wzbogacą Twoje życie. Wybierając WOMANIZER, odkryjesz nie tylko niezrównane orgazmy - lecz także zupełnie nowe pragnienie przyjemności.

Poznaj WOMANIZER - jeden orgazm za drugim.

Pokochaj się!



OPIS PRODUKTU

SPOSÓB UŻYCIA

ŁADOWANIE

CZYSZCZENIE

INFORMACJE OGÓLNE

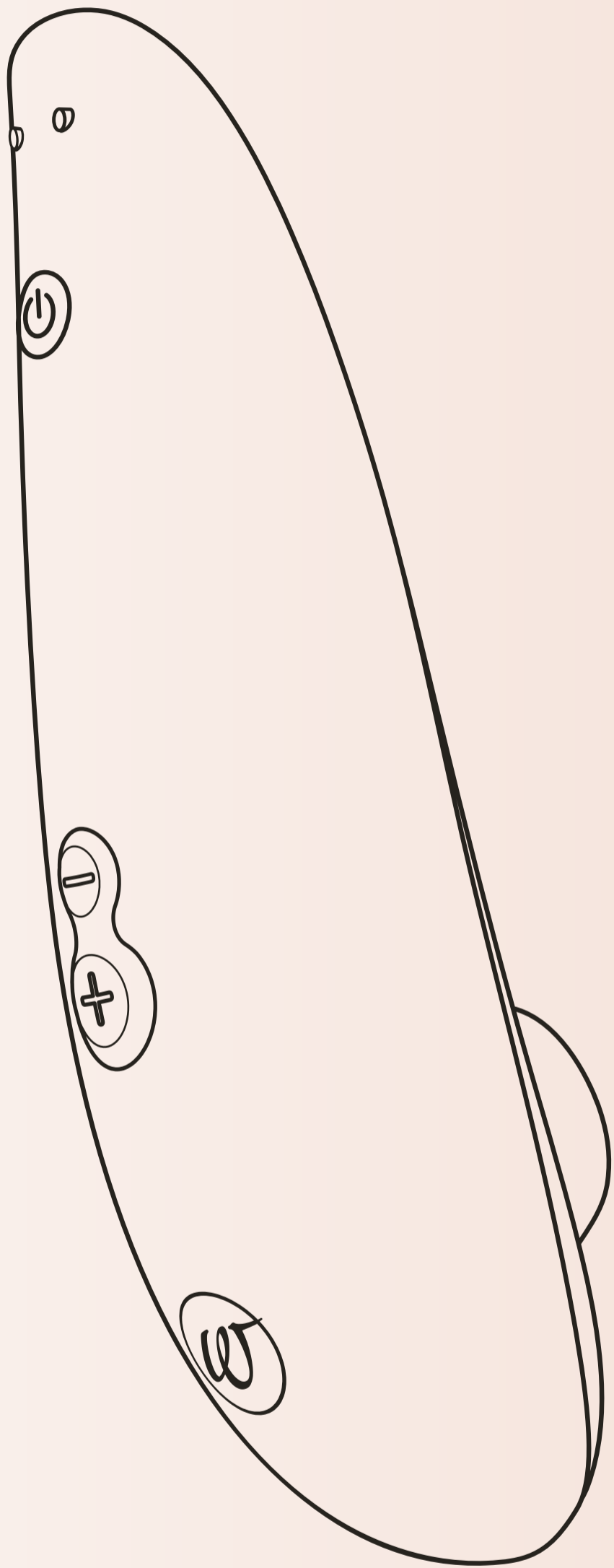

OPIS PRODUKTU

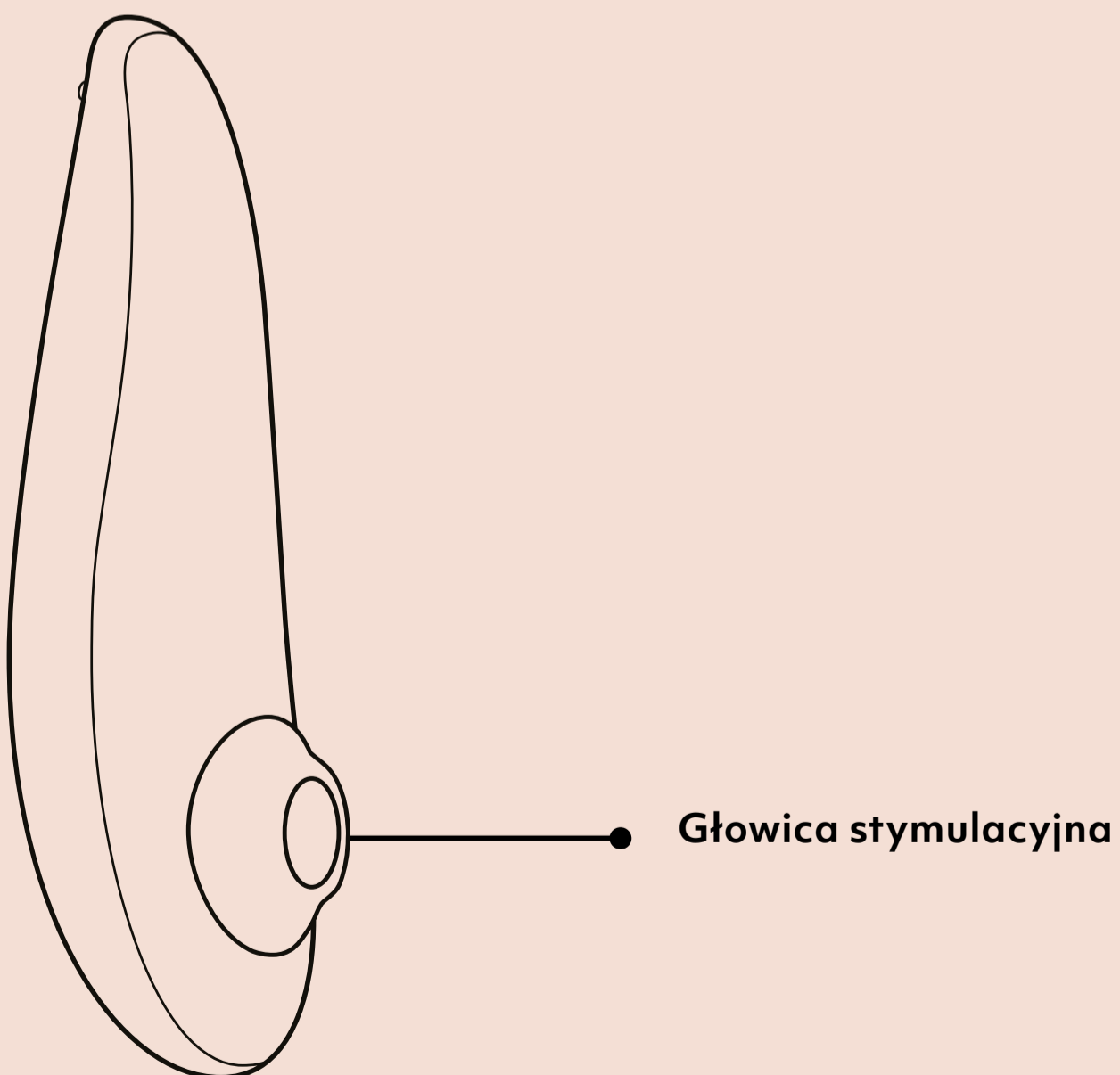
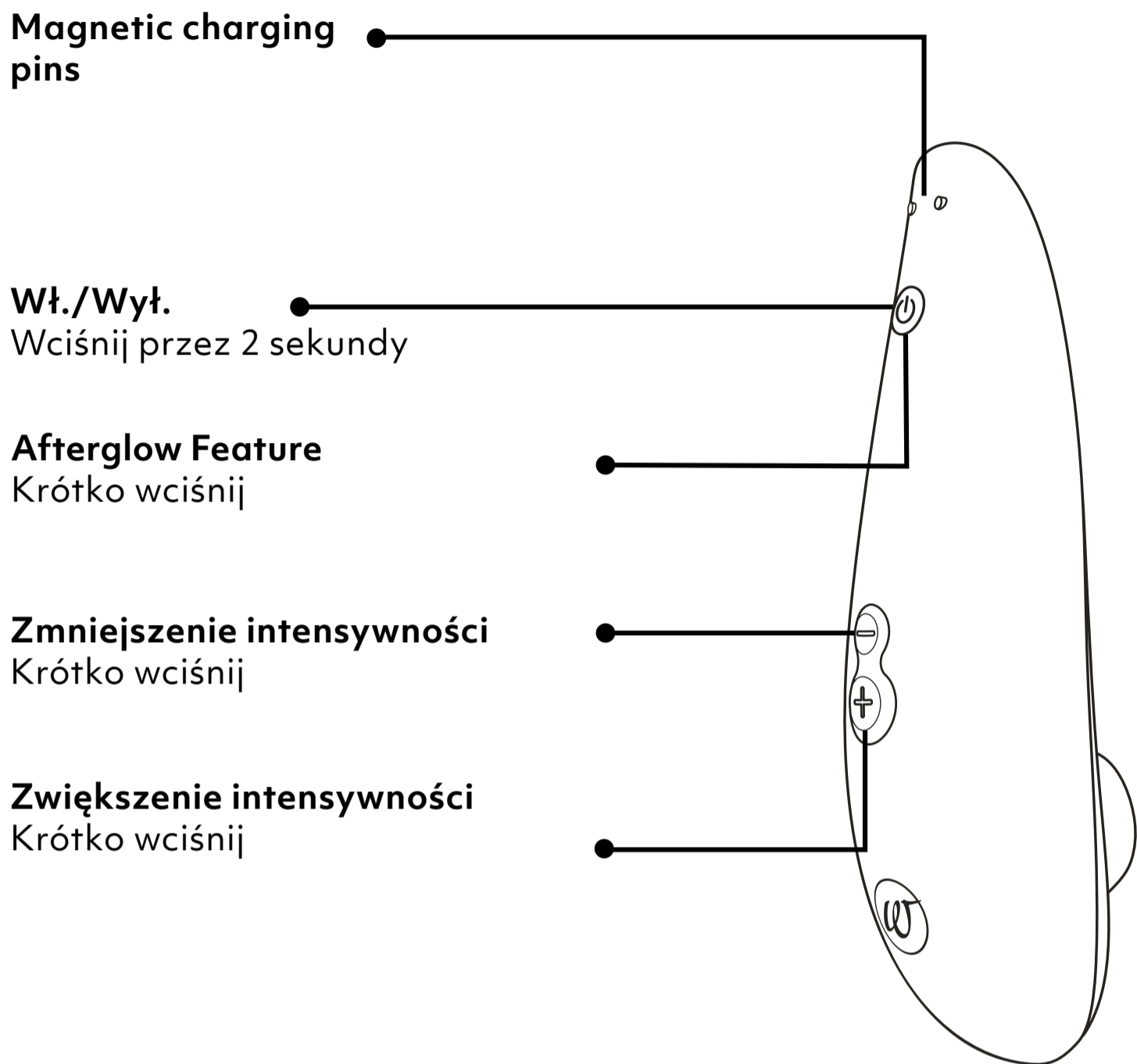

SPOSÓB UŻYCIA

1. Włącz

Pulsa
durante
2 segundos

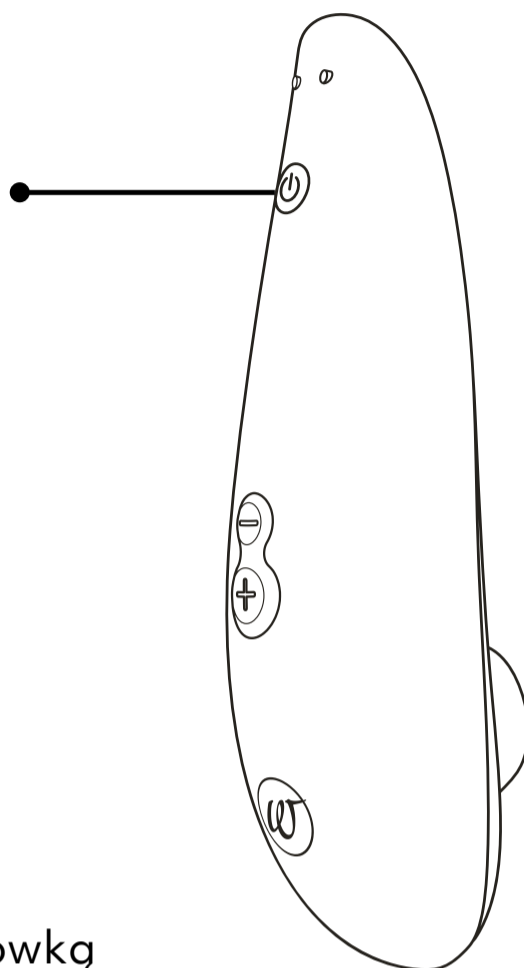

2. Użycie

Otocz swoją łechtaczkę główką stymulującą i Twoja podróż się zaczyna.

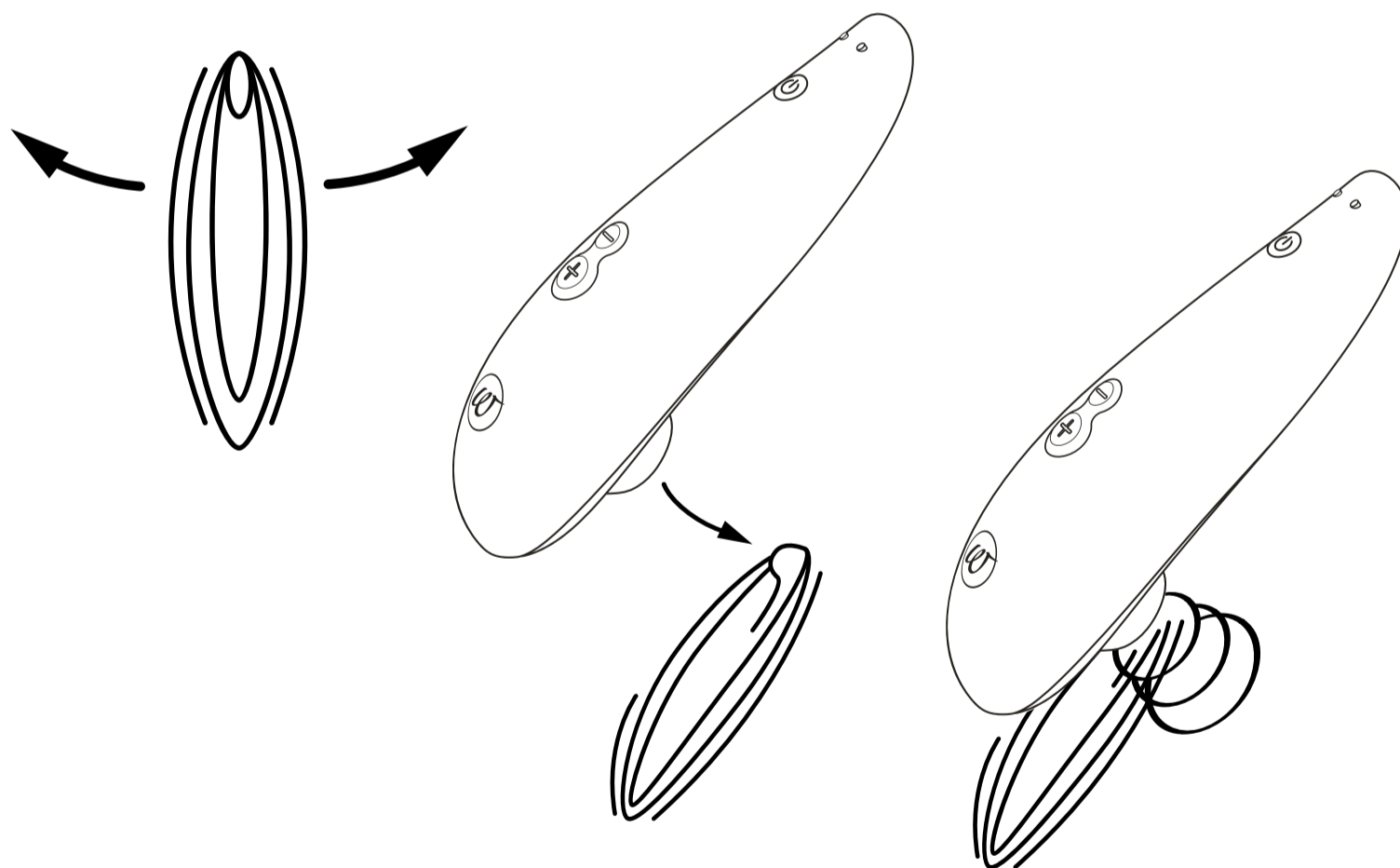

Mała wskazówka:

Jeśli zauważysz, że główka stymulująca nie jest jeszcze optymalnie dopasowana, zmieniaj główki dołączone do urządzenia (S lub M) i wybierz tę, która daje Ci najlepsze doznania.

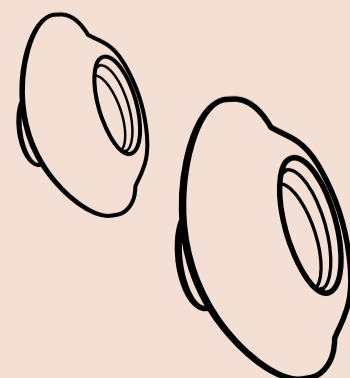

3. Zmiana intensywności

Zwiększ
Krótco wciśnij

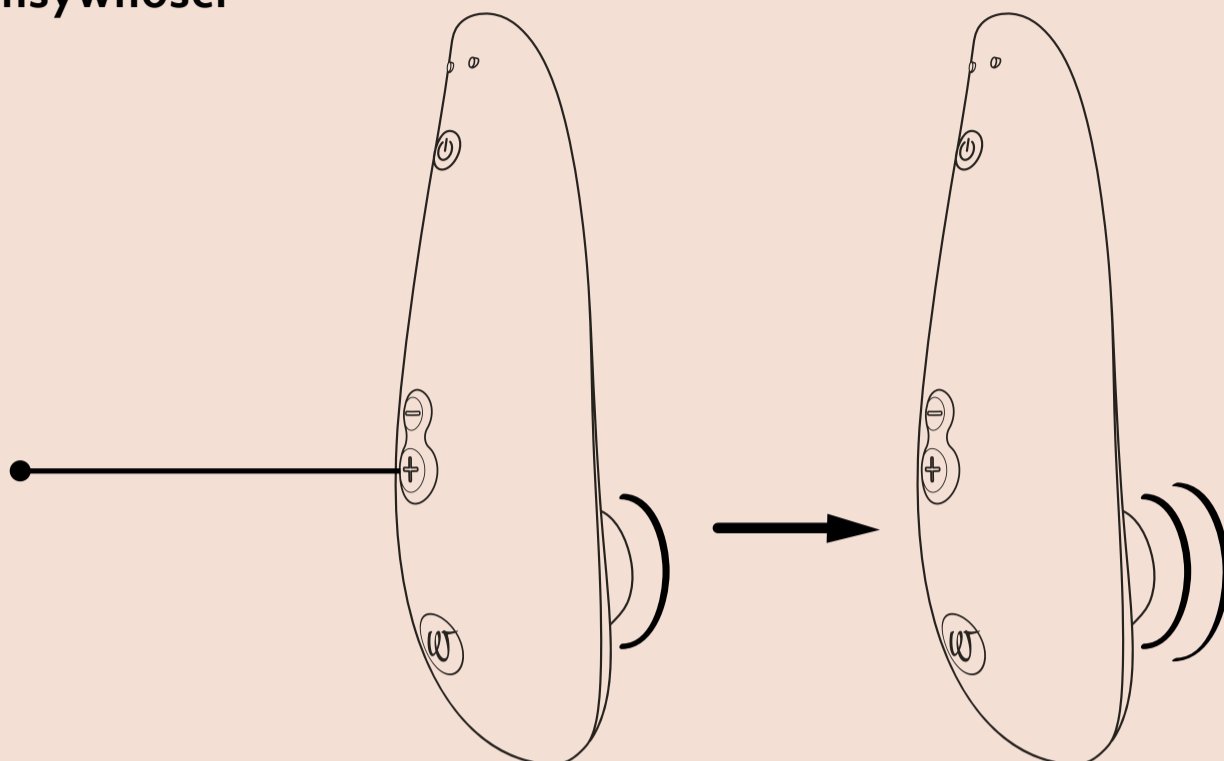

10  **Poziomy**
intensywności

Zmniejsz
Krótco wciśnij

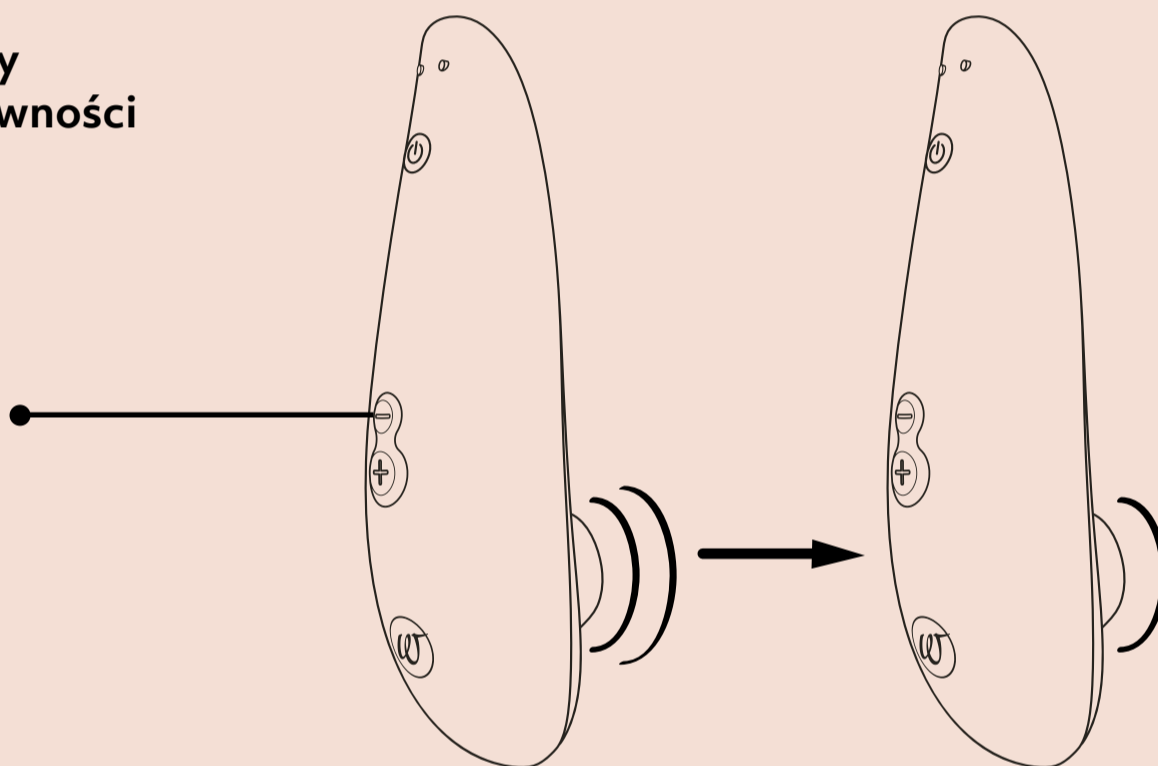

Afterglow Feature:: Krótco wciśnij przycisk zasilania, aby powrócić do 1. poziomu intensywności.

4. Wyłącz

Wciśnij przez
2 sekundy

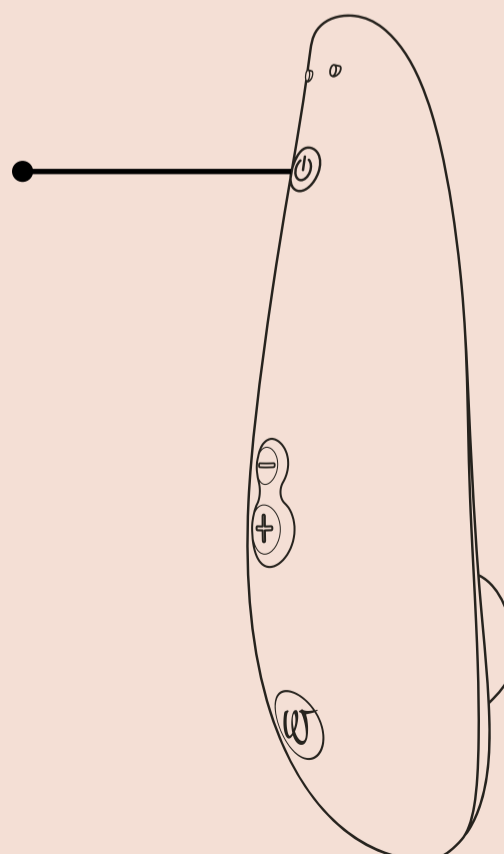

ŁADOWANIE

Przed pierwszym użyciem całkowicie naładuj Womanizer.
Pamiętaj również, aby regularnie ładować swój Womanizer, co zapewni długą żywotność akumulatora.

Ładowanie przez port USB

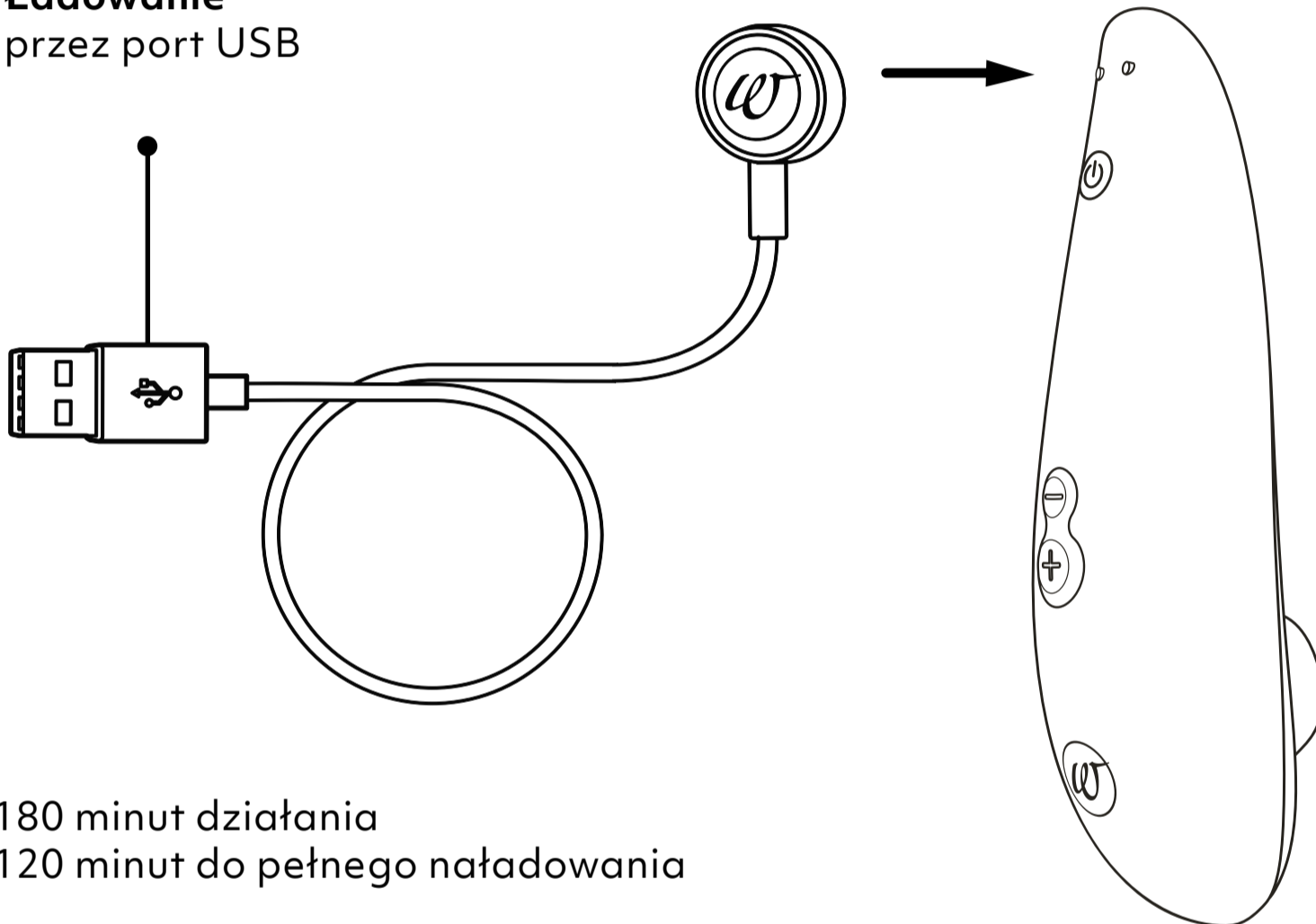

180 minut działania
120 minut do pełnego naładowania

Przycisk zasilania LED

Poziom naładowania

Całkowicie naładowany

Dioda LED świeci ciągle

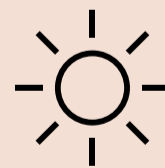

Częściowo naładowany

Dioda LED miga szybko

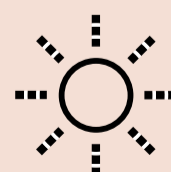

Prawie rozładowany

Dioda LED miga powoli

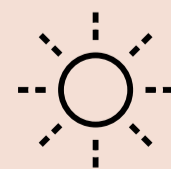

CZYSZCZENIE

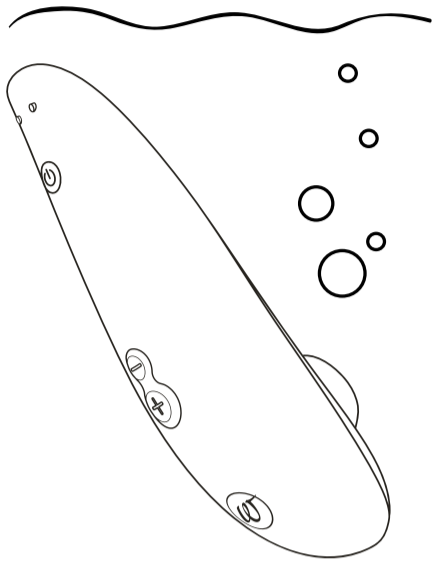

Umyj wodą

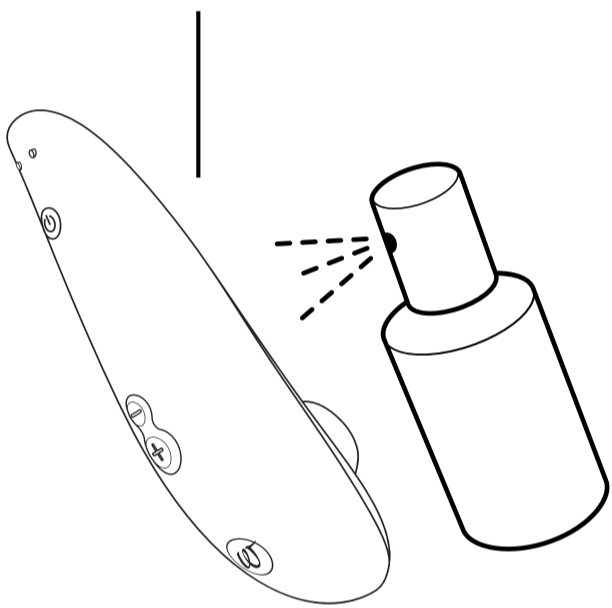

Używaj produktu do mycia zabawek

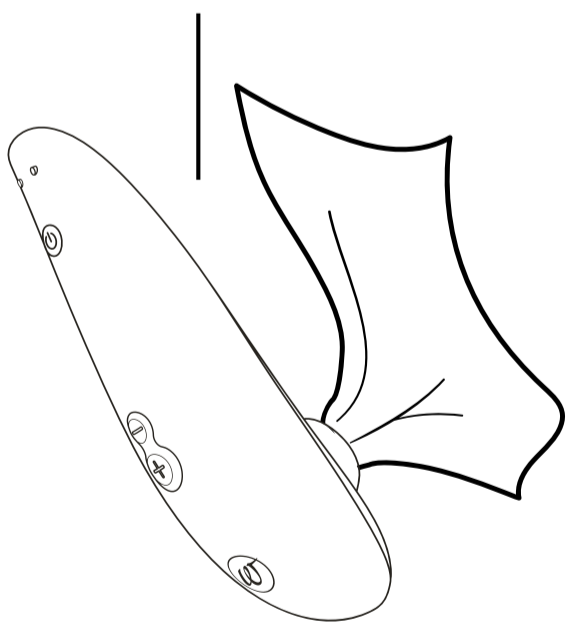

Osusz

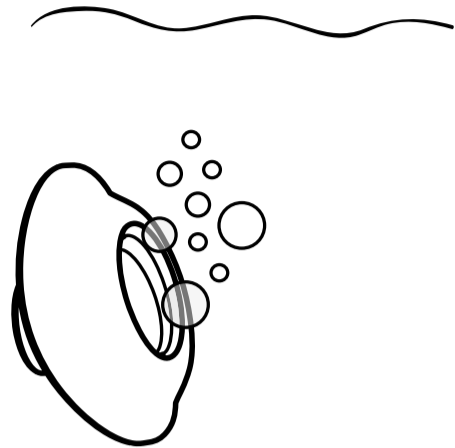

Umyj wodą

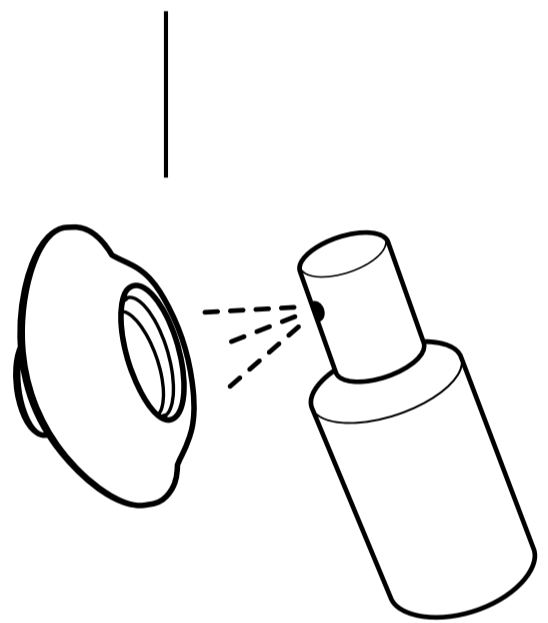

Używaj produktu do mycia zabawek

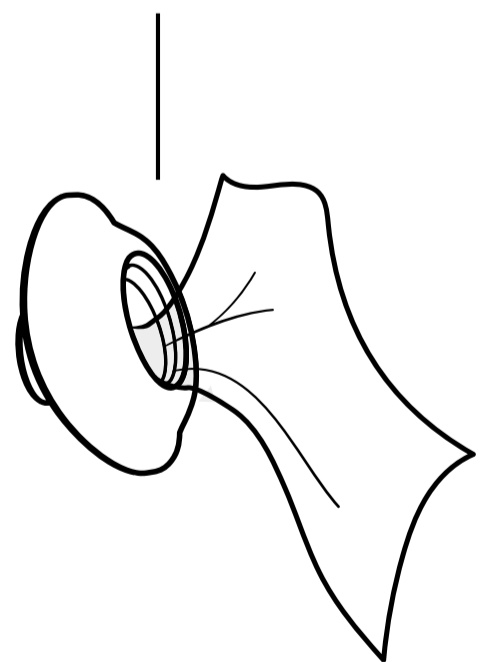

Osusz



Waterproof
IPX7

INFORMACJE OGÓLNE

OSTRZEŻENIE

Uważnie zapoznaj się z instrukcją bezpieczeństwa, aby uzyskać dalsze informacje.

Przed pierwszym użyciem oraz po każdym kolejnym użyciu dokładnie umyj Womanizer, aby ograniczyć ryzyko infekcji.

OBSŁUGA KLIENTA

Szczegółowe informacje znajdują się na naszej stronie www.womanizer.com, można również skontaktować się z nami pod adresem care@womanizer.com.

SPECYFIKACJA TECHNICZNA

Model: WZ08B

Parametry elektryczne: 100-240 V ~ 50/60 Hz

Moc wyjściowa: 5 V $\overline{=}$ 0.75 A

Zawiera akumulator litowo-jonowy.

Zasilacz AC/DC nie jest częścią zestawu.

SKŁADNIKI ZESTAWU

Womanizer Classic 2, przewód USB do ładowania, bawełniany woreczek, 2 główki stymulujące, skrócona instrukcja obsługi, instrukcja bezpieczeństwa.

PRZECHOWYWANIE

Urządzenie przechowuj w zabezpieczonym, suchym miejscu, nie narażonym na bezpośrednie nasłonecznienie.

GWARANCJA ORAZ DODATKOWA GWARANCJA PRODUCENTA

Oprócz standardowej ustawowej gwarancji, WOW TECH EUROPE GMBH udziela na ten produkt dodatkowej, dobrowolnej gwarancji producenta. Warunki dodatkowej gwarancji producenta są zamieszczone w naszej witrynie internetowej w sekcji „Warunki gwarancji”.

ZGODNOŚĆ Z NORMAMI

Niniejsze urządzenie jest zgodne z wszelkimi normami w zakresie kompatybilności elektromagnetycznej (EMC). Urządzenie jest bezpieczne w użyciu pod warunkiem, że jest stosowa-

wane w sposób poprawny, zgodnie z instrukcją obsługi.

OCHRONA ŚRODOWISKA

Jako dystrybutor urządzeń elektronicznych, jesteśmy prawnie zobowiązani do bezpłatnego przyjęcia zwrotu zużytego sprzętu elektrycznego i elektronicznego. Podkreślamy, że jako użytkownik masz prawny obowiązek zwrotu zużytych baterii/akumulatorów. Nigdy nie wyrzucaj urządzeń elektronicznych ani baterii/akumulatorów do odpadów komunalnych.

Poniższy symbol, który znajduje się również na naszych urządzeniach elektronicznych, ma na celu wyraźne przypomnienie o tym zakazie.

PRODUCENT

WOW Tech Europe GmbH,
Friedenstrasse 91 / 91 a, 10249 Berlin, Niemcy

WOW Tech Europe GmbH zastrzega sobie prawo do wprowadzenia zmian technicznych oraz w projekcie urządzenia, które mają na celu jego udoskonalenie.

Dystrybutor w Ameryce Północnej:
WOW TECH Canada Ltd. 1545 Carling Avenue, Suite 401, Ottawa ON, Canada K1Z 8P9

www.wowtech.com Zaprojektowano w Niemczech. Wyprodukowano w Chinach w 2021 r. Data wydania instrukcji: 02/2021. Wersja 1.

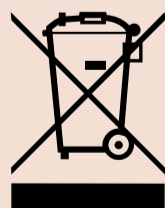

WCIAŻ PRAGNIESZ WIĘCEJ?

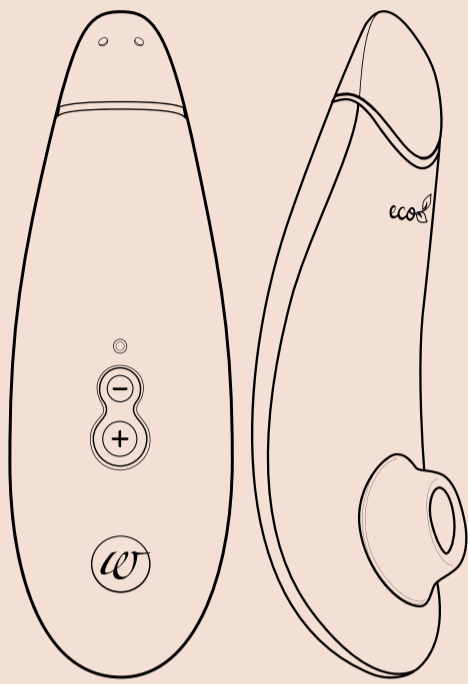

**Pleasure Air
Technology**



Smart Silence



Eco-friendly

Premium eco 

Loving Our Planet Can Be Orgasmic

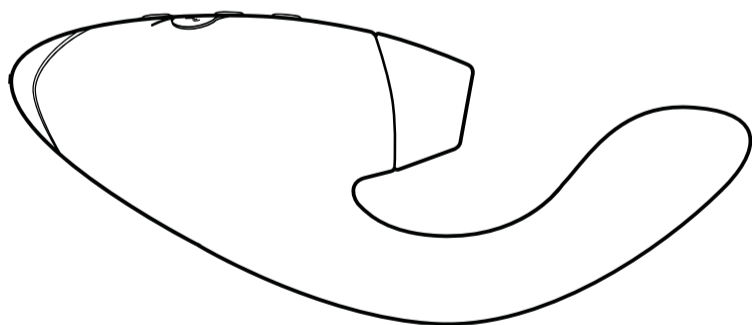

**Pleasure Air
Technology**



Vibrator



Smart Silence

DUO

Double your Pleasure



#IMASTURBATE

Hej!

Tack för att du valde Womanizer!

Välkommen till en värld av sensuella upplevelser som kommer att berika ditt liv. Genom att välja WOMANIZER garanteras du inte bara ojämförbara orgasmer – utan även en helt ny lust till njutning.

Njut av din WOMANIZER – en orgasm i taget.

Älska dig själv!



PRODUKT BESKRIVNING

ANVÄNDNING

LADDNING

RENGÖRING

ALLMÄN INFORMATION

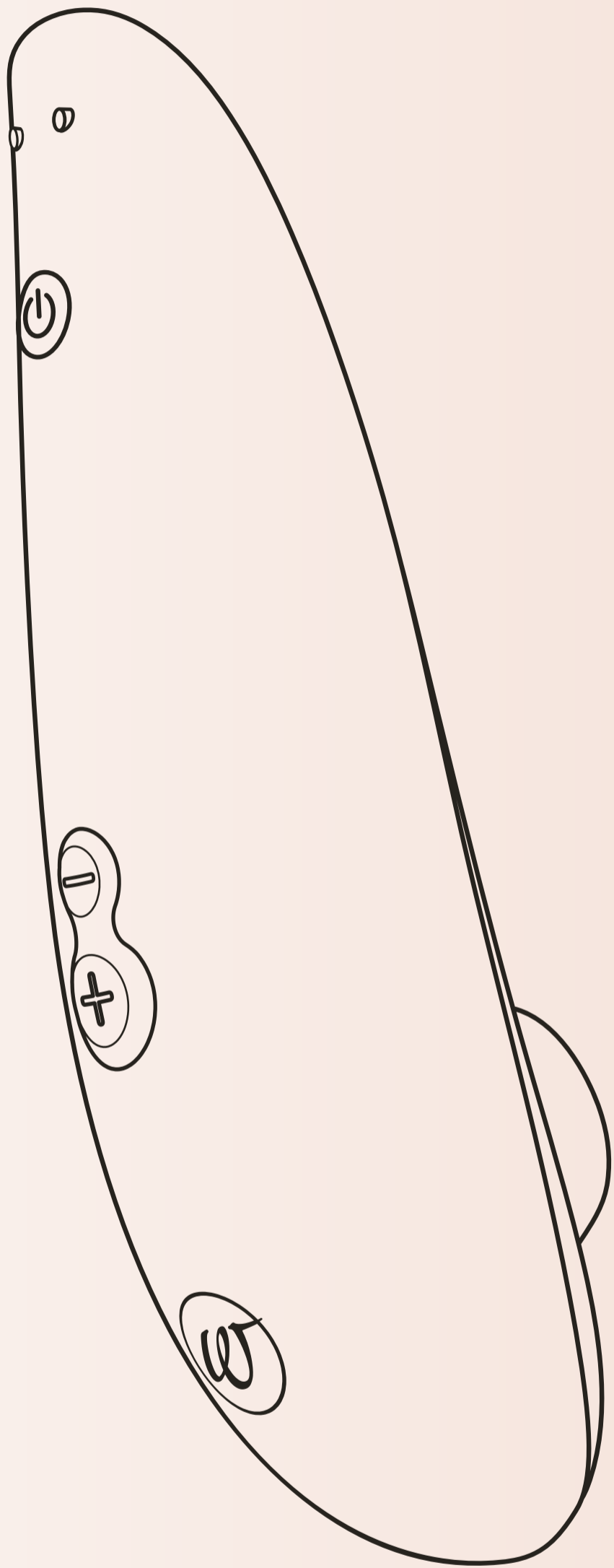

PRODUKTBESKRIVNING

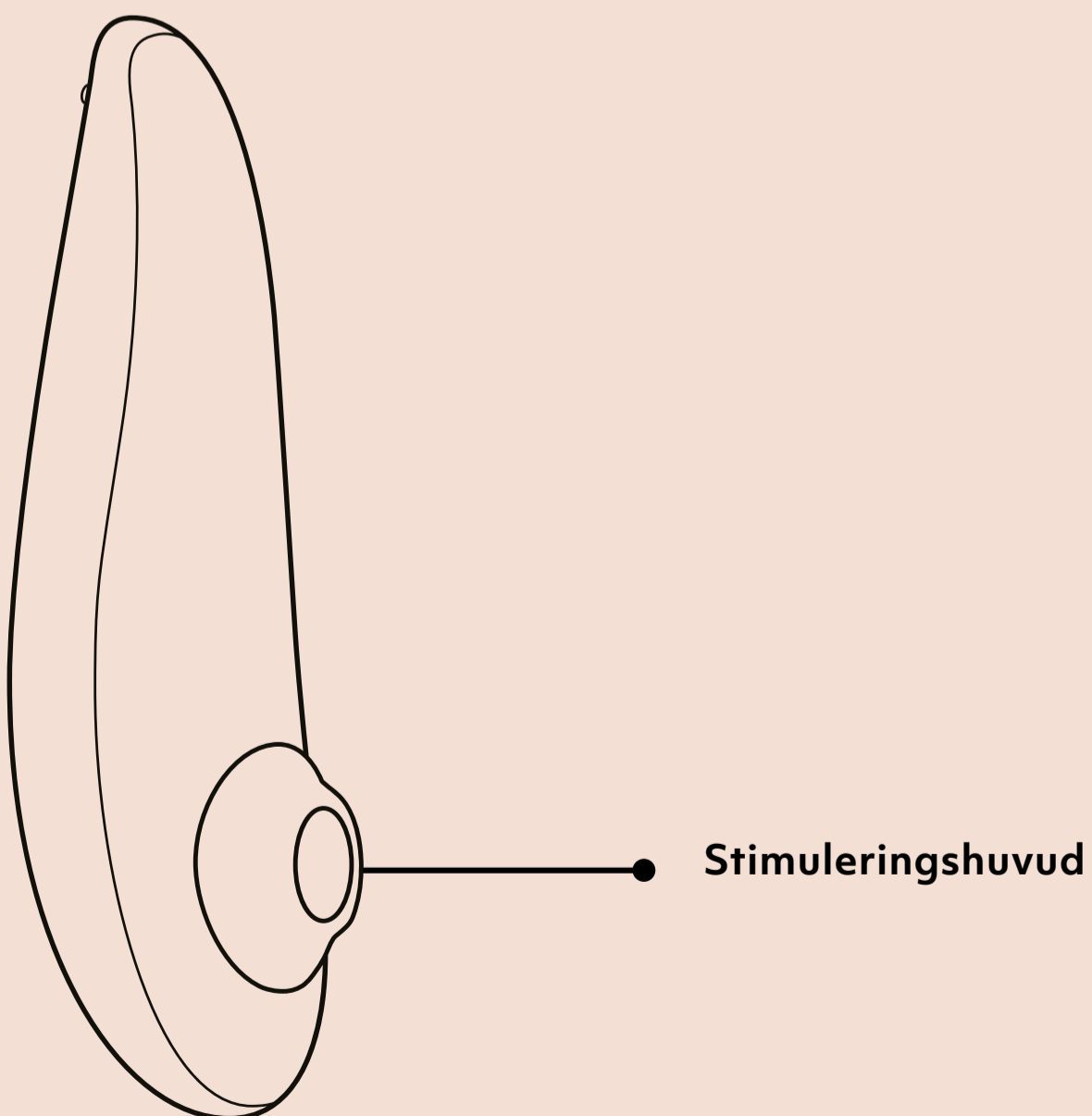
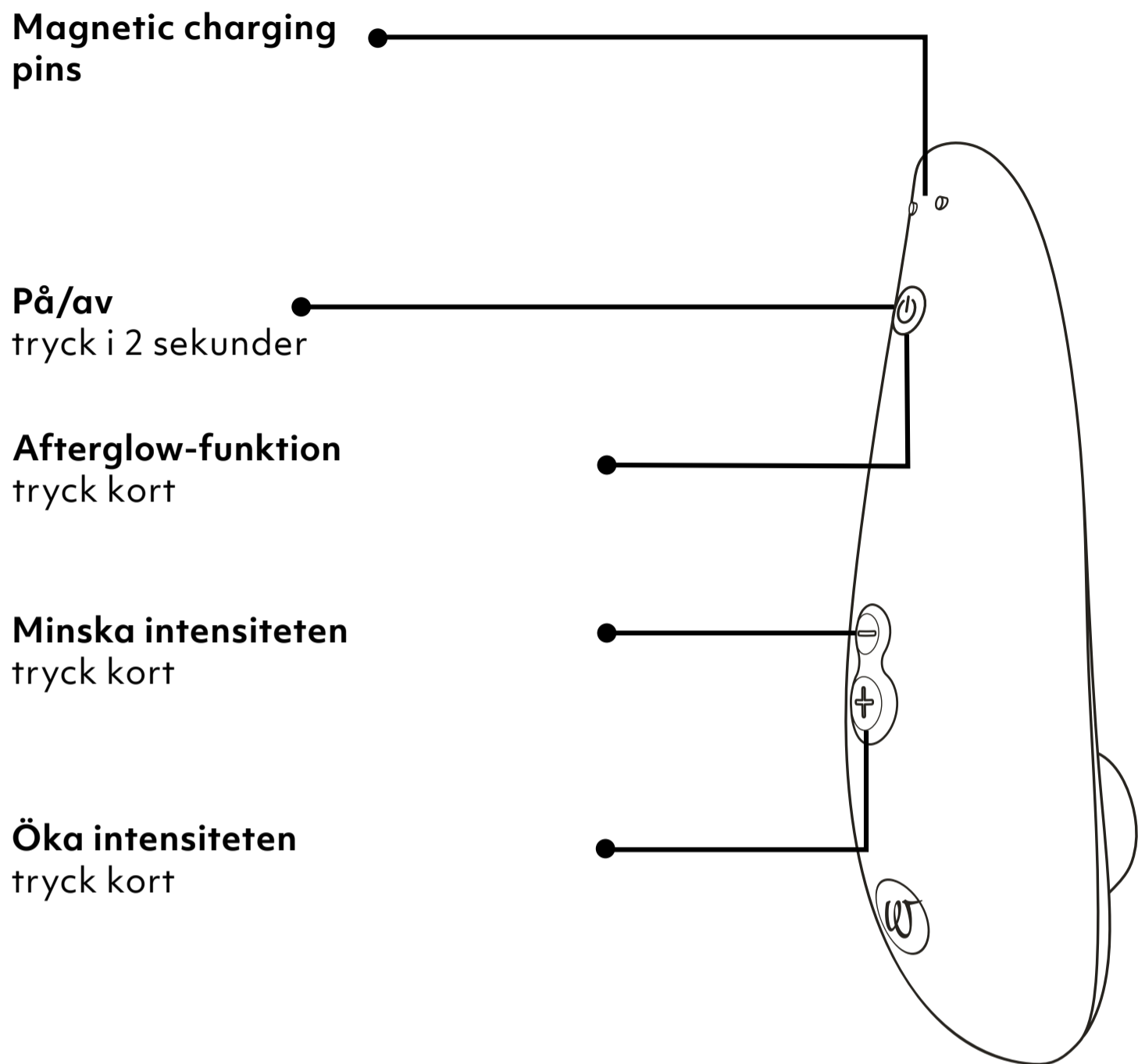

ANVÄNDNING

1. Slå på

Tryck i
2 sekunder

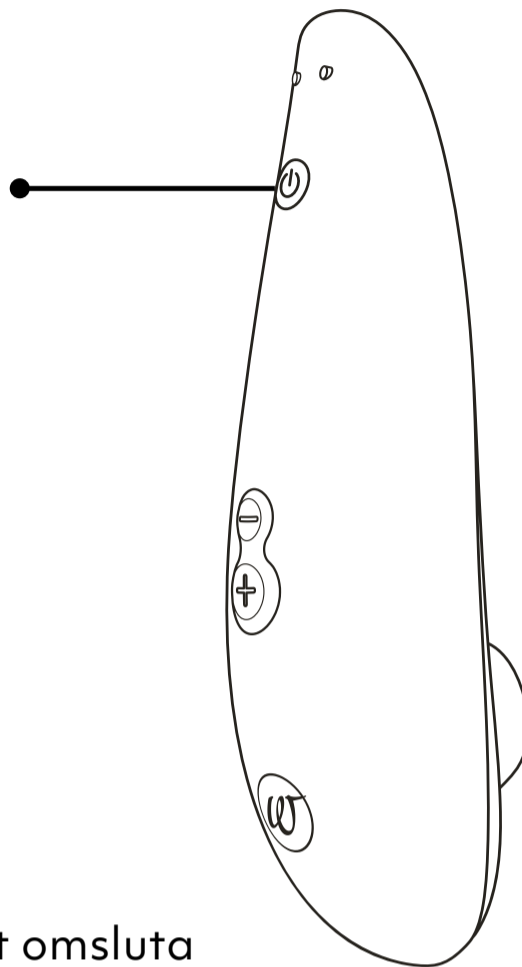

2. Användning

Låt stimuleringsmunstycket omsluta klitoris och påbörja din resa.

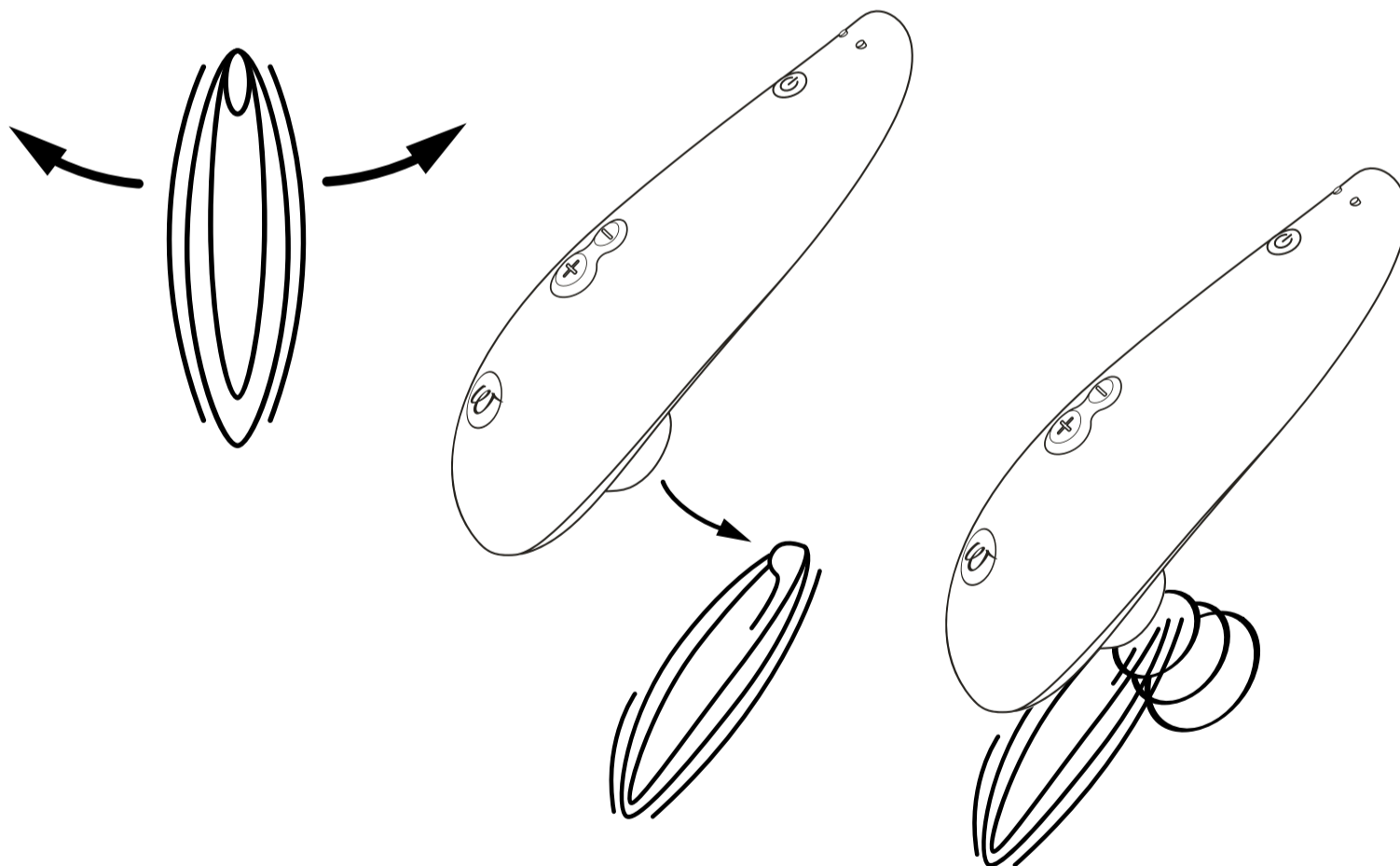

Ett litet tips:

Om du märker att stimuleringsstillbehöret inte har optimal passform kan du växla mellan de två stimuleringsstillbehören (S eller M) som medföljer enheten för att skapa den bästa känslan för dig.

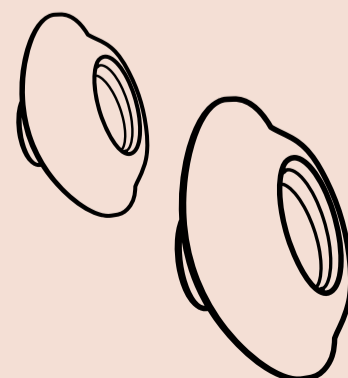

3. Ändra styrka

Öka
tryck kort

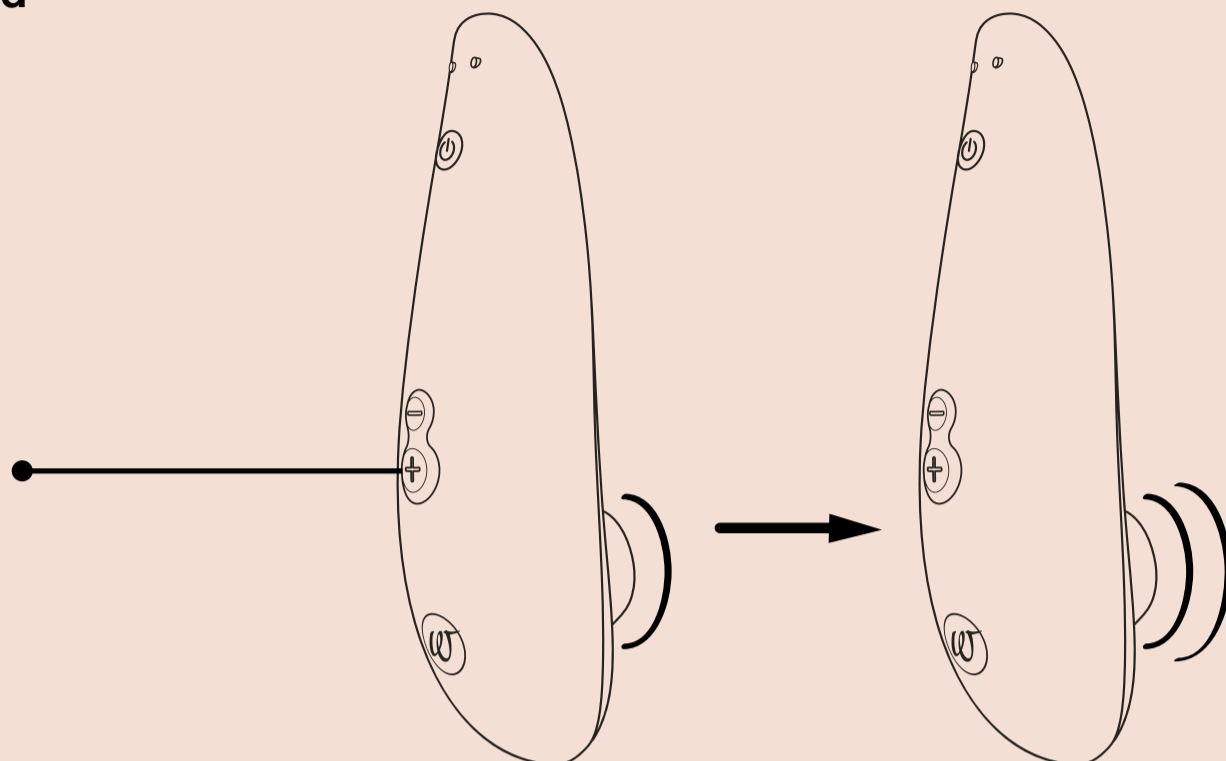

10  Intensitets
nivåer

Minska
tryck kort

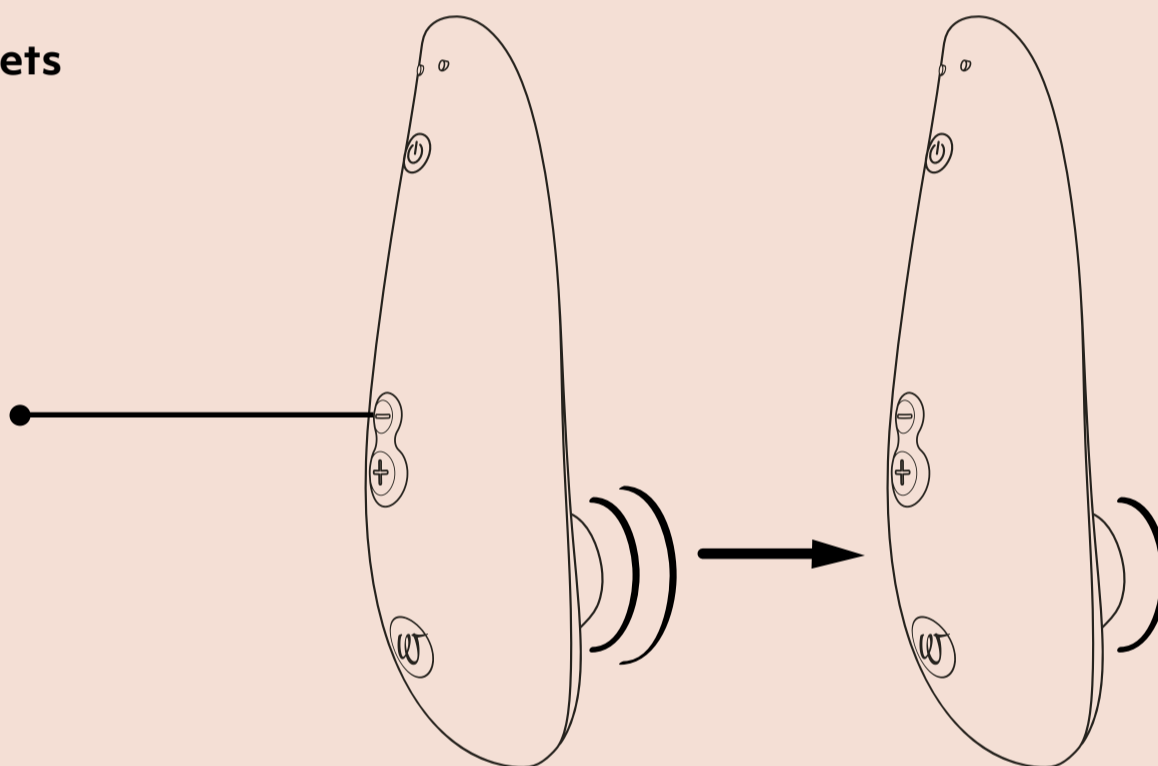

Afterglow-funktion: Tryck kort på strömbrytaren för att återgå till intensitetsnivå 1.

4. Stäng av

tryck i
2 sekunder

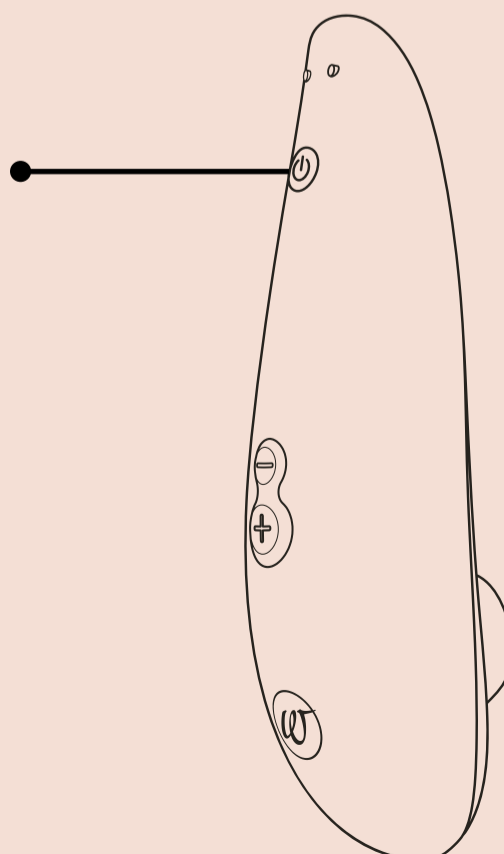

LADDNING

Ladda din Womanizer innan du använder den för första gången. Tänk även på att ladda din Womanizer regelbundet för att säkerställa att batteriet håller länge.

Laddning via USB-port

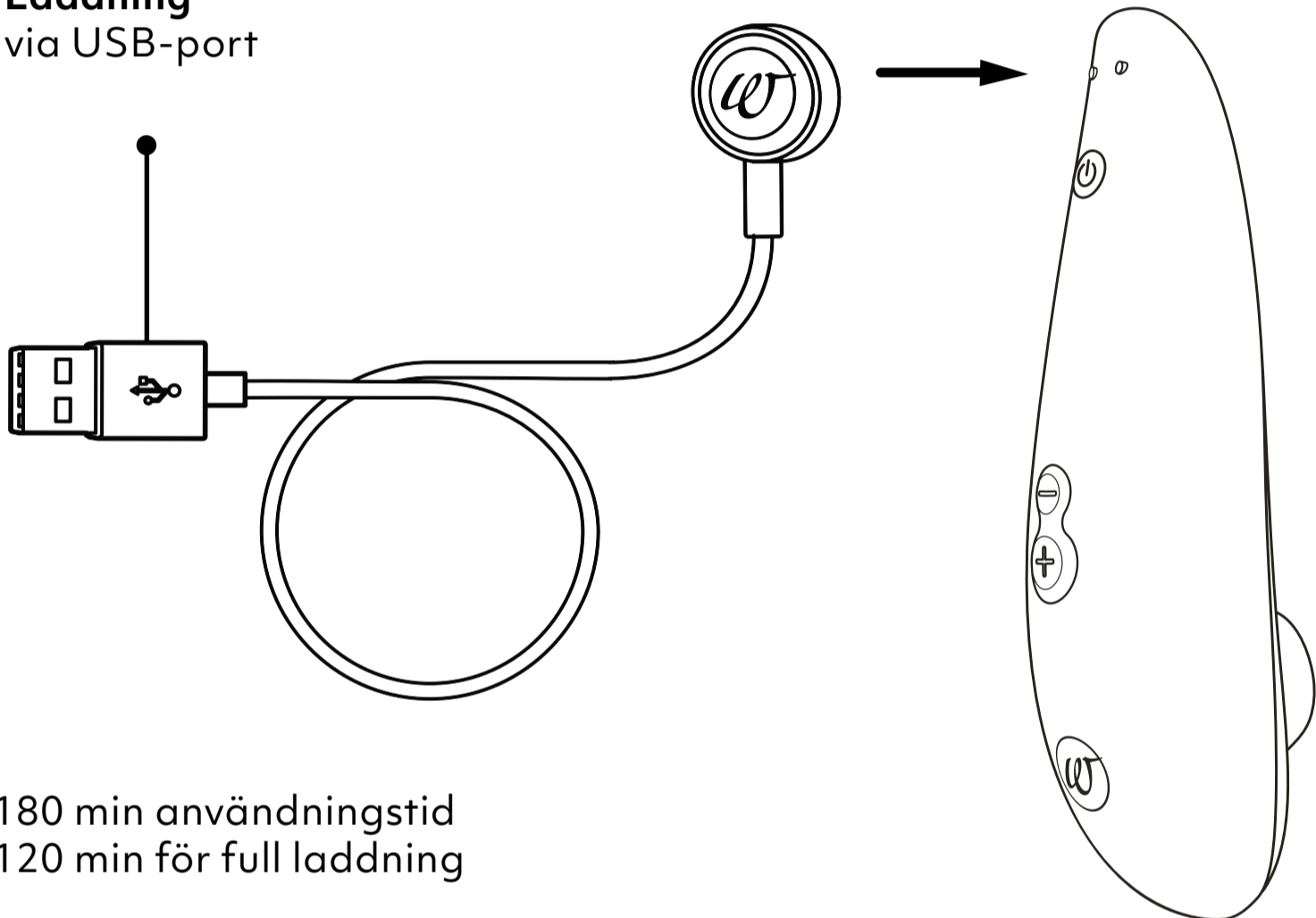

180 min användningstid
120 min för full laddning

LED-strömbrytare

Batterinivå

Fulladdad

LED tänds kontinuerligt

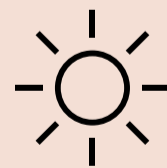

Laddad till hälften

LED blinkar snabbt

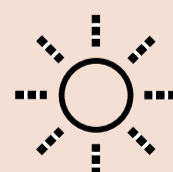

nästan urladdad

LED blinkar långsamt

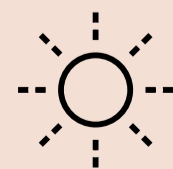

RENGÖRING

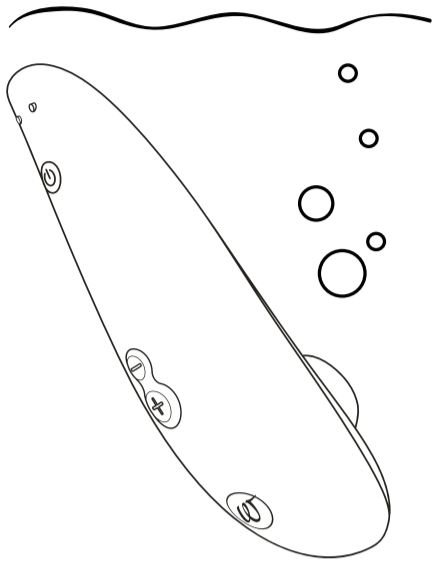

rengör under
vatten

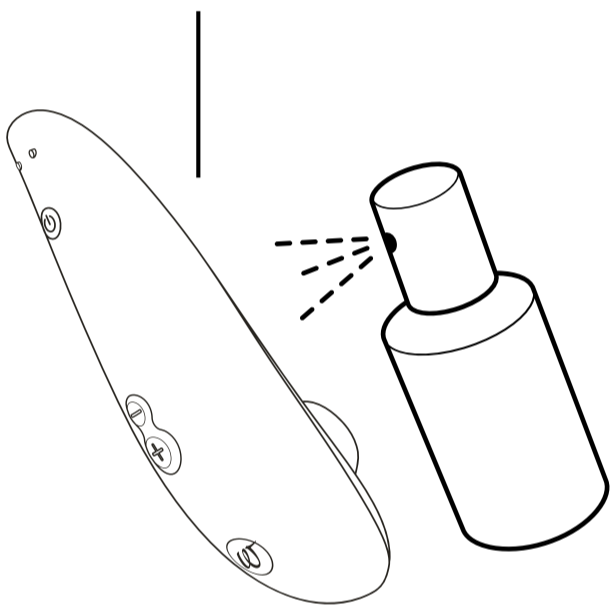

Använd rengöring
för leksaker

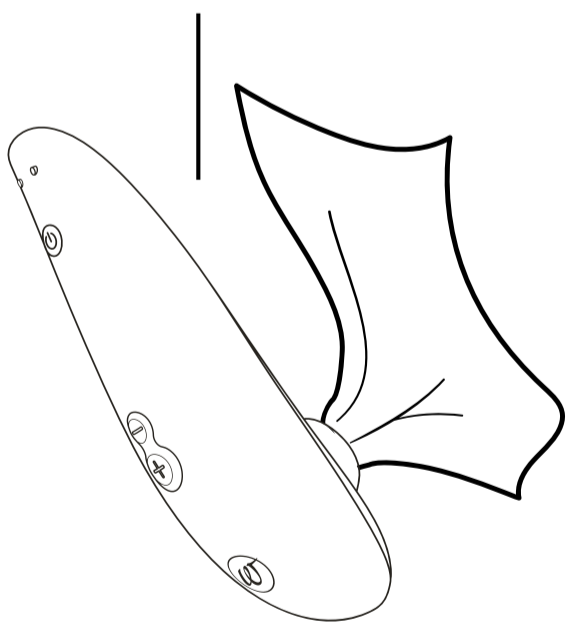

Torka

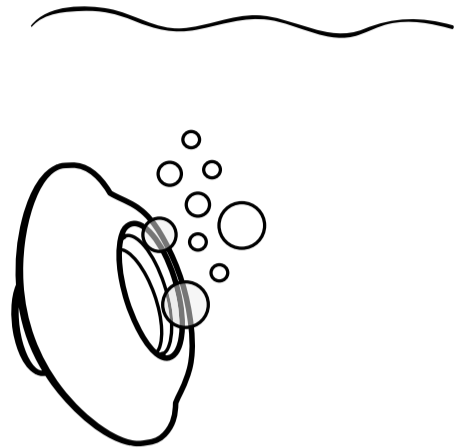

rengör under
vatten

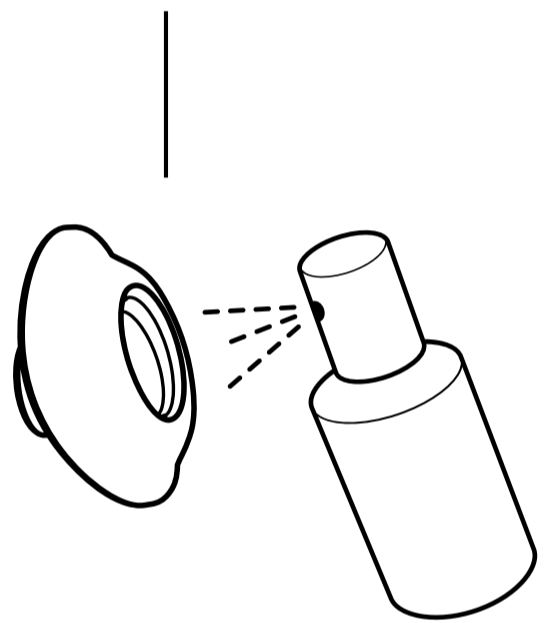

Använd rengöring
för leksaker

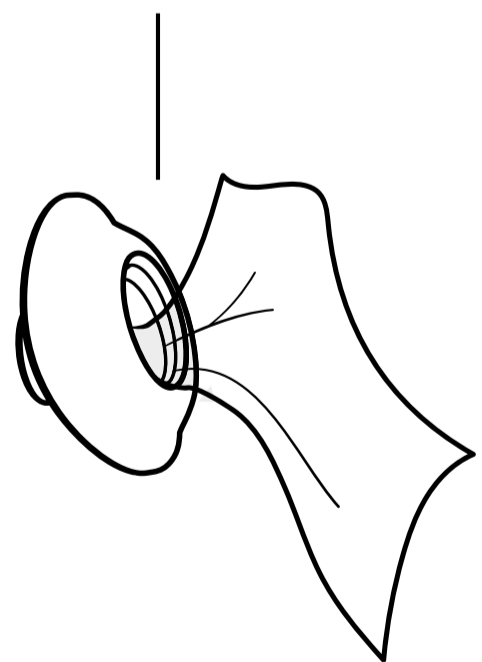

Torka



Waterproof
IPX7

ALLMÄN INFORMATION

VARNING

Läs säkerhetsinstruktionerna noggrant för mer information.

Rengör din Womanizer noggrant före första användningen och efter varje användning för att minska infektionsrisken.

KUNDTJÄNST

För mer information, gå till www.womanizer.com eller skriv till care@womanizer.com.

TEKNISKA SPECIFIKATIONER

Modell: WZ08B

Effektklass: 100–240 V ~ 50/60 Hz

Uteffekt: 5 V = 0.75 A

Innehåller uppladdningsbart litiumjonbatteri.

AC/DC-adapter ingår inte.

LEVERANSOMFÅNG

Womanizer Classic 2, USB-laddningskabel, förvaringspåse i bomull, 2 stimuleringshuvuden, snabbstartsguide, säkerhetsinstruktioner

FÖRVARING

Förvara på en säker, torr plats skyddad mot direkt solljus.

GARANTI OCH FRIVILLIG TILLVERKARGARANTI

WOW TECH EUROPE GMBH ger kunderna en frivillig tillverkargaranti för den här produkten i tillägg till den obligatoriska garanti som kunder har rätt till gentemot säljare.

Villkoren för tillverkarens frivilliga garanti finns att läsa på vår webbplats under rubriken "Warranty Conditions".

UPPFYLLANDE AV NORMER

Denna apparat uppfyller alla normer för elektromagnetisk kompatibilitet (EMC). Apparaten är säker att använda så länge den används korrekt och i enlighet med instruktionerna i denna bruksanvisning.

MILJÖSKYDD

Som distributör av elektroniska apparater är vi juridiskt skyldiga att ta emot restavfall av elektriska och elektroniska apparater utan kostnad. Vi anger

uttryckligen att du som användare är juridiskt skyldig att returnera begagnade batterier. Kasta aldrig elektrisk utrustning eller batterier i hushållsavfallet.

Symbolen som visas nedan, och som även finns på våra elektriska apparater, ska påminna om detta.

TILLVERKARE

WOW Tech Europe GmbH,
Friedenstrasse 91 / 91 a, 10249 Berlin, Tyskland

WOW Tech Europe GmbH förbehåller sig rätten att göra tekniska ändringar och ändringar i designen med syfte att förbättra apparaten.

Distribueras i Nordamerika av WOW TECH Canada Ltd. 1545 Carling Avenue, Suite 401, Ottawa ON, Kanada K1Z 8P9

www.wowtech.com Formgiven i Tyskland. Tillverkad i Kina 2021. Manual utgiven 2021-02. Version 1.

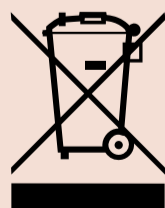

VILL DU HAMMER?

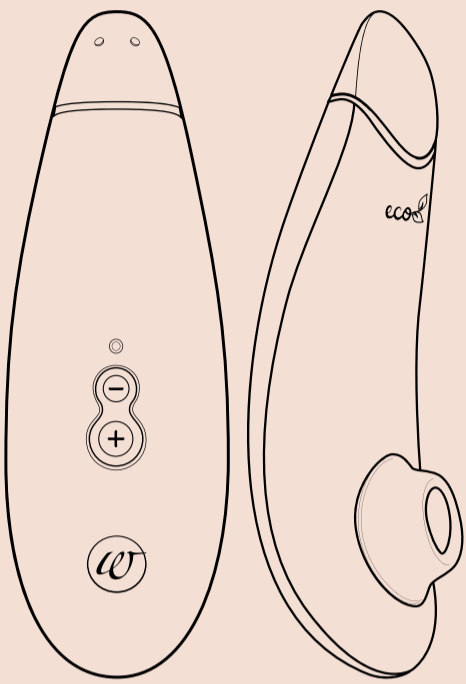

**Pleasure Air
Technology**



Smart Silence



Eco-friendly

Premium eco 

Loving Our Planet Can Be Orgasmic

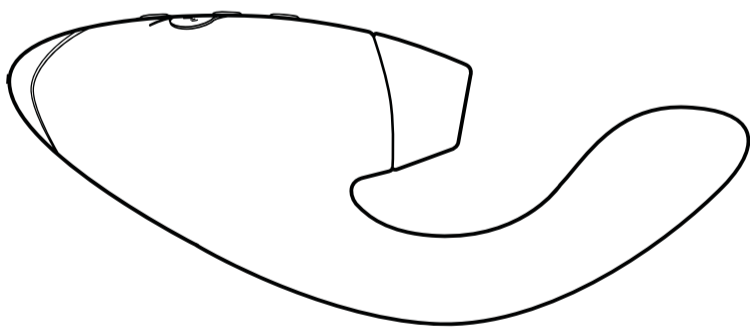

**Pleasure Air
Technology**



Vibrator



Smart Silence

DUO
Double your Pleasure



#IMASTURBATE

Olá!

Obrigado por escolheres o Womanizer!

Bem-vinda a um mundo cheio de experiências sensuais que irão enriquecer a tua vida. Ao escolheres o WOMANIZER, garantes não só orgasmos sem comparação - mas também um desejo inteiramente novo no que respeita ao prazer.

Goza o teu WOMANIZER - um orgasmo após o outro.

Força, ama-te a ti própria!



DESCRIÇÃO DO PRODUTO

COMO USAR

CARREGAR

LIMPEZA

INFORMAÇÃO GERAL

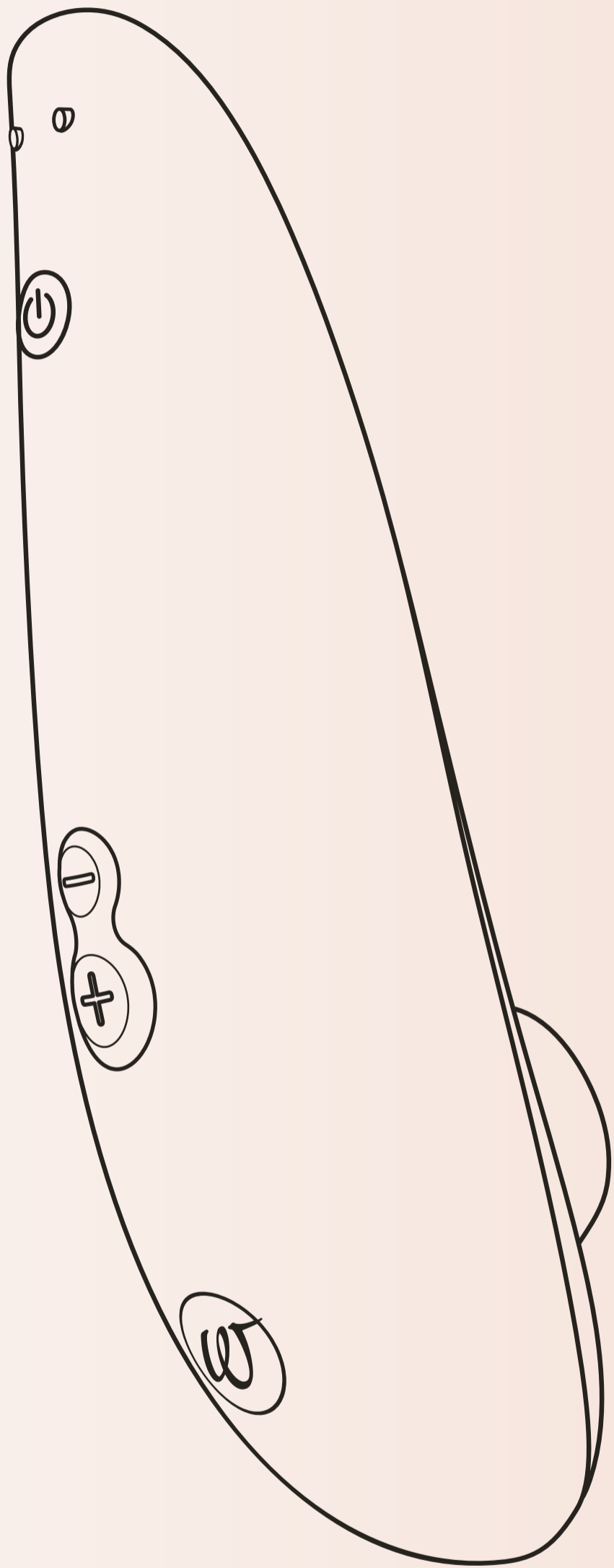

DESCRIÇÃO DO PRODUTO

Pinos de carregamento magnético

On/Off
pressiona durante 2 segundos

Funcionalidade Afterglow
pressiona brevemente

Diminuir a intensidade
pressiona brevemente

Aumentar a intensidade
pressiona brevemente

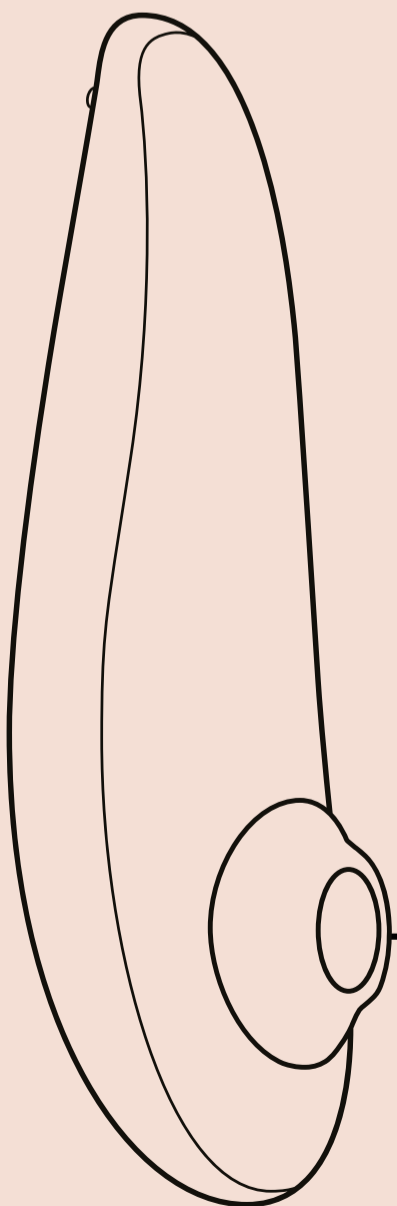
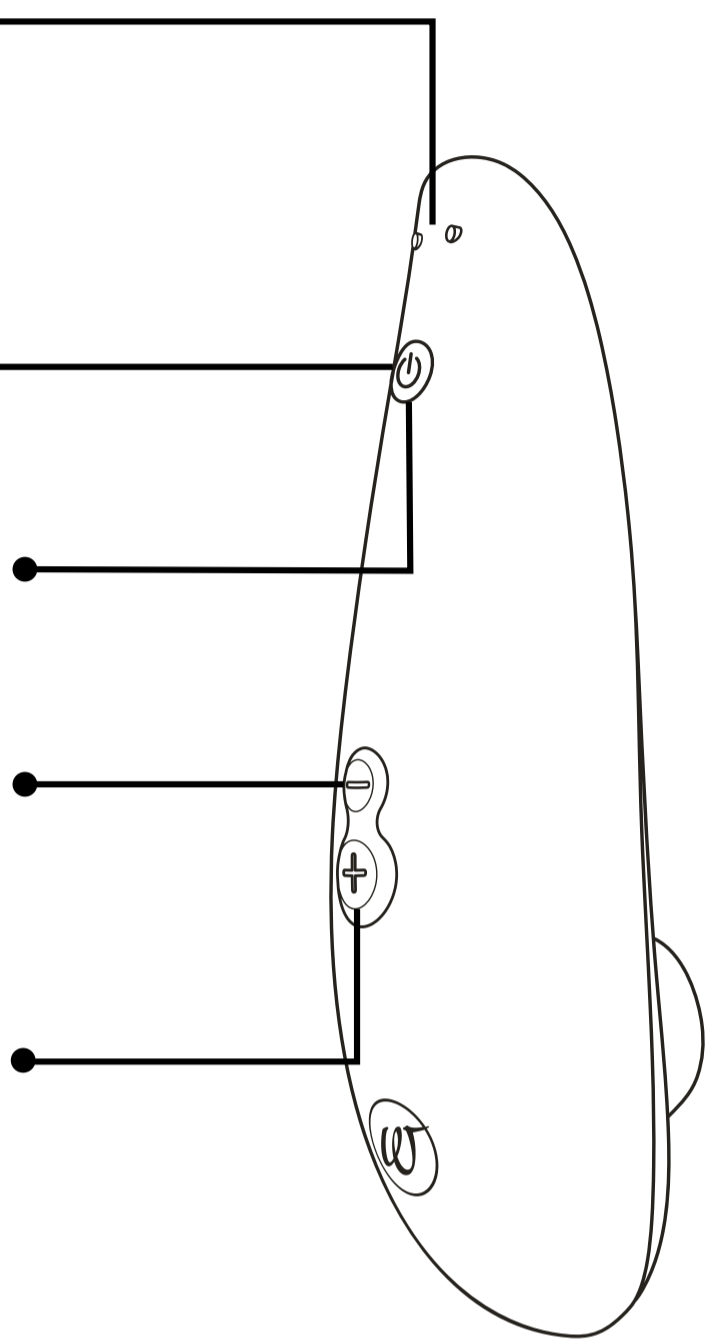

Cabeça de estimulação

COMO USAR

1. Ligar

Pressiona
durante
2 segundos

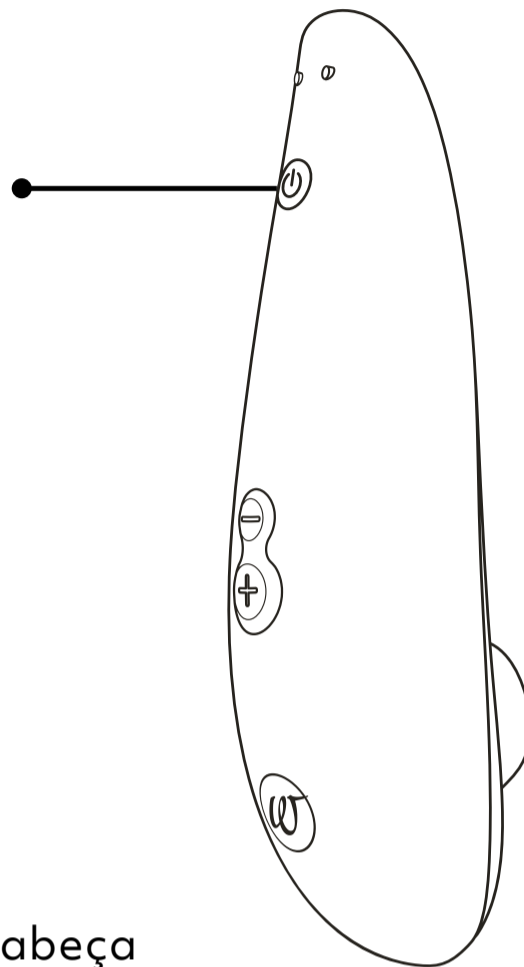

2. Utilização

Cobre o teu clítoris com a cabeça de estimulação e a tua viagem começa.

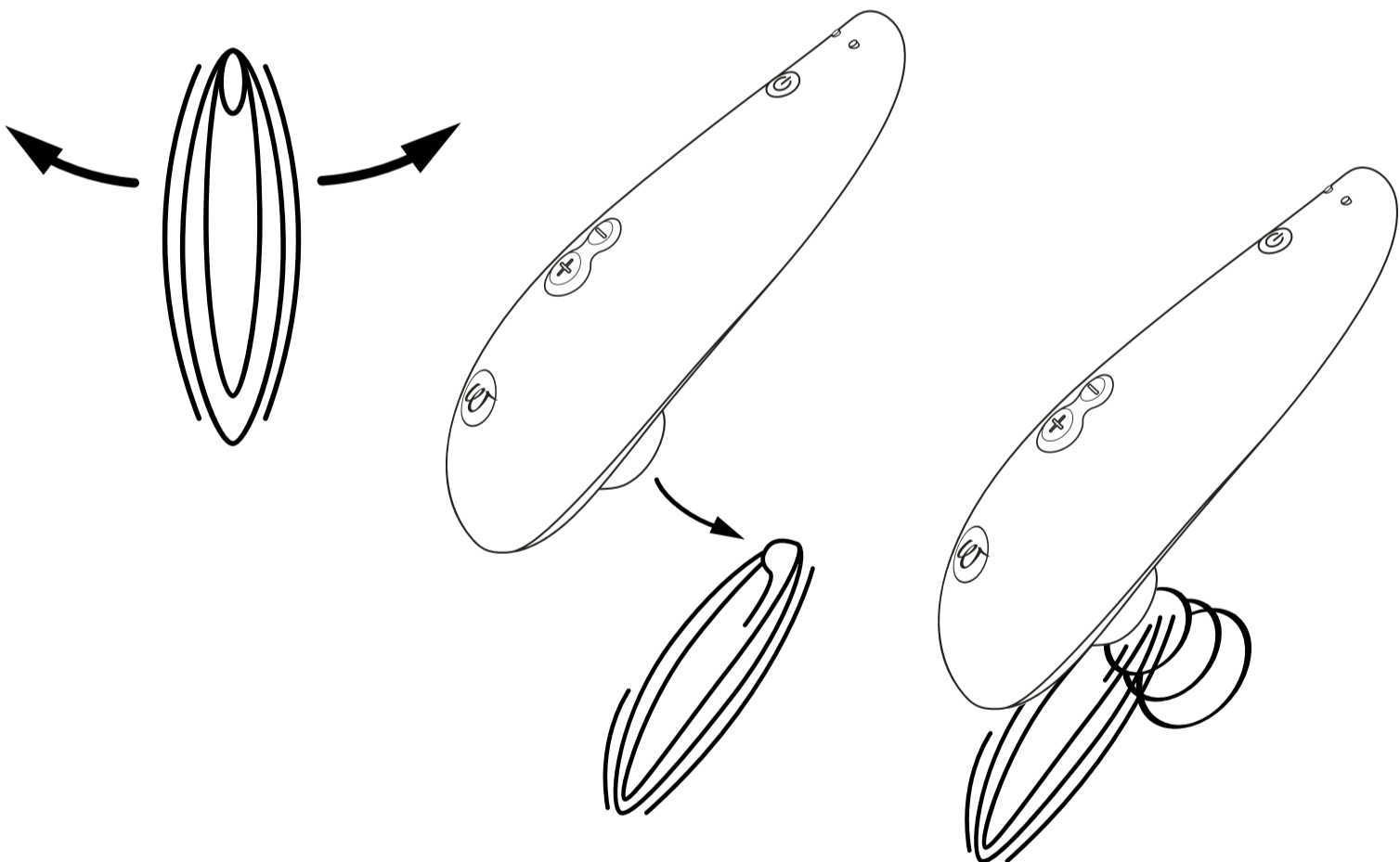

Dica:

Se notares que o acessório de estimulação ainda não se adapta perfeitamente, alterna entre os dois acessórios de estimulação (S ou M) incluídos com o dispositivo, a fim de criares a melhor experiência para ti.

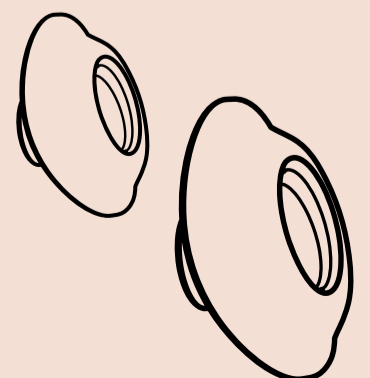

3. Mudar a intensidade

Aumentar
pressiona
brevemente

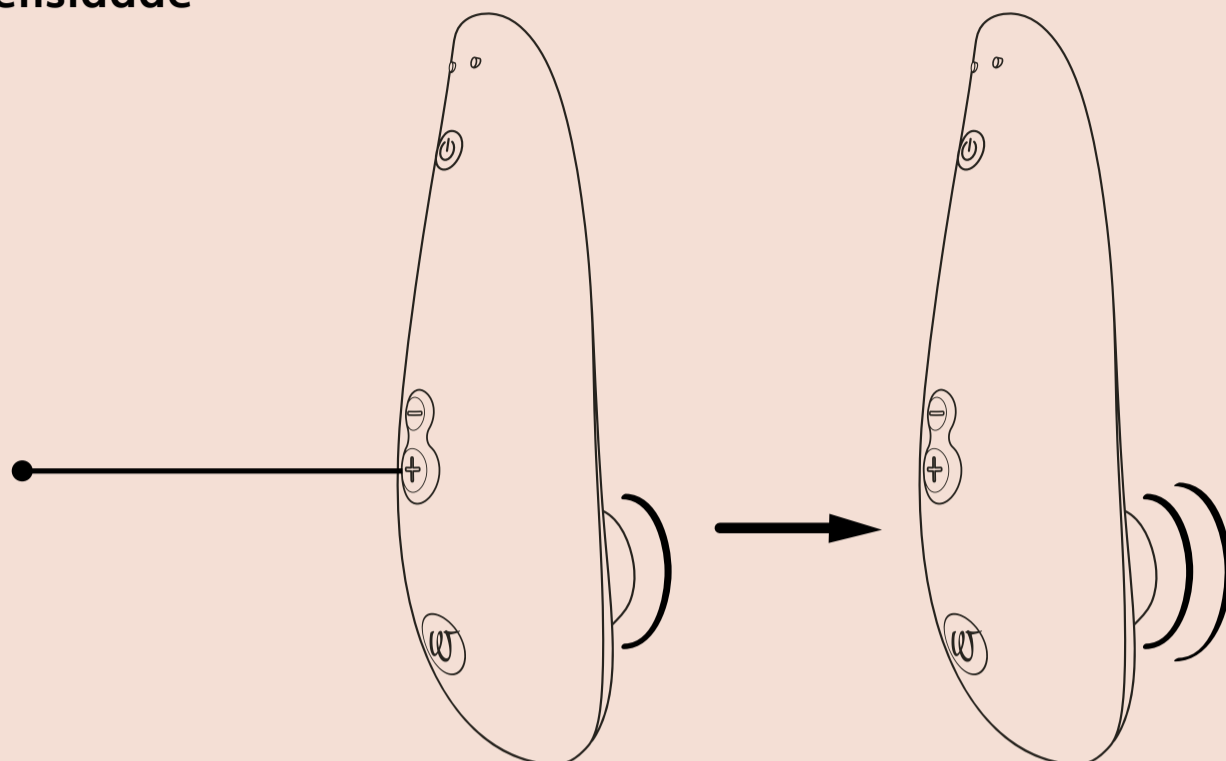

10  **Níveis de intensidade**

Diminuir
pressiona
brevemente

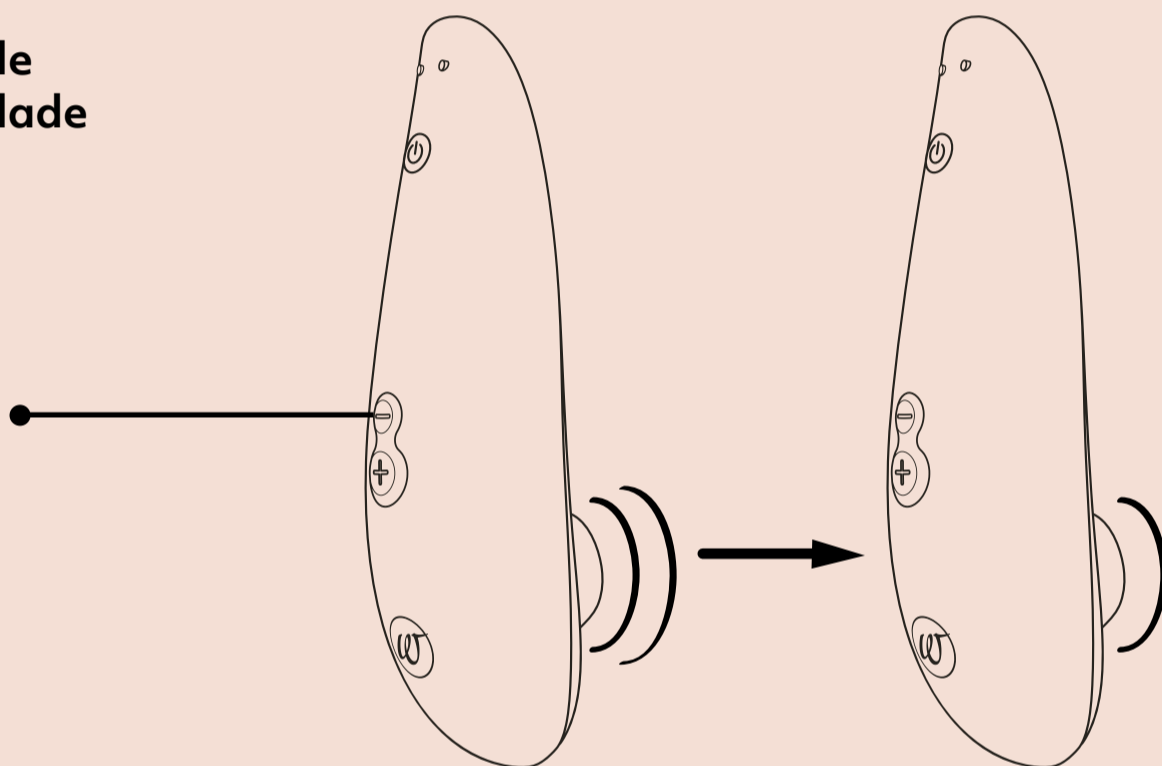

Funcionalidade Afterglow: Pressiona brevemente o botão de ligação para voltar ao nível de intensidade 1.

4. Desligar

pressiona
durante
2 segundos

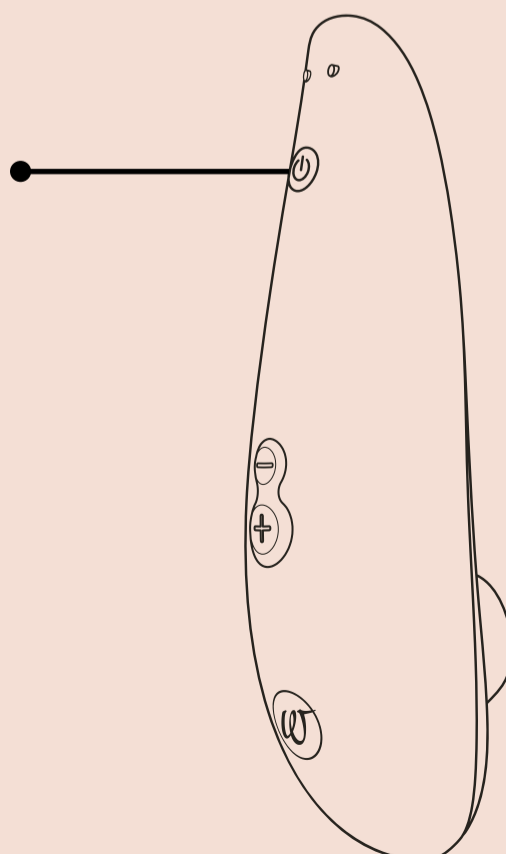

CARREGAR

Carrega o teu Womanizer antes de o usares pela primeira vez. Lembra-te também de carregares regularmente o teu Womanizer, de modo a garantires uma longa duração da bateria.

Carregamento via porta USB

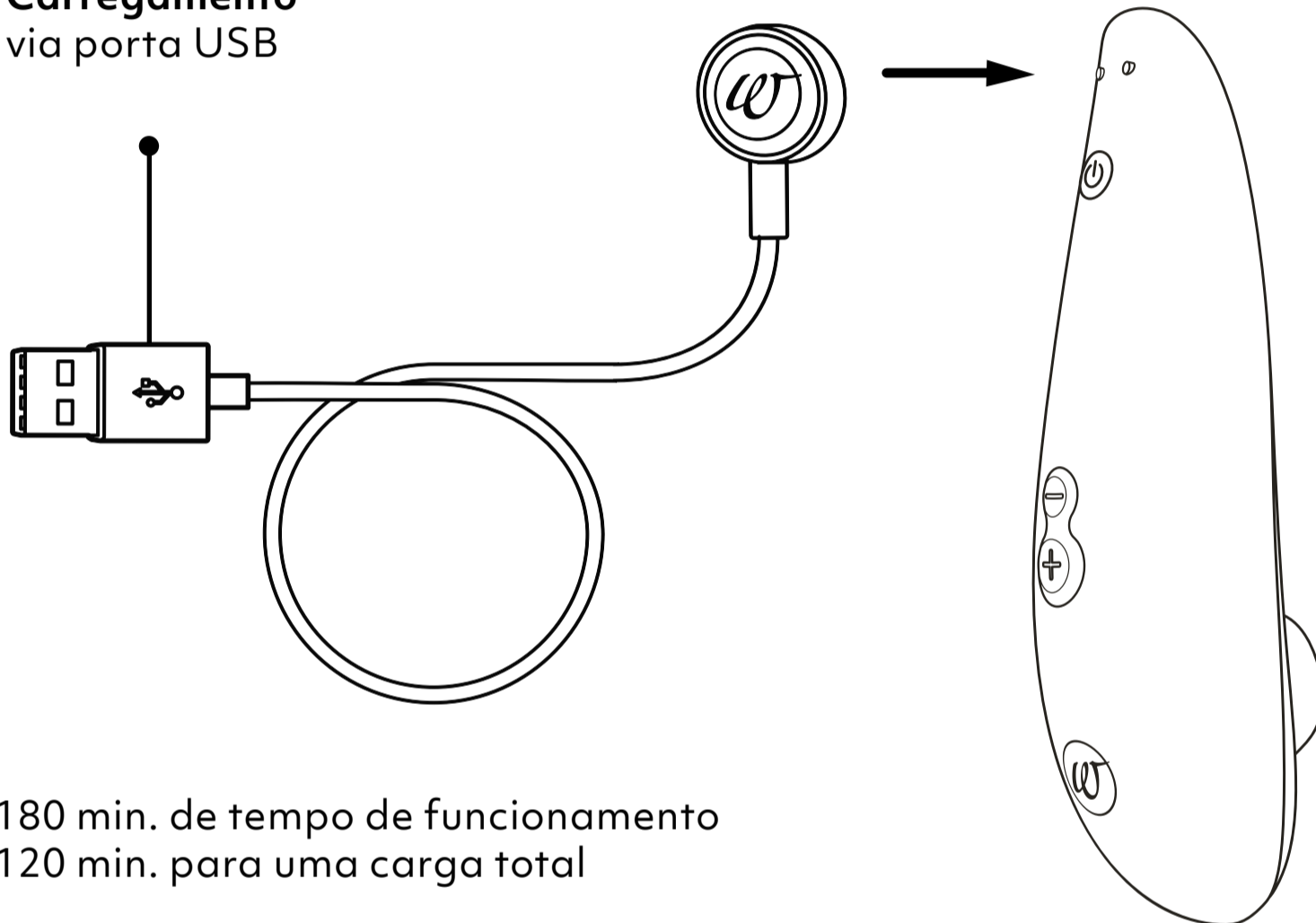

180 min. de tempo de funcionamento
120 min. para uma carga total

Botão de ligação LED

Nível da bateria

Totalmente carregada
LED acende continuamente

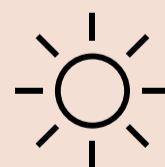

Meio carregada
LED pisca rapidamente

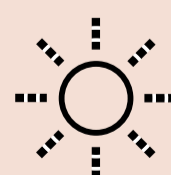

quase descarregada
LED pisca lentamente

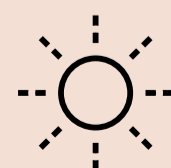

LIMPEZA

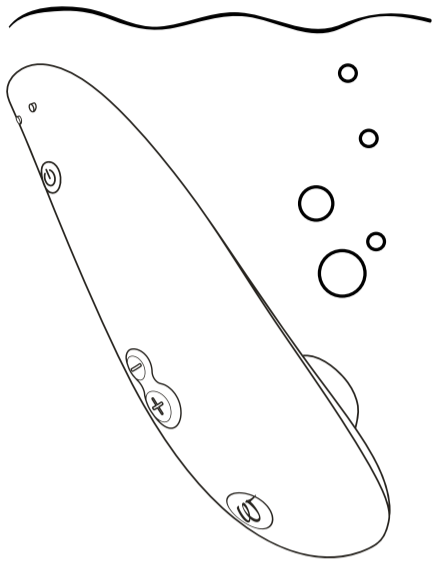

lavar debaixo de
água



Aplicar detergente
para brinquedos

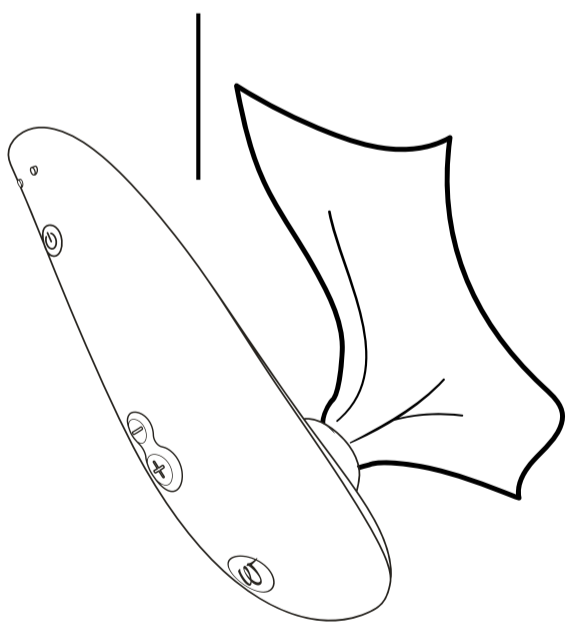

Secar

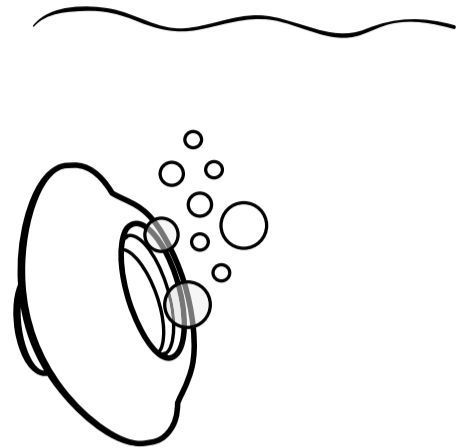

lavar debaixo de
água

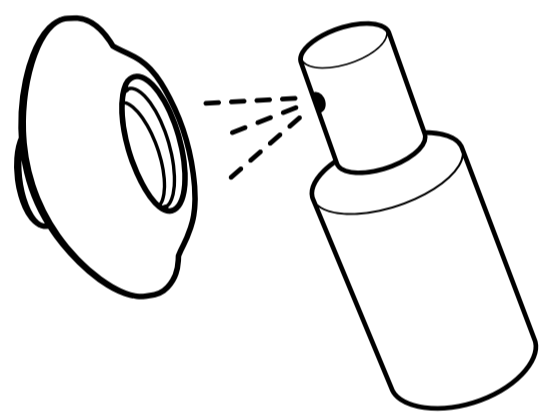

Aplicar detergente
para brinquedos

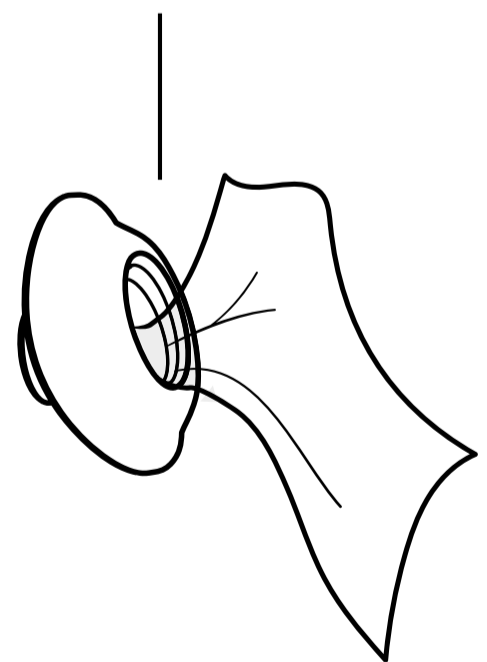

Secar



Waterproof
IPX7

INFORMAÇÃO GERAL

AVISO

Lê atentamente as instruções de segurança para mais informações.

Limpa muito bem o teu Womanizer antes de o usares pela primeira vez e após cada utilização, a fim de reduzir o risco de infeções.

ASSISTÊNCIA AO CLIENTE

Para mais informações, visita o nosso website www.womanizer.com ou contacta o endereço care@womanizer.com.

ESPECIFICAÇÕES TÉCNICAS

Modelo: WZ08B

Potência nominal: 100-240 V ~ 50/60 Hz

Saída: 5 V = 0.75 A

Contém uma bateria recarregável de íões de lítio.

Adaptador CA/CC não incluído.

CONTEÚDO

Womanizer Classic 2, cabo de carga USB, bolsa de armazenamento em algodão, 2 cabeças de estimulação, guia de início rápido, instruções de segurança.

ARMAZENAMENTO

Conservar num local seguro e seco, sem exposição direta à luz solar.

GARANTIA E GARANTIA VOLUNTÁRIA DO FABRICANTE

A WOW TECH EUROPE GMBH disponibiliza aos seus clientes uma garantia voluntária do fabricante para este produto, para além da garantia obrigatória a que os consumidores têm direito perante os vendedores.

As condições relativas à garantia voluntária do fabricante encontram-se no nosso website, em "Condições de Garantia".

CUMPRIMENTO DAS NORMAS

Este aparelho cumpre com todas as normas relativas à compatibilidade eletromagnética (CEM). O dispositivo pode ser utilizado em segurança desde que seja usado corretamente e de acordo com as instruções dadas neste manual do utilizador.

PROTECÇÃO AMBIENTAL

Como distribuidores de dispositivos eletrónicos, somos legalmente obrigados a aceitar a devolução gratuita de dispositivos eletrónicos e elétricos usados. Declaramos expressamente que o utilizador tem a obrigação legal de devolver as baterias usadas. Nunca coloque os dispositivos eletrónicos ou baterias no lixo doméstico. O símbolo que se segue, que também se encontra nos nossos artigos eletrónicos, destina-se especificamente a lembrar este facto.

FABRICANTE

WOW Tech Europe GmbH,
Friedenstrasse 91 / 91 a, 10249 Berlin, Alemanha

A WOW Tech Europe GmbH reserva-se o direito de introduzir alterações técnicas e alterações ao design destinadas a melhorar o dispositivo.

Distribuído na América do Norte pela WOW TECH Canada Ltd. 1545 Carling Avenue, Suite 401, Ottawa ON, Canadá K1Z 8P9

www.wowtech.com Concebido na Alemanha. Fabricado na China em 2021. Manual redigido em 02/2021. Versão 1.

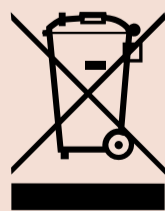

AINDA QUERES MAIS?

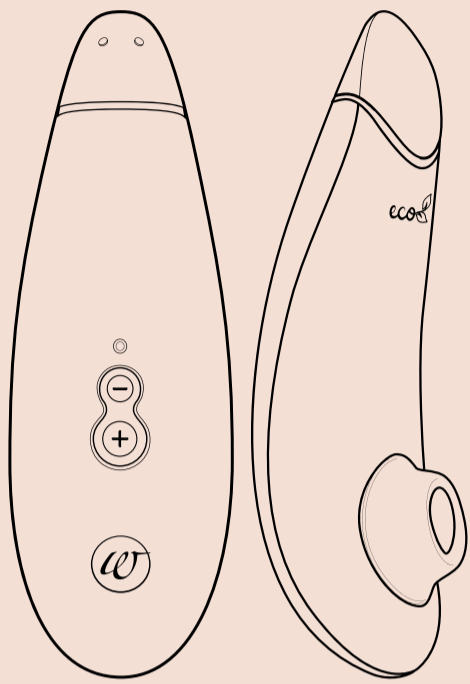

**Pleasure Air
Technology**



Smart Silence



Eco-friendly

Premium eco 

Loving Our Planet Can Be Orgasmic

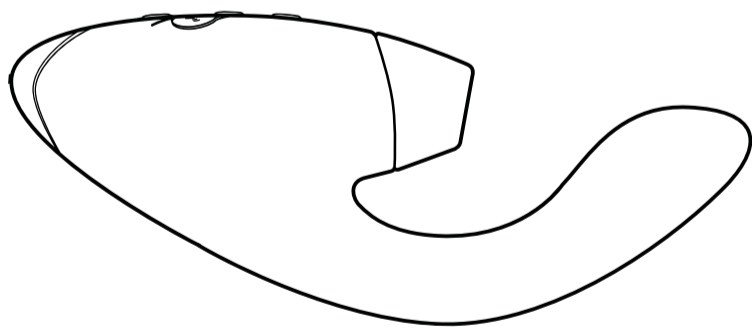

**Pleasure Air
Technology**



Vibrator



Smart Silence

DUO
Double your Pleasure



#IMASTURBATE

Ciao!

Grazie per aver scelto Womanizer!

Benvenuta in un mondo di esperienze sensuali che arricchiranno la tua vita. Scegliendo WOMANIZER, non solo avrai la certezza di raggiungere orgasmi pazzeschi, ma riscoprirai anche il desiderio di provare piacere.

Goditi il tuo WOMANIZER. Un orgasmo dopo l'altro.

Vai, amati!



DESCRIZIONE DEL PRODOTTO

ISTRUZIONI PER L'USO

RICARICA

PULIZIA

INFORMAZIONI GENERALI

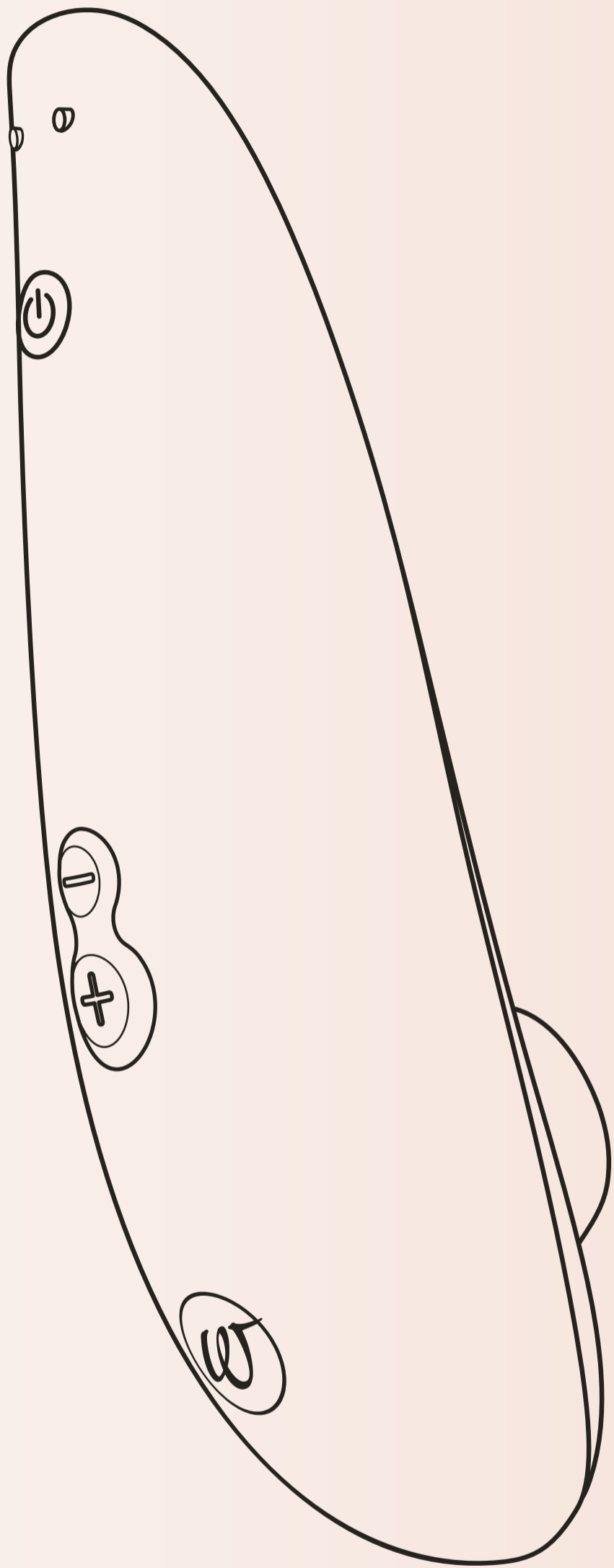

DESCRIZIONE DEL PRODOTTO

**Pin per ricarica
magnetica**

On/Off
premi per 2 secondi

Funzione Afterglow
premi brevemente

Ridurre l'intensità
premi brevemente

Aumentare l'intensità
premi brevemente

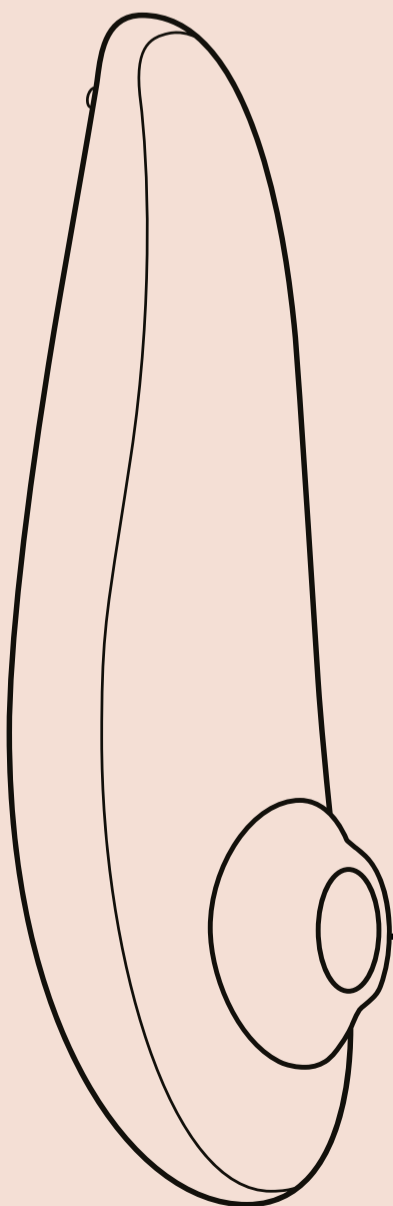
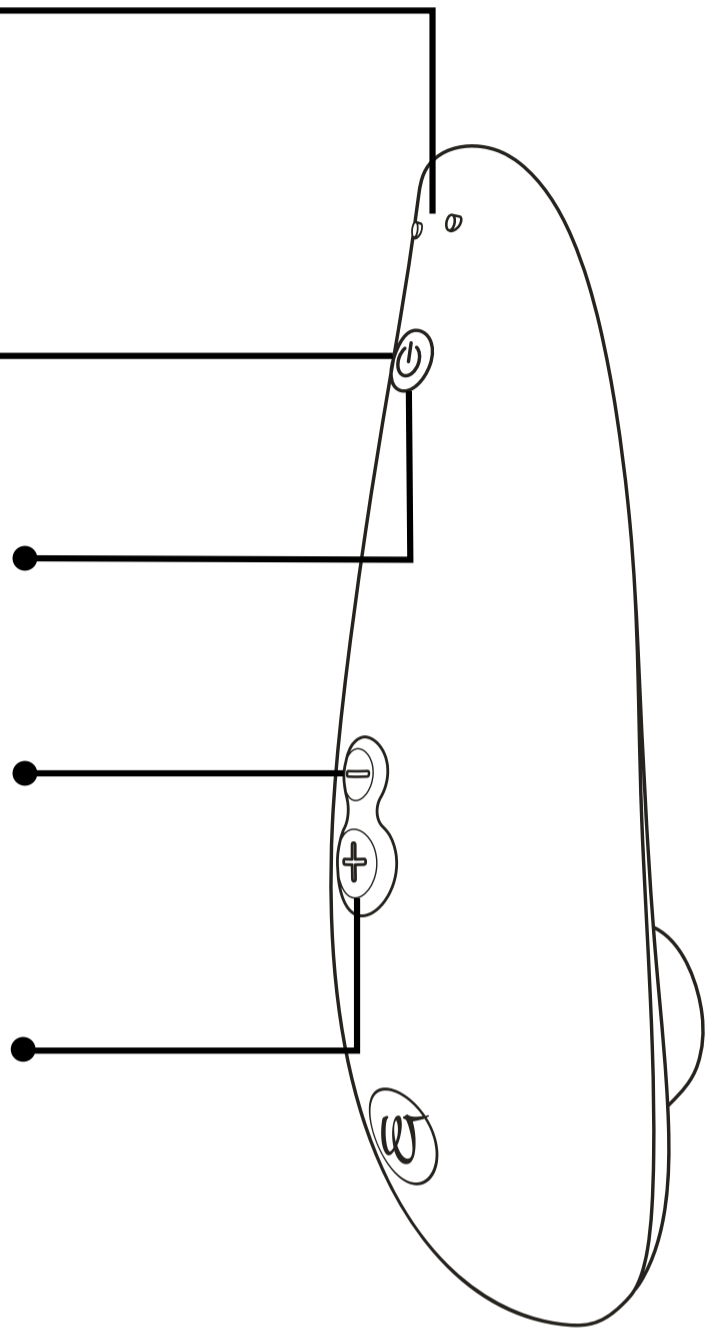

Testina stimolante

ISTRUZIONI PER L'USO

1. Accensione

Premi per
2 secondi

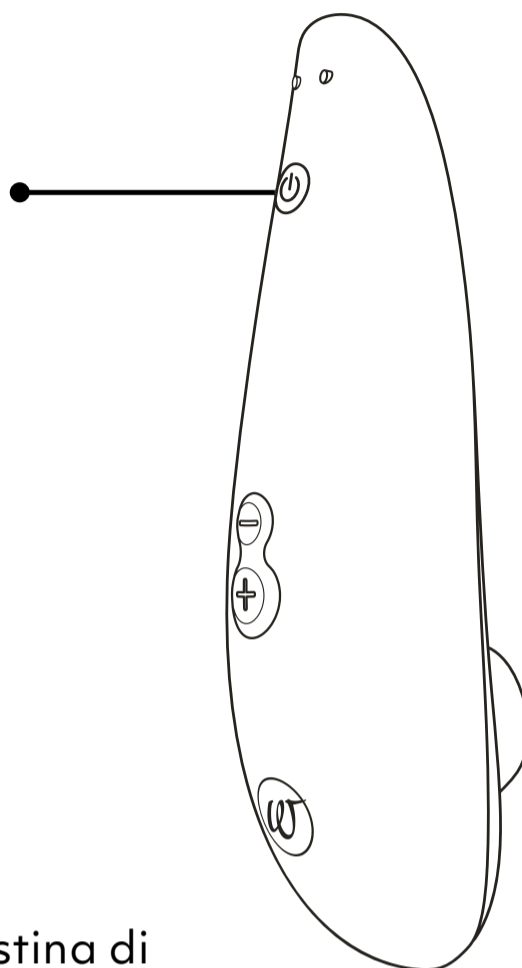

2. Uso

Avvolgi il clitoride con la testina di stimolazione per iniziare il tuo viaggio.

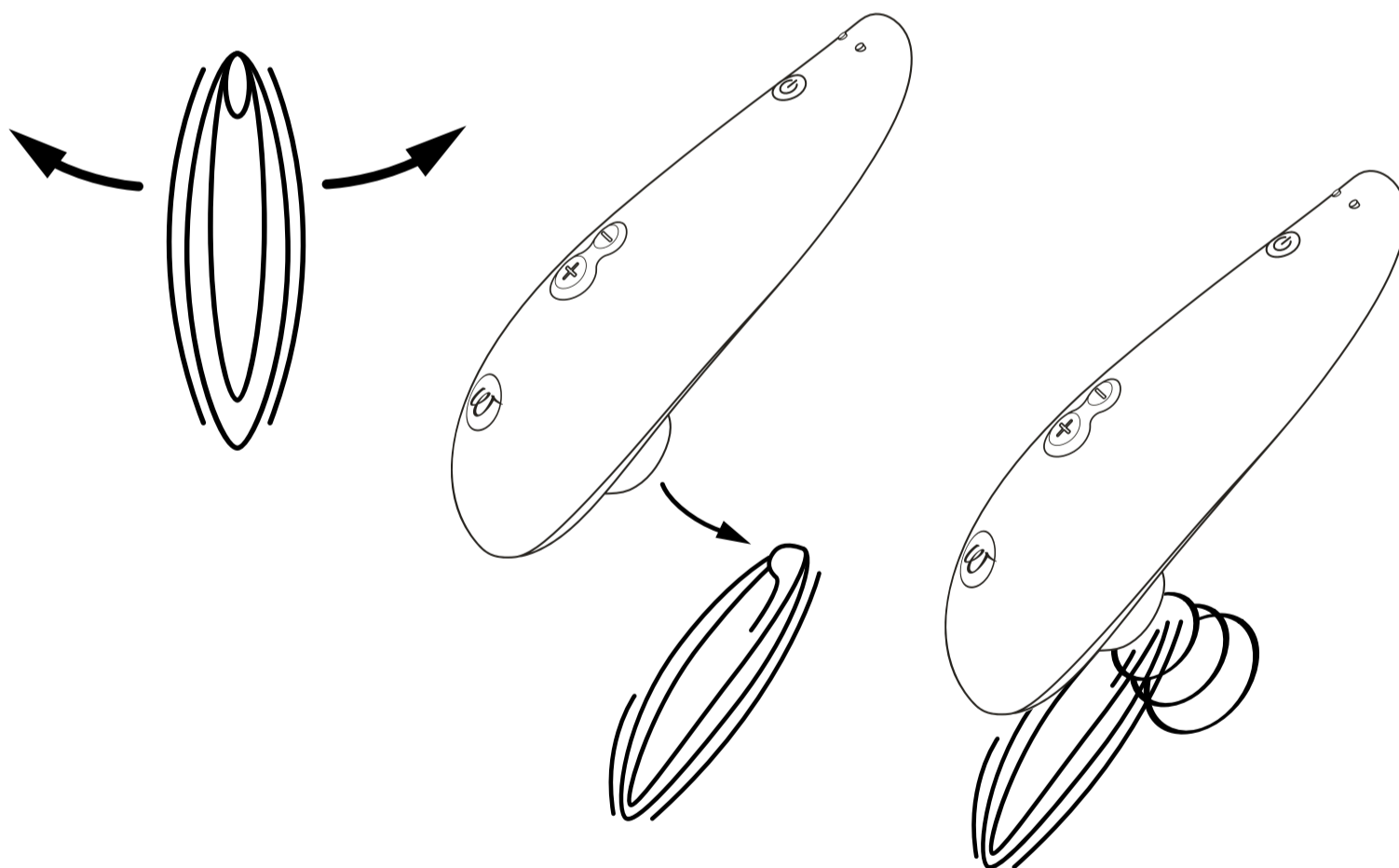

Un piccolo consiglio:

se ti accorgi che la testina di stimolazione non è quella più adatta alle tue esigenze, puoi alternare le due testine (S o M) in dotazione per creare il piacere su misura per te.

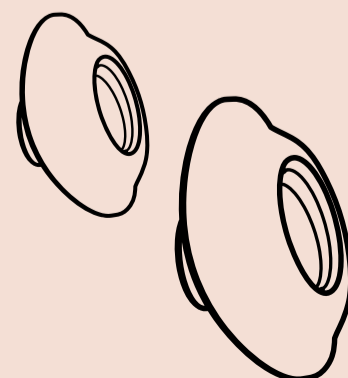

3. Cambio di intensità

Aumentare
premi brevemente

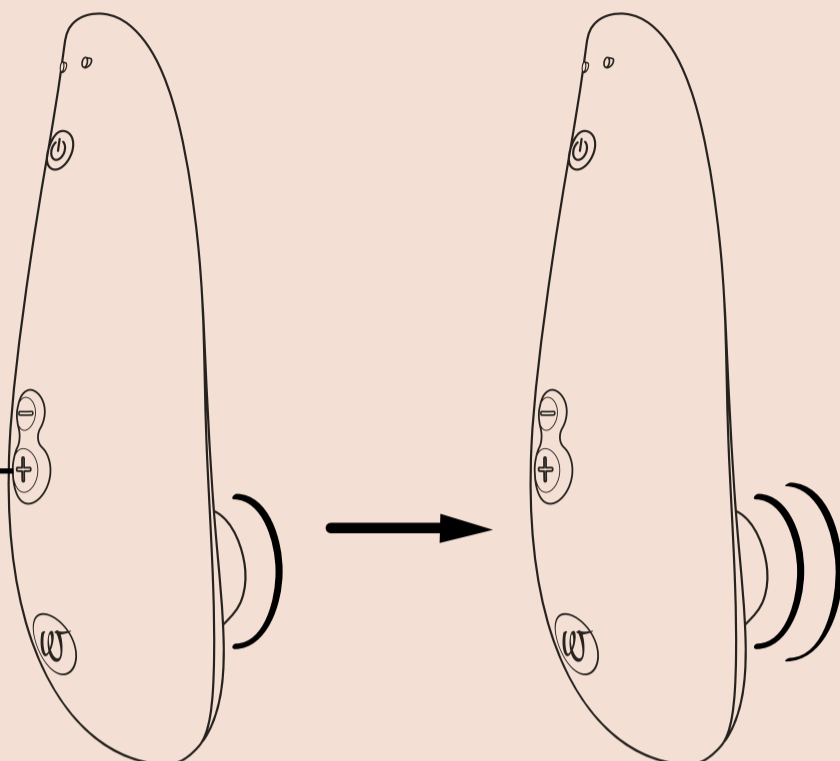

10  **Livelli di intensità**

Ridurre
premi brevemente

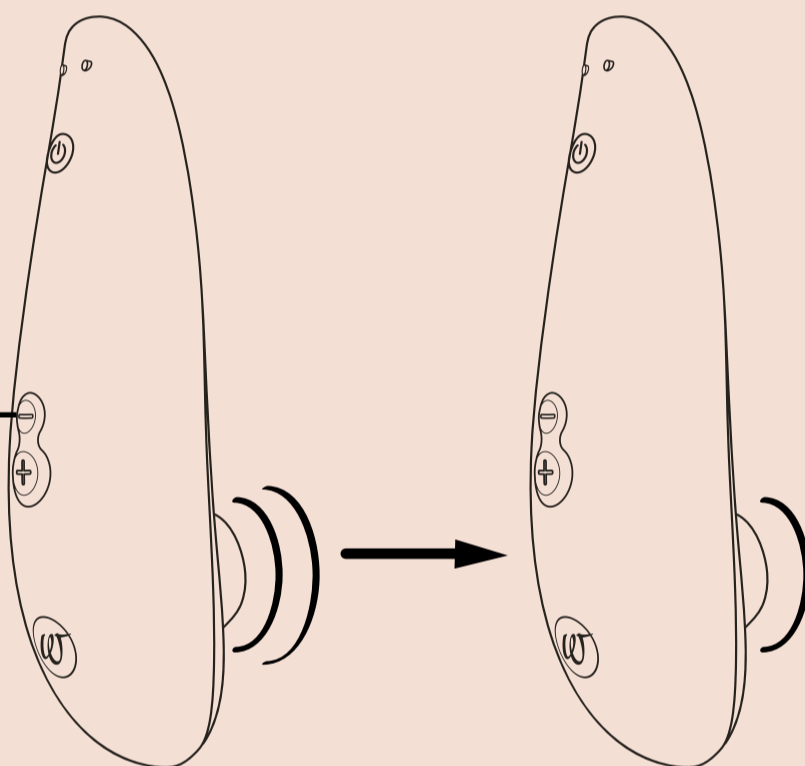

Funzione Afterglow: premi brevemente il pulsante di accensione per tornare al livello di intensità 1.

4. Spegnere

premi per
2 secondi

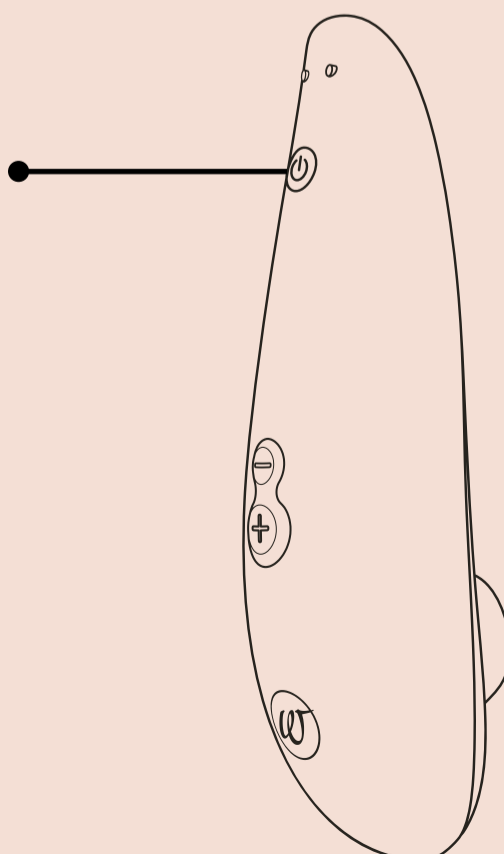

RICARICA

Prima di inaugurarlo, ti invitiamo a caricare il tuo Womanizer.
E ricorda di ricaricarlo regolarmente, per garantire una lunga durata della batteria.

Ricarica
tramite porta USB

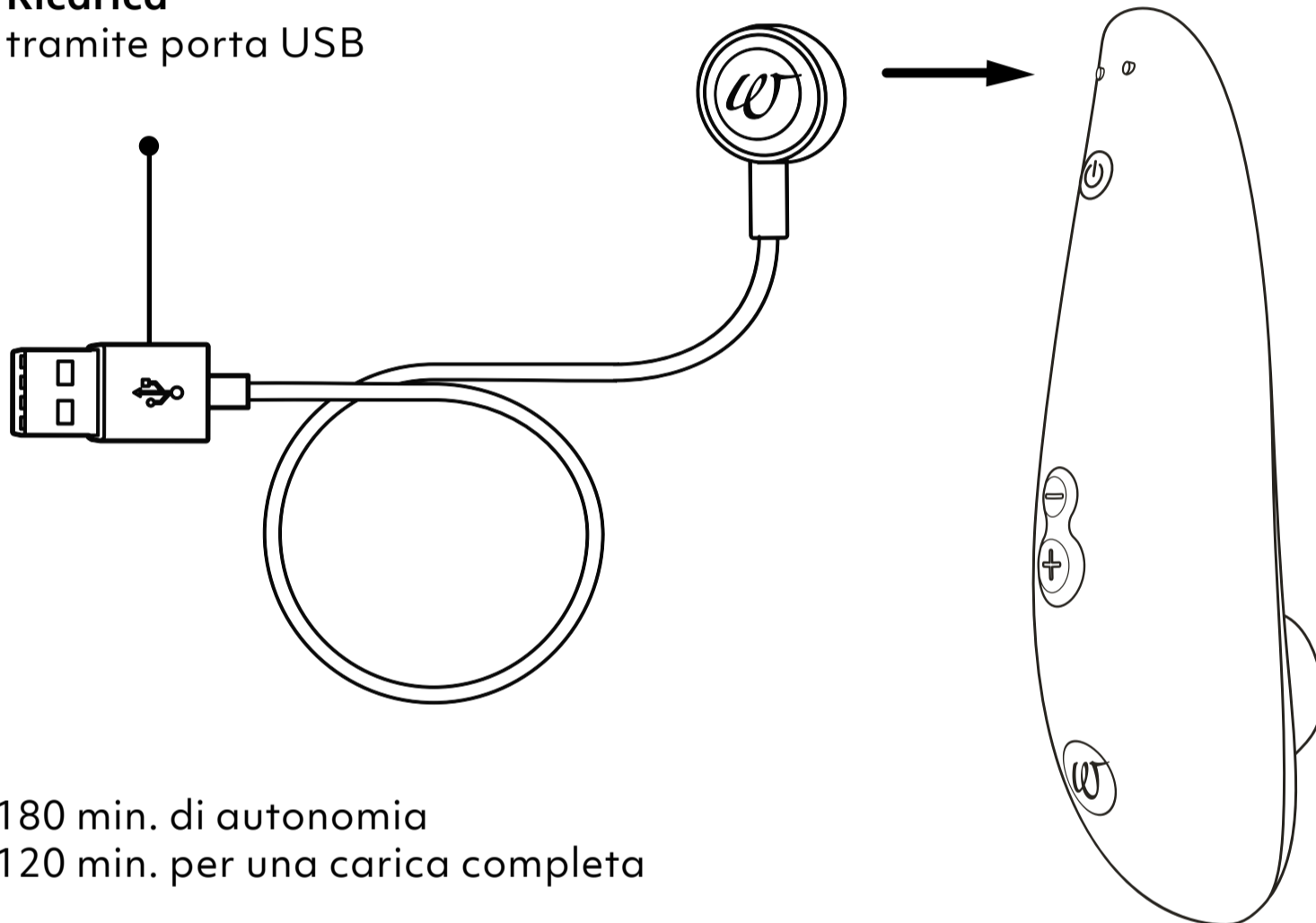

180 min. di autonomia
120 min. per una carica completa

Pulsante on/off a LED

Livello della batteria

Carica completa

Il LED resta acceso

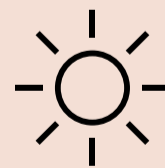

Metà carica

Il LED lampeggia velocemente

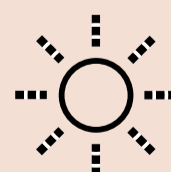

Quasi scarico

Il LED lampeggia lentamente

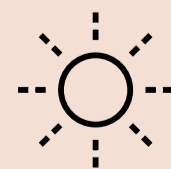

PULIZIA

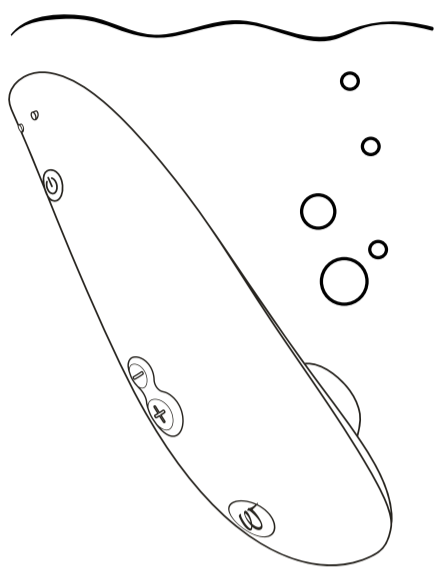

lavalo sotto
l'acqua corrente

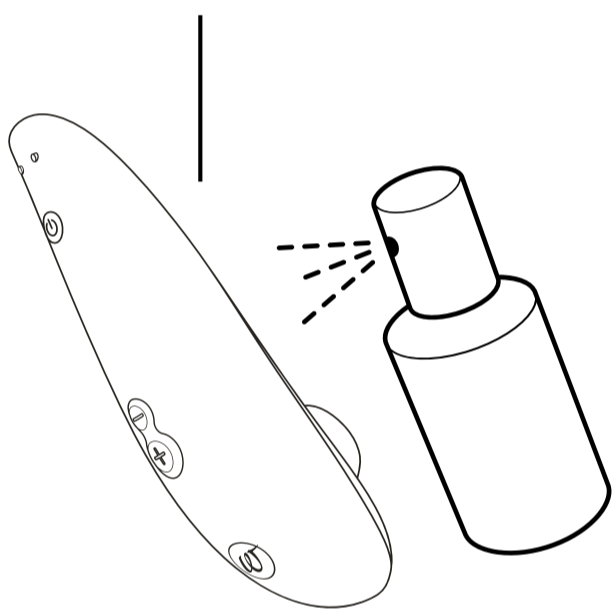

Applicare detergente
speciale

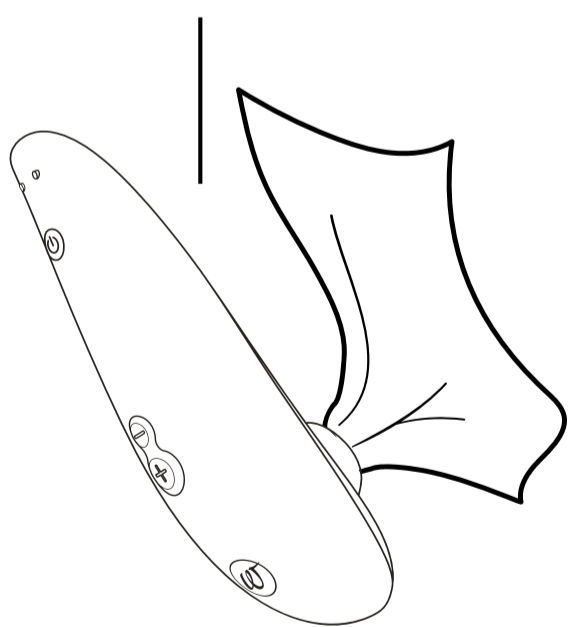

Asciugare

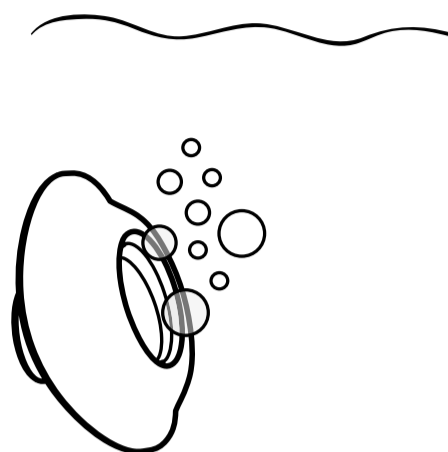

lavalo sotto
l'acqua corrente

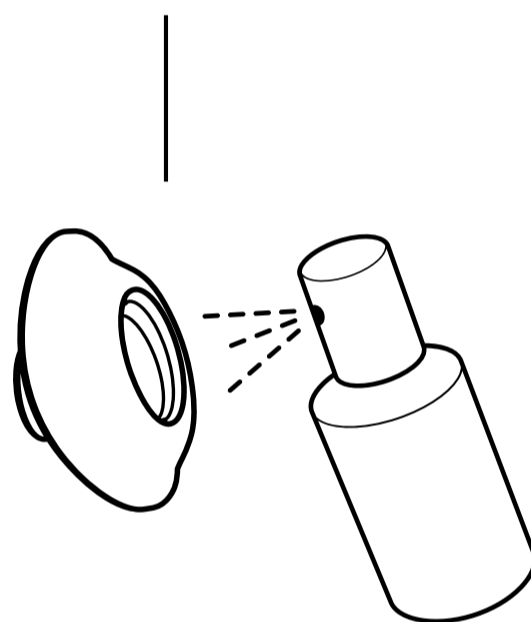

Applicare detergente
speciale

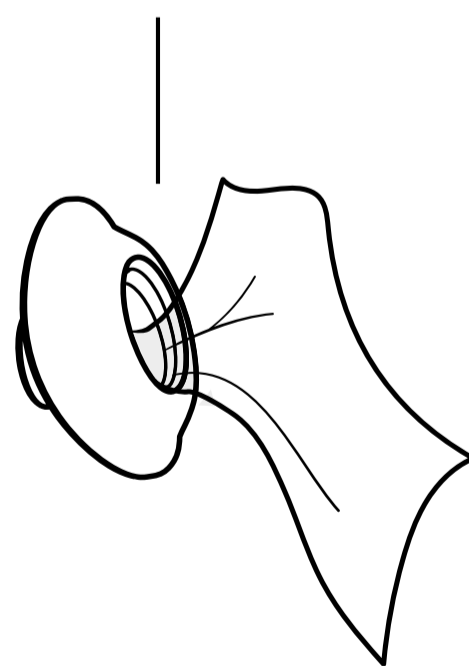

Asciugare



Waterproof
IPX7

INFORMAZIONI GENERALI

ATTENZIONE

Leggi attentamente le istruzioni di sicurezza per maggiori informazioni. Pulisci accuratamente il tuo Womanizer prima di inaugurarlo e dopo ogni uso, per ridurre il rischio di infezioni.

CUSTOMER CARE

Per maggiori informazioni visita il nostro sito www.womanizer.com o contattaci all'indirizzo care@womanizer.com.

SPECIFICHE TECNICHE

Modello: WZ08B

Potenza nominale: 100-240 V ~ 50/60 Hz

Potenza in uscita: 5 V \Rightarrow 0.75 A

Contiene una batteria ricaricabile agli ioni di litio

Adattatore AC/DC non incluso.

CORREDO DI FORNITURA

Womanizer Classic 2, cavo di ricarica USB, pochette di cotone, 2 testine di stimolazione, guida d'uso rapida, istruzioni di sicurezza.

CONSERVAZIONE

Conservare in un luogo sicuro e asciutto al riparo dalla luce diretta del sole.

GARANZIA E GARANZIA VOLONTARIA DEL PRODUTTORE

Per questo prodotto, WOW TECH EUROPE GMBH offre una garanzia volontaria del produttore, in aggiunta alla garanzia di legge a cui l'acquirente ha diritto nei confronti del venditore. I termini e le condizioni della garanzia volontaria del produttore sono consultabili sul nostro sito web alla voce "Warranty Conditions".

CONFORMITÀ A NORME

Questo dispositivo è conforme alle norme riguardanti la compatibilità elettromagnetica (EMC). L'utilizzo del dispositivo è sicuro a condizione che venga usato correttamente e nel rispetto delle istruzioni fornite in questo manuale.

PROTEZIONE AMBIENTALE

Essendo distributori di dispositivi elettronici, siamo legalmente tenuti ad accettare gratuitamente la restituzione di apparecchiature elettriche ed elettroniche da smaltire. Ti informiamo esplicitamente che, in veste di utilizzatore, sei obbligato per legge a restituire le batterie usate. I dispositivi elettronici o le batterie non devono mai essere smaltiti con i normali rifiuti domestici.

Per ricordartelo, anche sui nostri dispositivi elettronici è riportato il simbolo che vedi qui sotto.

PRODUTTORE

WOW Tech Europe GmbH,
Friedenstrasse 91 / 91 a, 10249 Berlin, Germany

WOW Tech Europe GmbH reserves the right to make technical changes and changes to the design that serve to improve the device.

Distribuito in Nord America da WOW TECH Canada Ltd. 1545 Carling Avenue, Suite 401, Ottawa ON, Canada K1Z 8P9

www.wowtech.com Progettato in Germania. Made in China nel 2021. Manuale pubblicato a 02/2021. Versione 1.

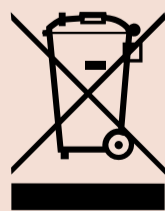

NE VUOI ANCORA?

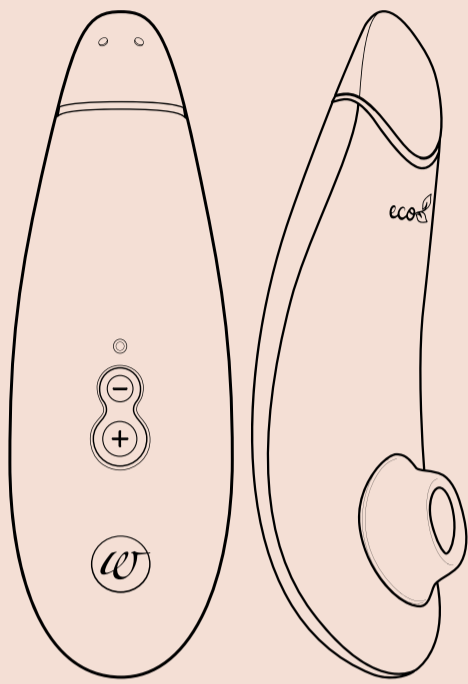

**Pleasure Air
Technology**



Smart Silence



Eco-friendly

Premium eco 

Loving Our Planet Can Be Orgasmic

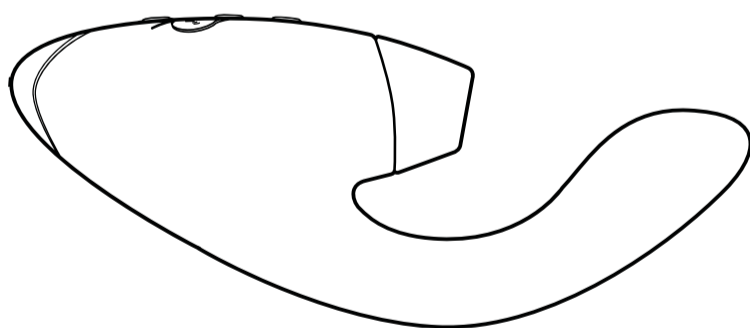

**Pleasure Air
Technology**



Vibrator



Smart Silence

DUO

Double your Pleasure



#IMASTURBATE

Hej!

Tak fordi du valgte Womanizer

Velkommen til en verden fuld af sanselige oplevelser, der vil berige dit liv. Ved at vælge WOMANIZER er du ikke kun garanteret orgasmer, der er uden sammenligning - men også en helt ny lyst til nydelse.

Nyd din WOMANIZER - den ene orgasme efter den anden.

Af sted, elsk dig selv!



PRODUKTBESKRIVELSE

SÅDAN BRUGES PRODUKTET

OPLADNING

RENGØRING

GENEREL INFORMATION

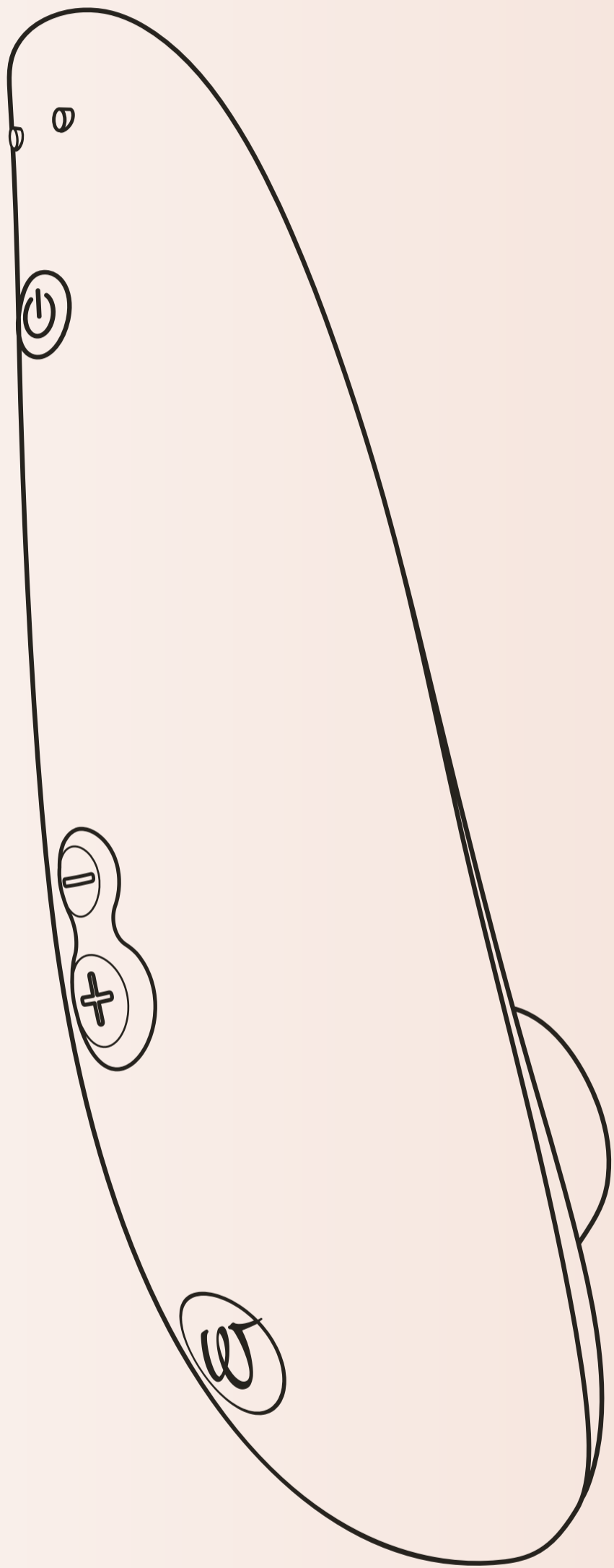

PRODUKTBESKRIVELSE

Magnetiske ladeben

Tænd/Sluk
tryk i 2 sekunder

Afterglow Feature
tryk let

Sænk intensitet
tryk let

Øg intensitet
tryk let

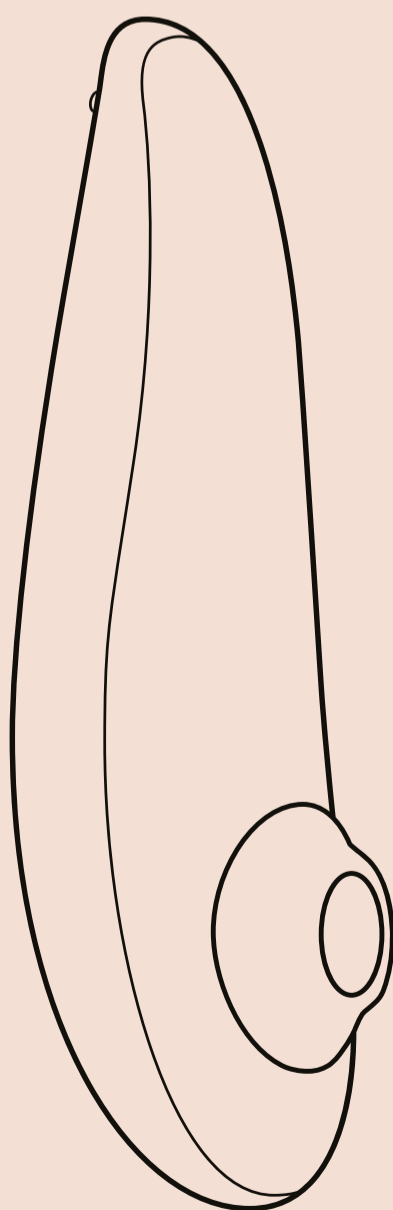
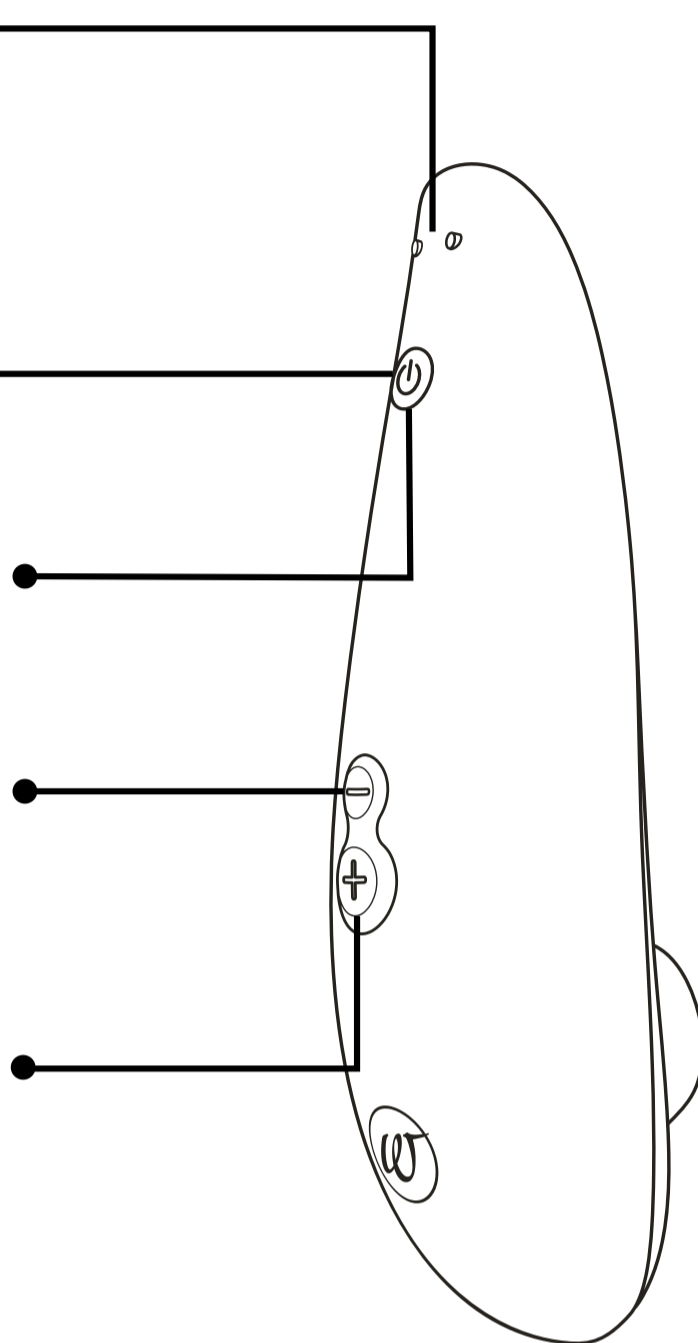

Stimuleringshoved

SÅDAN BRUGES PRODUKTET

1. Tænd

Tryk i
2 sekunder

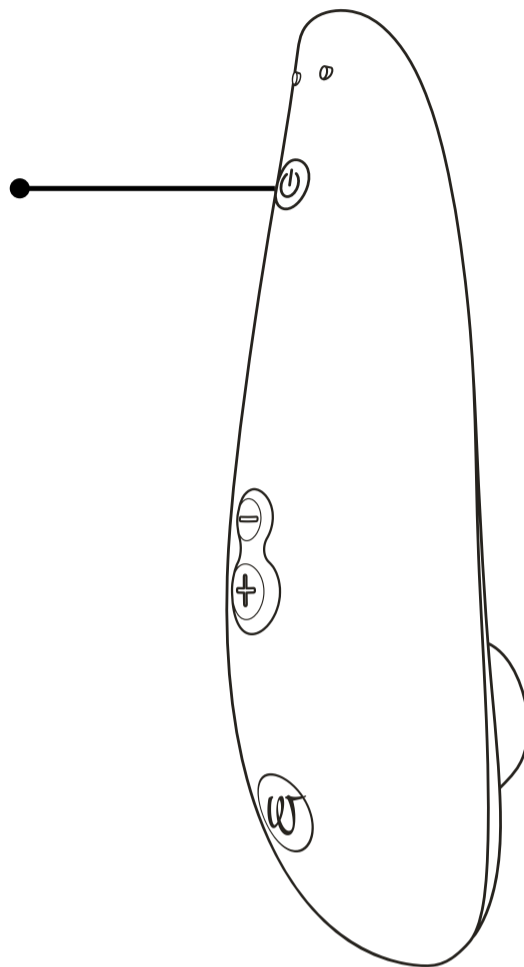

2. Anvendelse

Omgiv din klitoris med
stimuleringshovedet, og så
begynder din rejse.

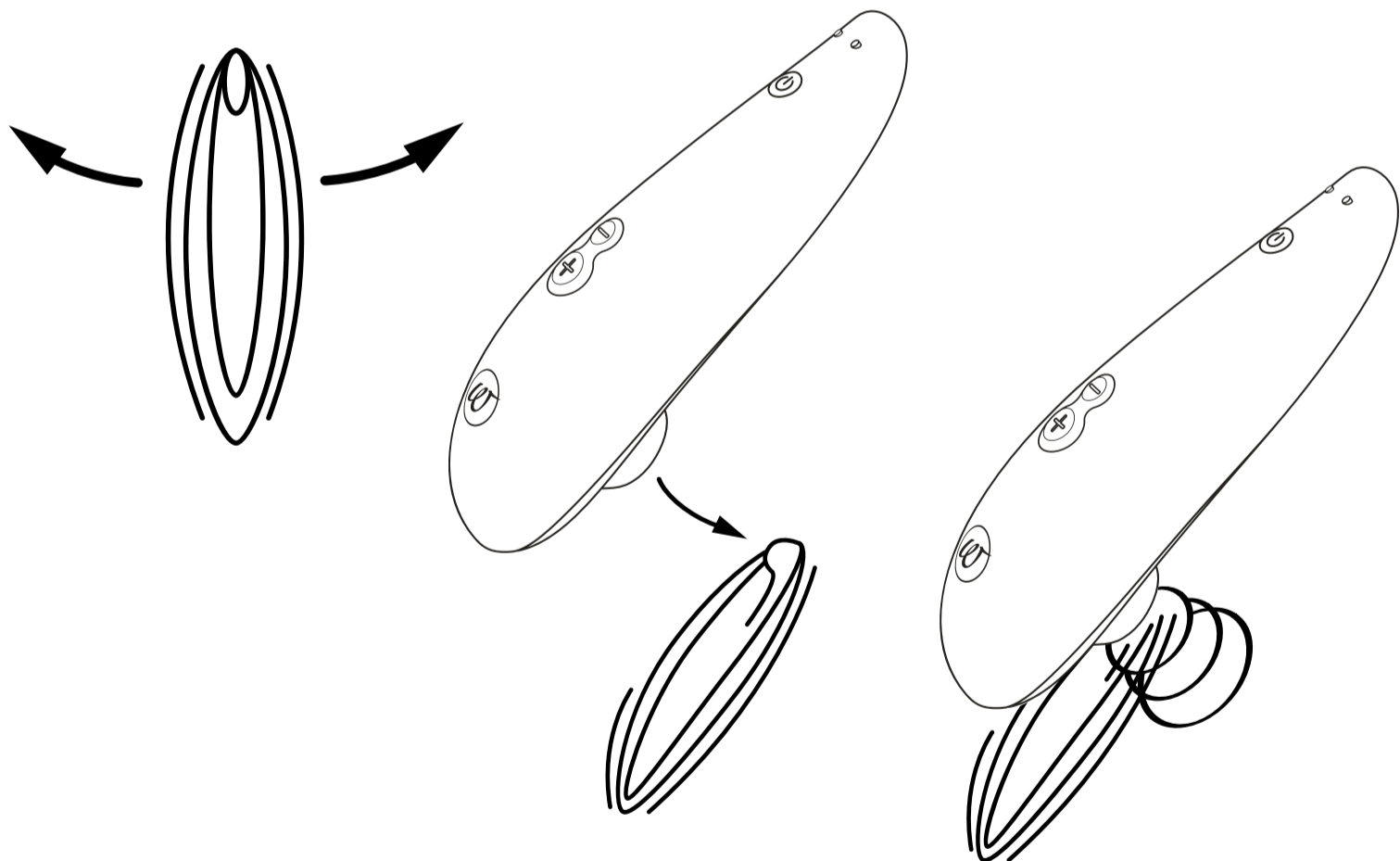

Et lille fif:

Hvis du mærker, at stimuleringstilbehøret endnu ikke har den optimale pasform, skifter du mellem de to stimuleringstilbehør (S eller M), der følger med enheden, for at skabe den bedste følelse for dig.

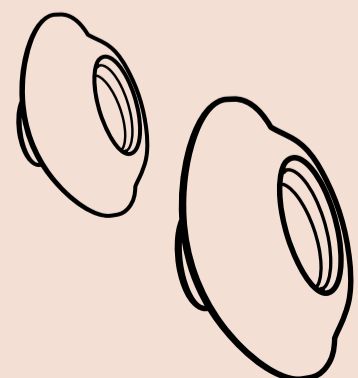

3. Skift styrke

Forøg tryk let

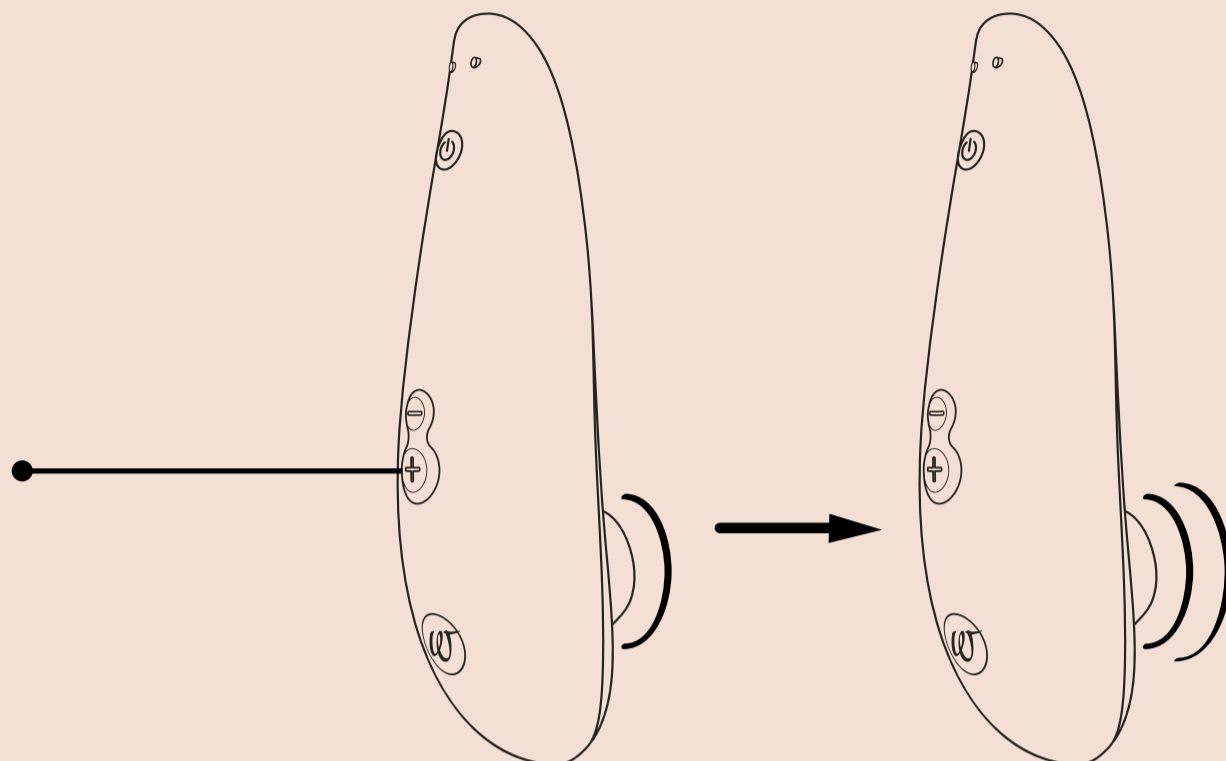

10 ⇄ Styrkeniveauer

Sænk tryk let

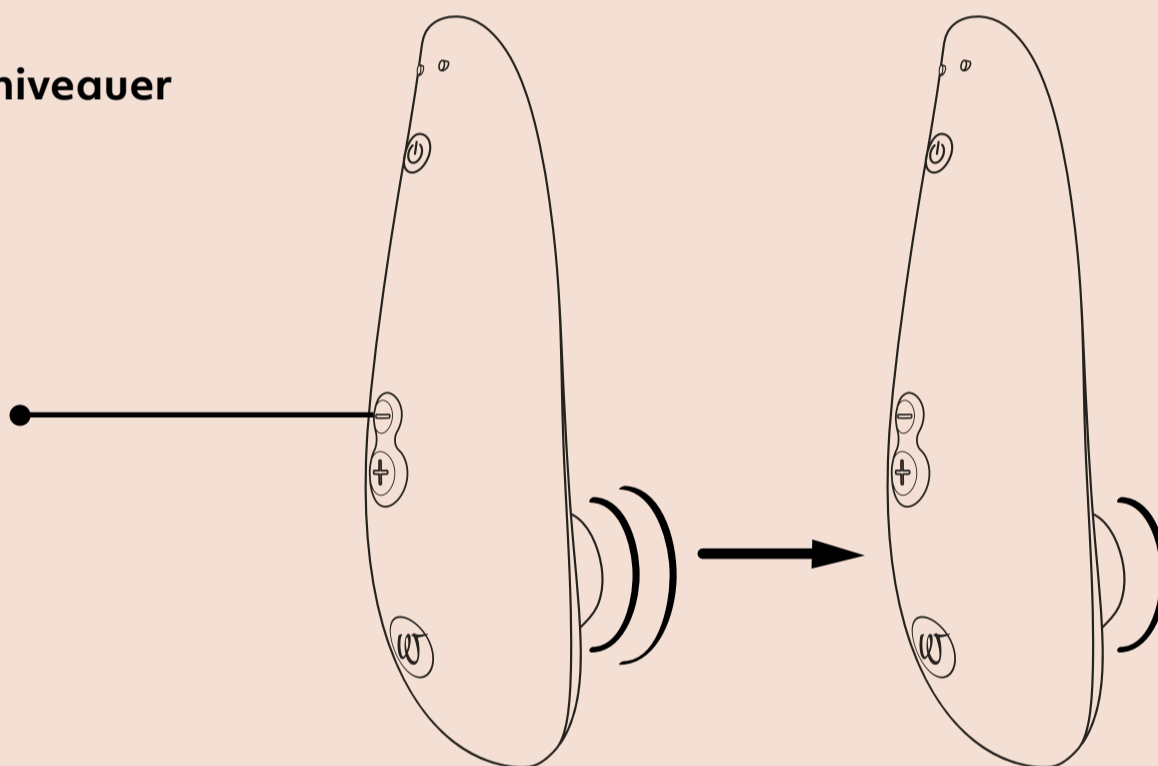

Afterglow-funktion: Tryk kort på tænd/sluk-knappen for at falde tilbage til styrkeniveau 1.

4. Sluk

Tryk i 2 sekunder

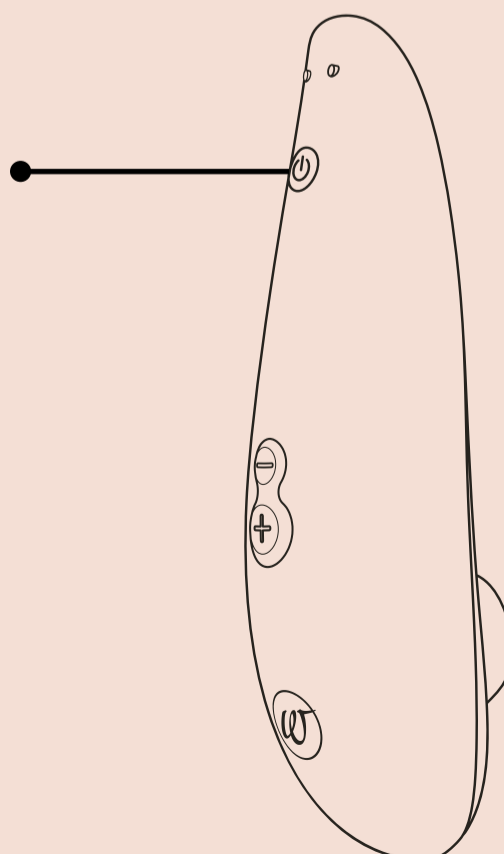

OPLADNING

Venligst oplad din Womanizer før første brug. Husk også at genoplade din Womanizer regelmæssigt for at sikre en lang batterilevetid.

Opladning via USB port

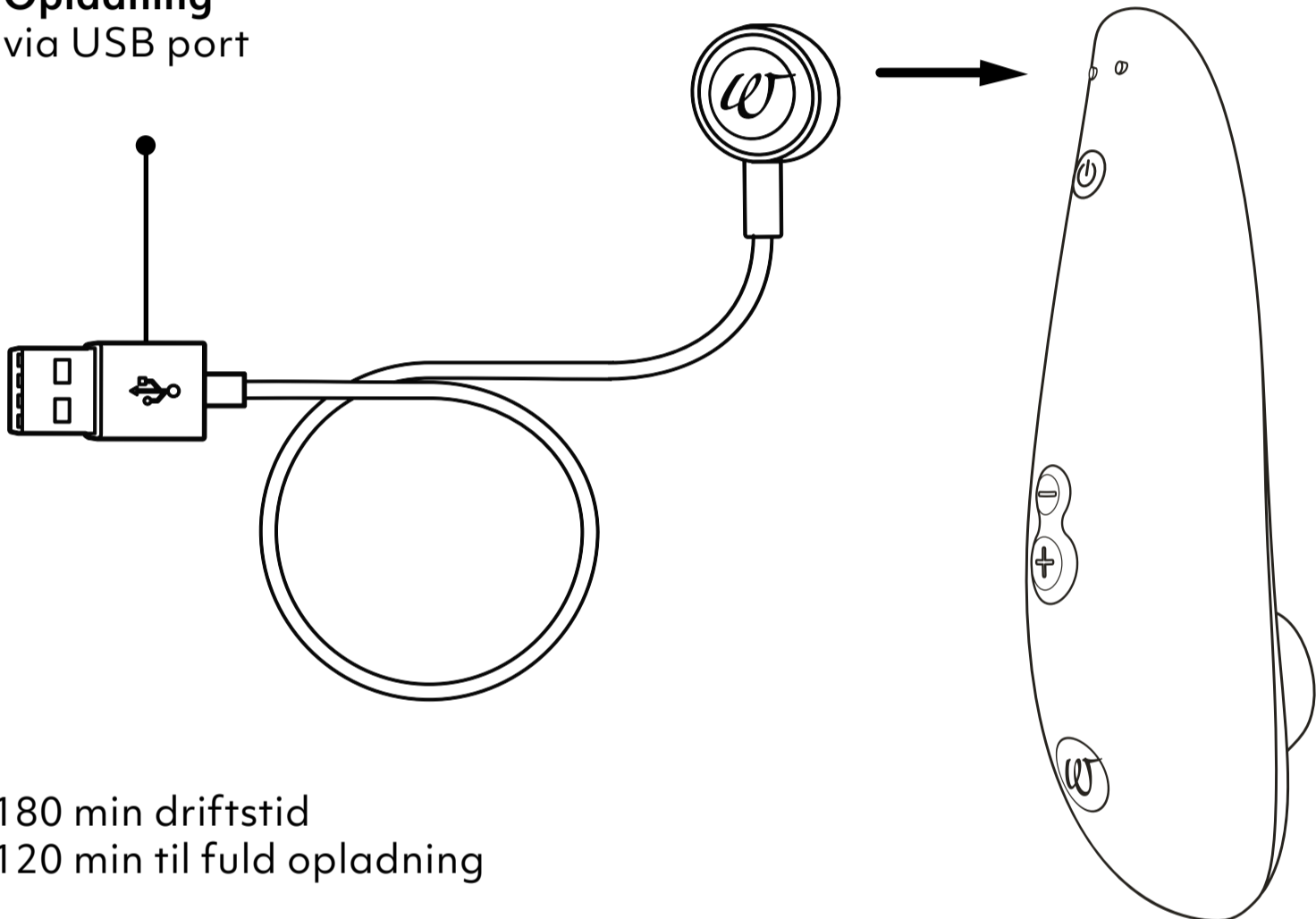

180 min driftstid
120 min til fuld opladning

LED Tænd/sluk-knap

Batteriniveau

Fuldt opladet

led lyser op konstant

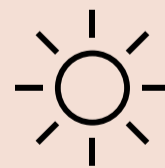

Halvt opladet

led blinker hurtigt

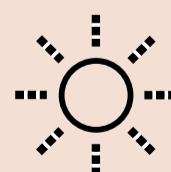

næsten afladet

led blinker langsomt

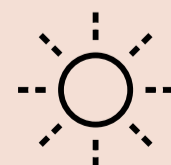

RENGØRING

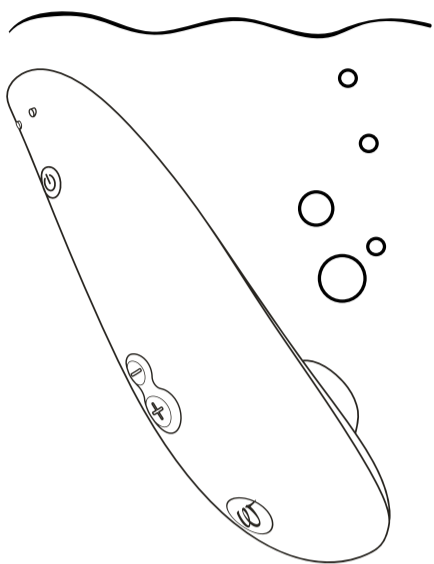

vask under vandet

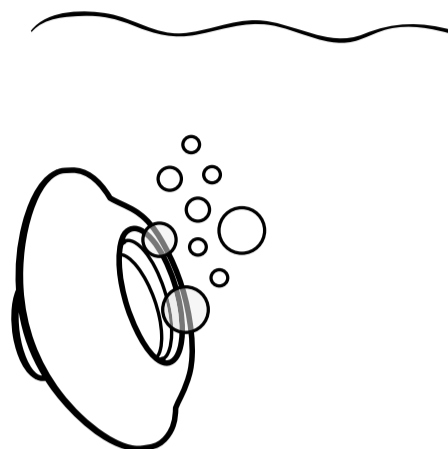

vask under vandet

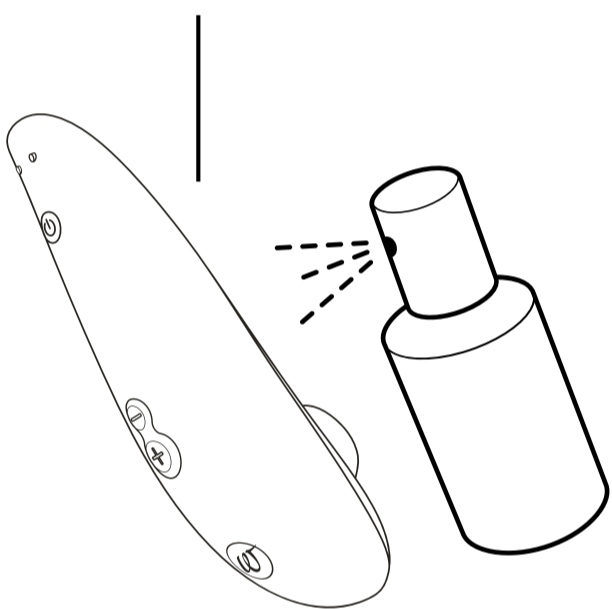

Brug legetøjsrens

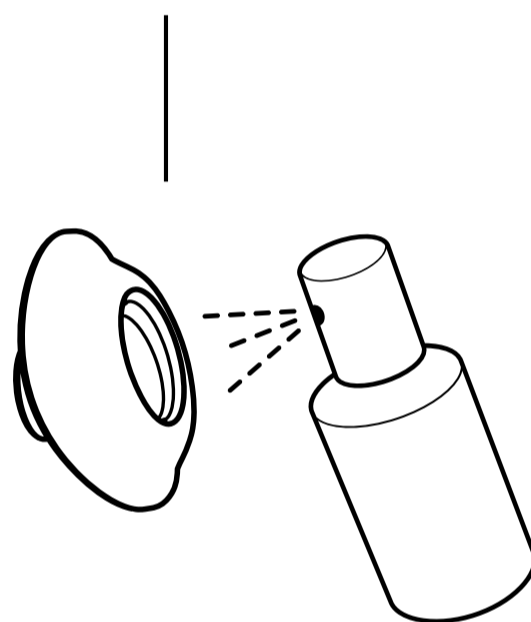

Brug legetøjsrens

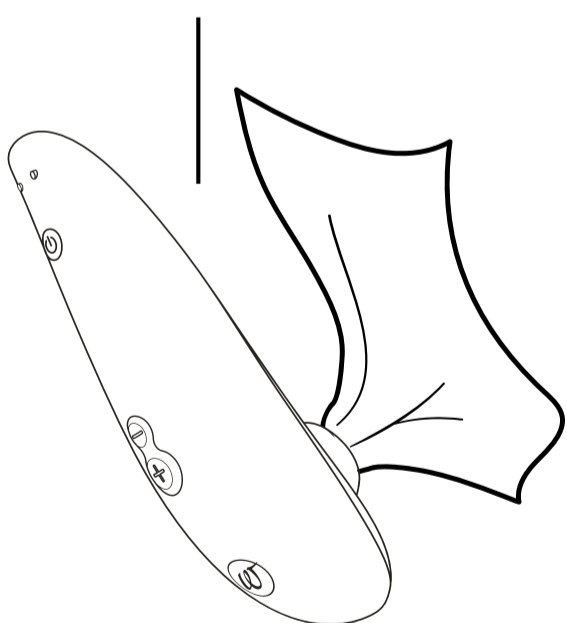

Tør

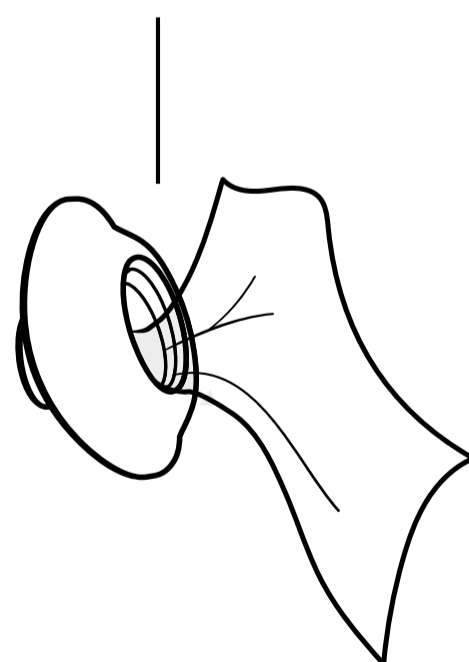

Tør



Waterproof
IPX7

GENEREL INFORMATION

ADVARSEL

Læs venligst sikkerhedsanvisningerne grundigt for yderligere information. Rengør din Womanizer grundigt inden første brug og efter hver brug for at reducere risikoen for infektion.

KUNDESERVICE

Få yderligere information ved at gå ind på vores hjemmeside www.womanizer.com, eller kontakt care@womanizer.com.

TEKNISKE SPECIFIKATIONER

Model: WZ08B

Nominel effekt: 100-240 V ~ 50/60 Hz

Udgang: 5 V $\overline{=}$ 0.75 A

Indeholder Li-ion genopladeligt batteri.

AC/DC-adapter ikke inkluderet.

LEVERINGSOMFANG

Womanizer Classic 2, USB-ladekabel, opbevaringspose af bomuld, 2 stimuleringshoveder, hurtigstartguide, sikkerhedsinstruktioner.

OPBEVARING

Opbevar enheden på et sikkert, tørt sted, hvor den ikke udsættes for direkte sollys.

GARANTI OG FRIVILLIG PRODU-CENTGARANTI

WOW TECH EUROPE GMBH tilbyder kunderne en frivillig producentgaranti til dette produkt ud over den lovmæssige garanti, som forbrugere har ret til fra forhandlerens side.

Betingelserne vedrørende den frivillige producentgaranti findes på vores hjemmeside under "Garantibetingelser".

OVERHOLDELSE AF STANDARDER

Dette apparat overholder alle standarder vedrørende elektromagnetisk kompatibilitet (EMC). Enheden er sikker at bruge, så længe den anvendes korrekt og i overensstemmelse med anvisningerne i denne brugermanual.

BESKYTTELSE AF MILJØET

Som distributør af elektroniske en-

heder er vi juridisk forpligtet til at acceptere returnering af affald af elektriske og elektroniske enheder gratis. Vi erklærer udtrykkeligt, at du som bruger er juridisk forpligtet til at returnere brugte batterier. Smid aldrig elektronisk udstyr eller batterier ud med husholdningsaffaldet.

Nedenstående symbol, der også findes på vores elektroniske genstande, har til formål at minde dig om dette.

PRODUCENT

WOW Tech Europe GmbH,
Friedenstrasse 91 / 91 a, 10249 Berlin, Tyskland

WOW Tech Europe GmbH forbeholder sig ret til at foretage tekniske ændringer og ændringer i designet med det formål at forbedre enheden.

Distribueret i Nordamerika af WOW TECH Canada Ltd. 1545 Carling Avenue, Suite 401, Ottawa ON, Canada K1Z 8P9

www.wowtech.com Designet i Tyskland. Fremstillet i Kina i 2021. Manual udstedet i 02/2021. Version 1.

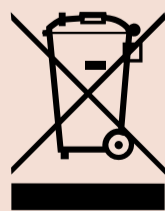

VIL DU HAVE MERE?

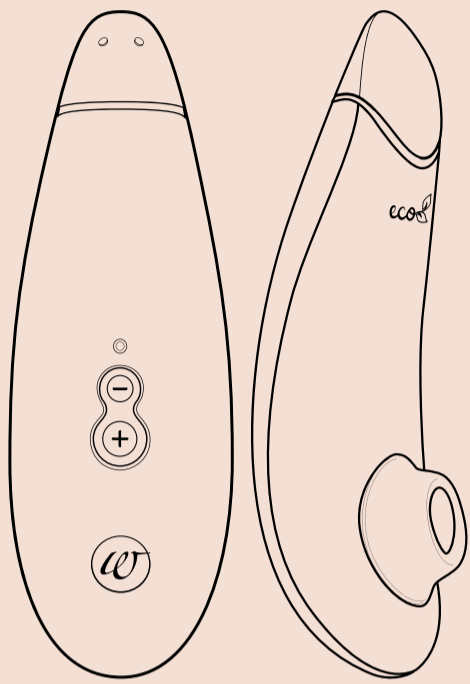

**Pleasure Air
Technology**



Smart Silence



Eco-friendly

Premium eco 

Loving Our Planet Can Be Orgasmic

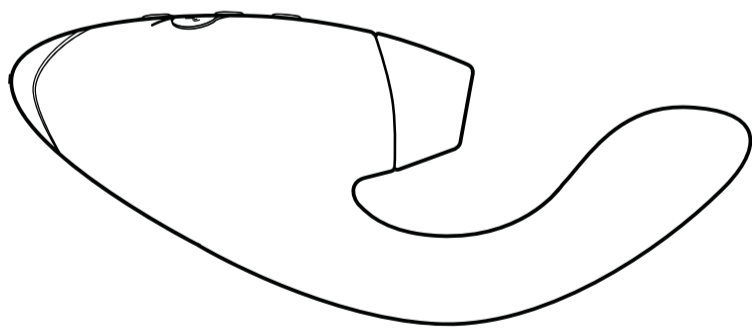

**Pleasure Air
Technology**



Vibrator



Smart Silence

DUO

Double your Pleasure



#IMASTURBATE

Hei!

Takk for at du valgte Womanizer!

Velkommen til en verden full av sensuelle opplevelser som vil berike livet ditt. Ved å velge WOMANIZER er du ikke bare garantert orgasmer som er uten sammenligning – men også et nytt begjær til pur glede.

Kos deg med WOMANIZER – få den ene orgasmen etter den andre.

Start nå, elsk deg selv!



PRODUKTBESKRIVELSE

HVORDAN BRUKE DEN

LADING

RENGJØRING

GENERELL INFORMASJON

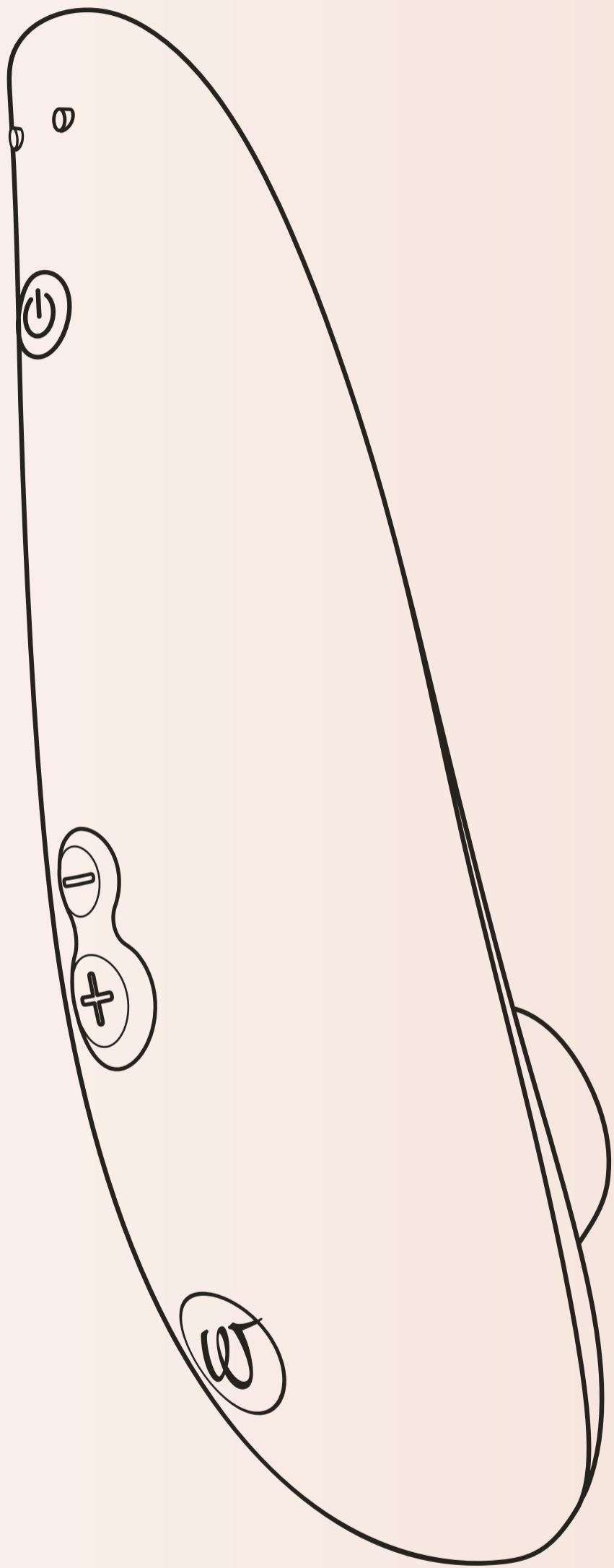

PRODUKTBESKRIVELSE

**Magnetiske
ladepins**

På/Av
trykk i 2 sekunder

Afterglow Feature
trykk kort

Reduser intensiteten
trykk kort

Øk intensiteten
trykk kort

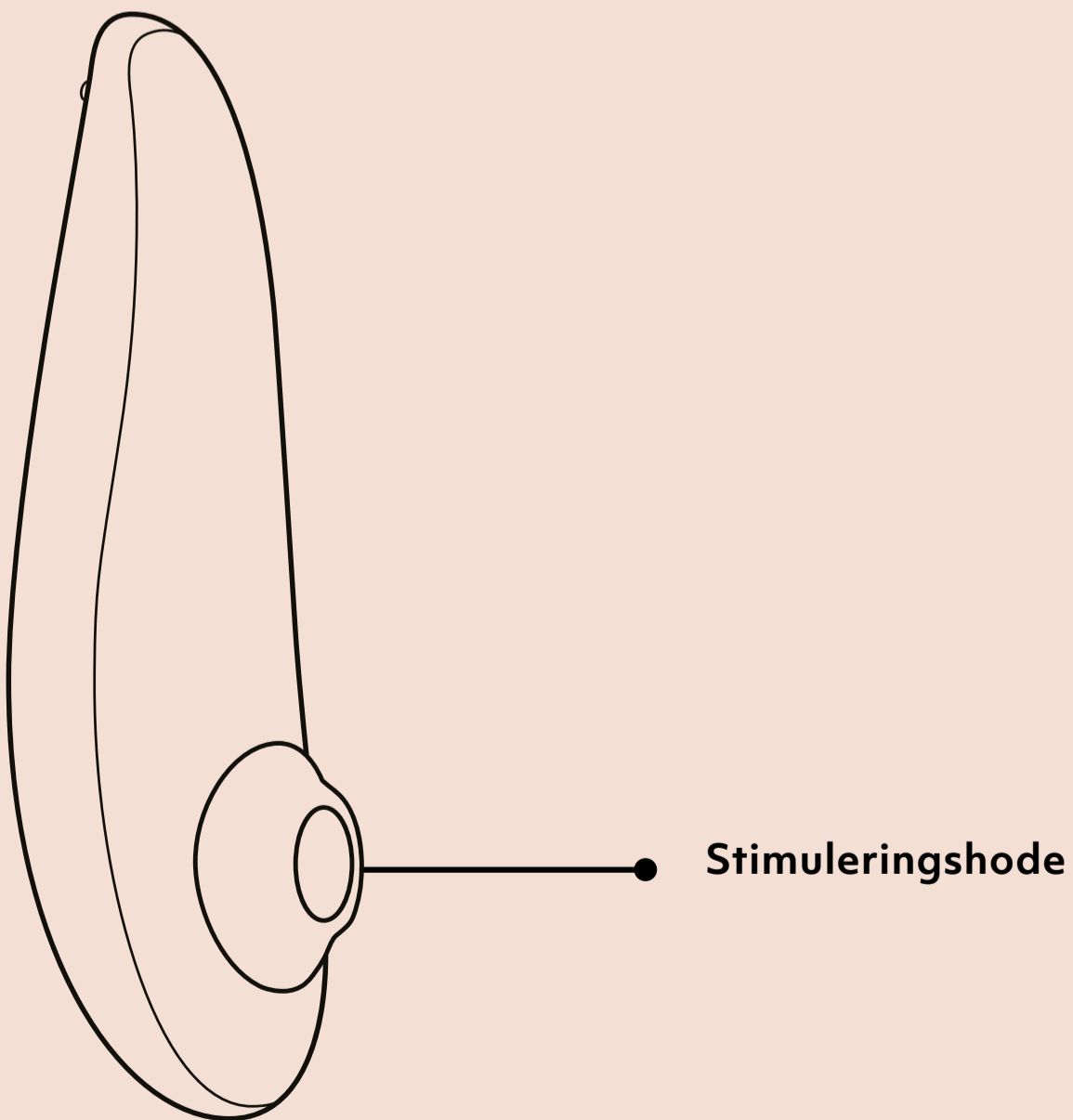
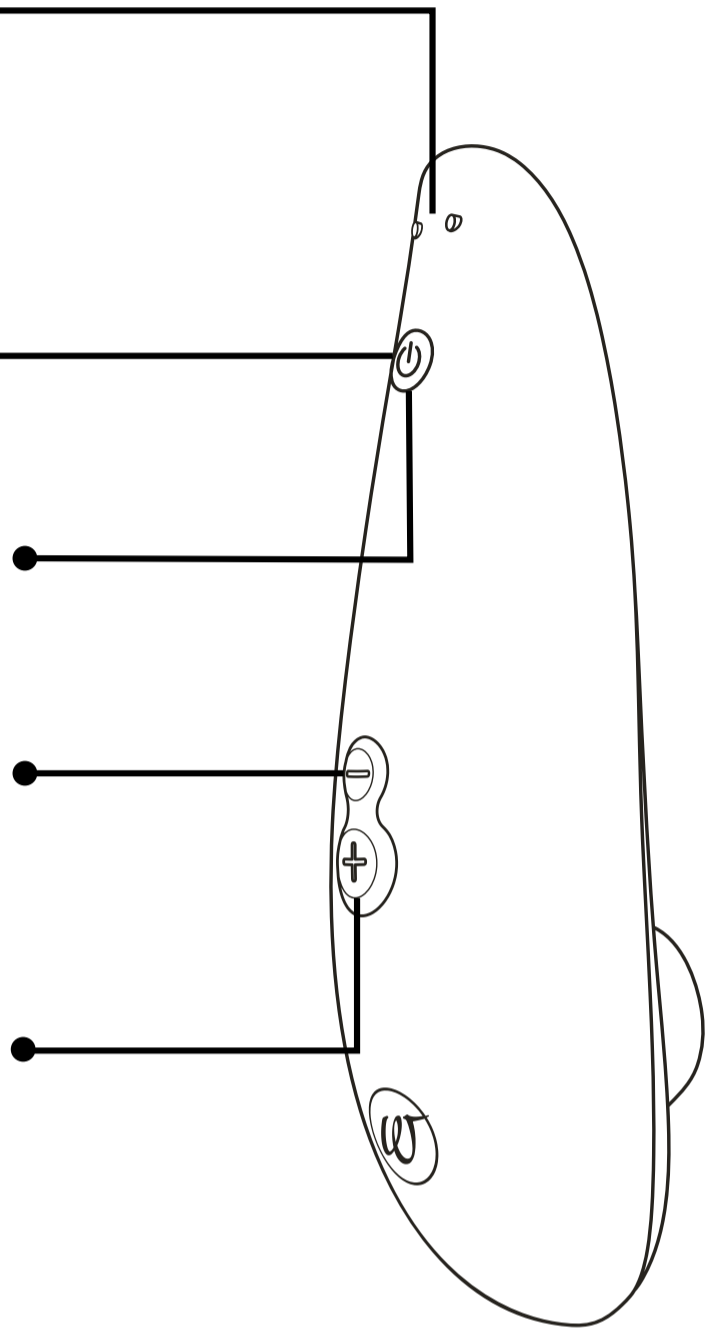

HVORDAN BRUKE DEN

1. Slå på

Trykk i
2 sekunder

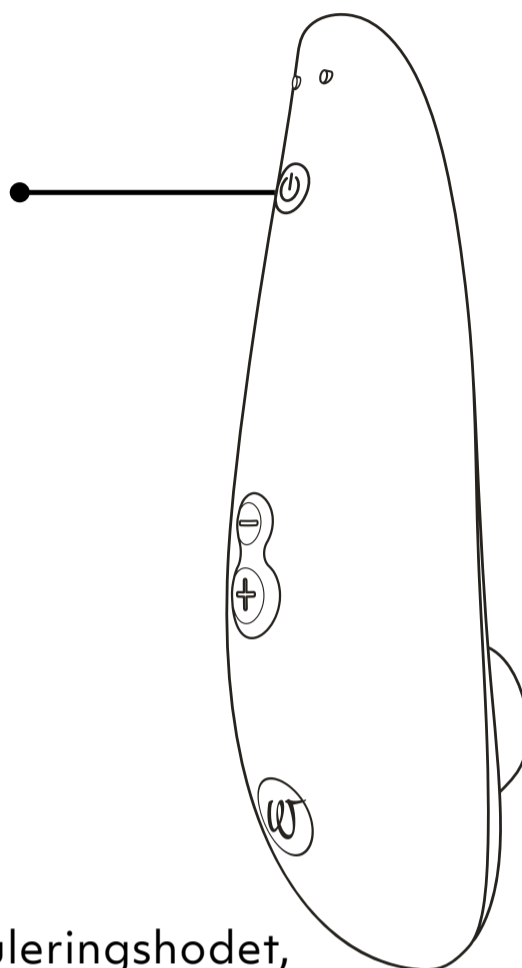

2. Bruk

Omfavne klitoris med stimuleringshodet, og la eventyret begynne.

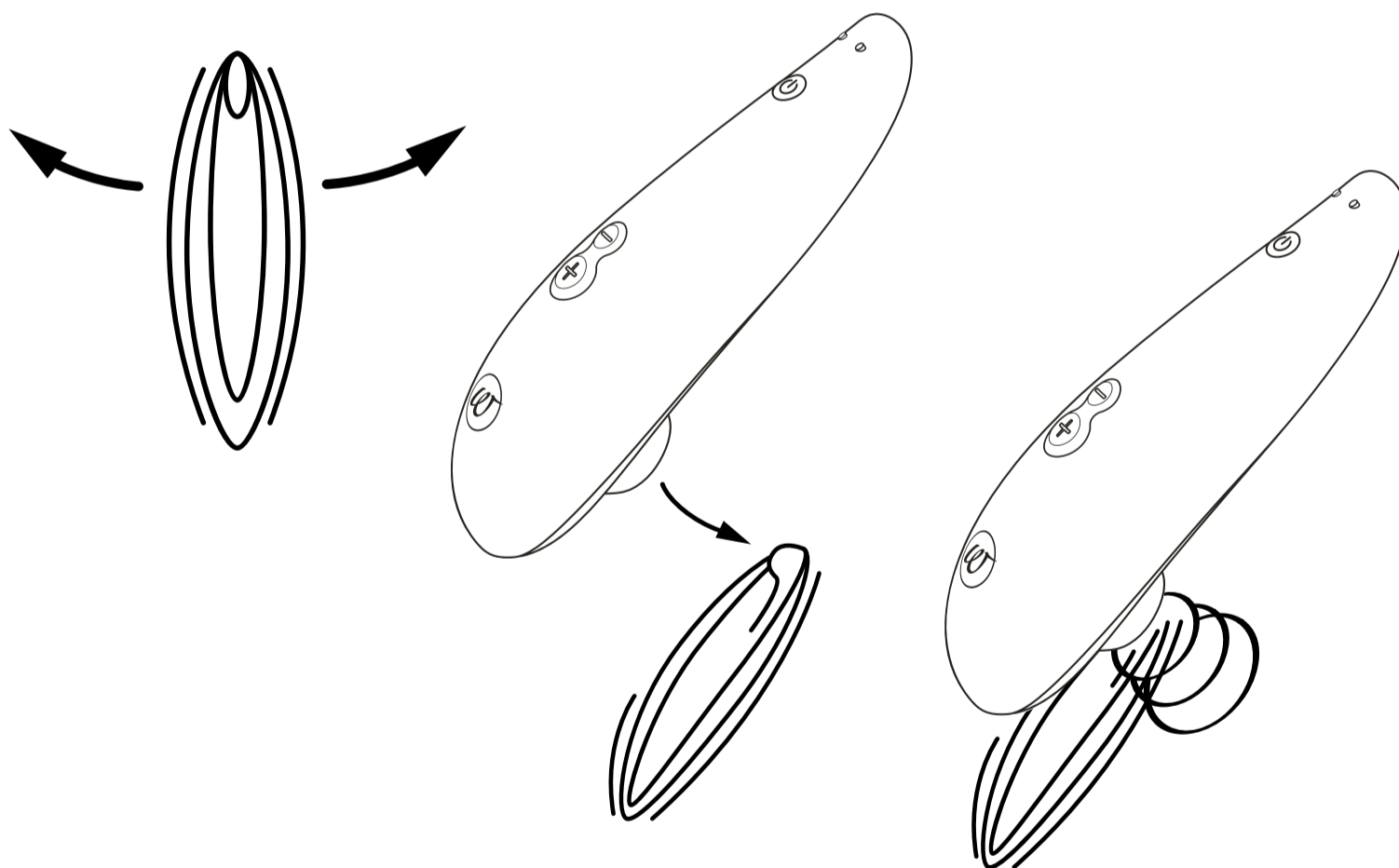

Et lite tips

Hvis du merker at stimulerings-vedlegget ikke har den optimale passformen ennå, bytter du mellom de to stimulerings-vedleggene (S eller M) som følger med enheten for å skape den beste følelsen for deg.

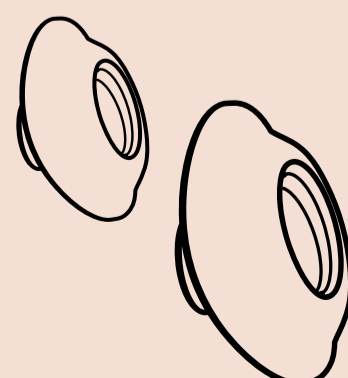

3. Endre intensitet

Øk intensiteten
trykk kort

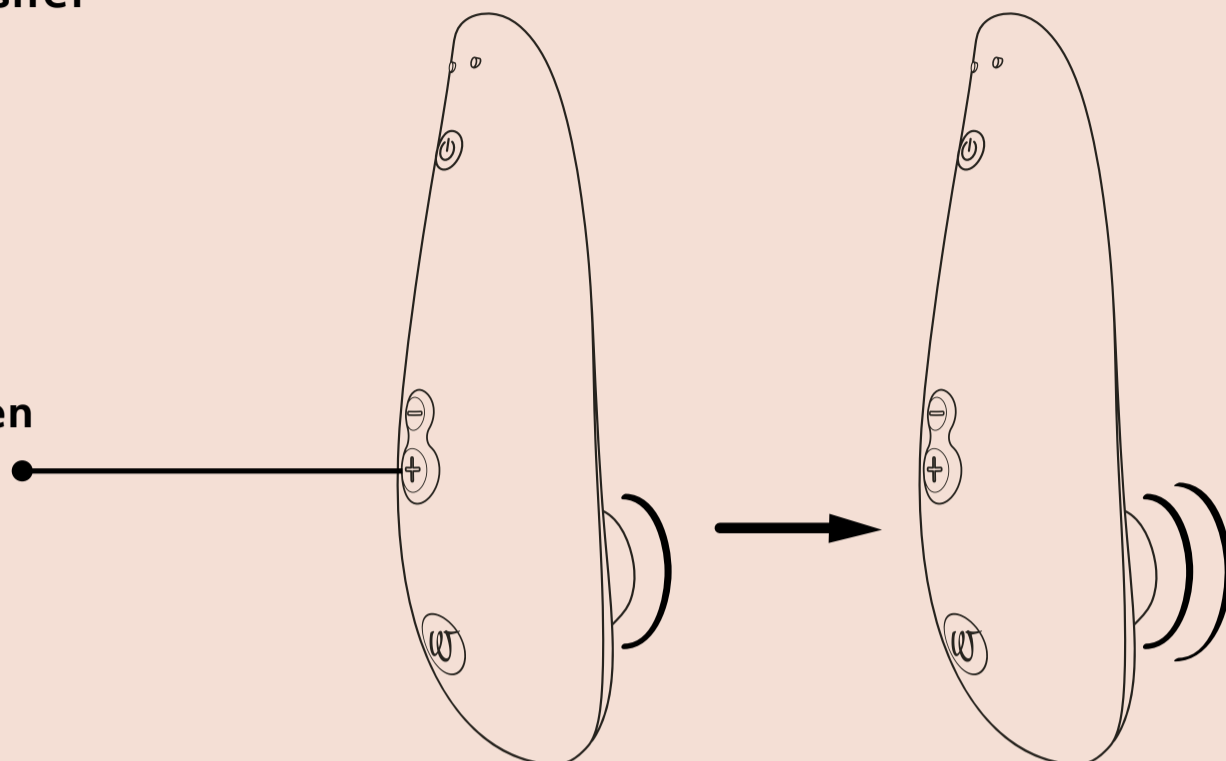

10  Intensitetsnivåer

Avta
trykk kort

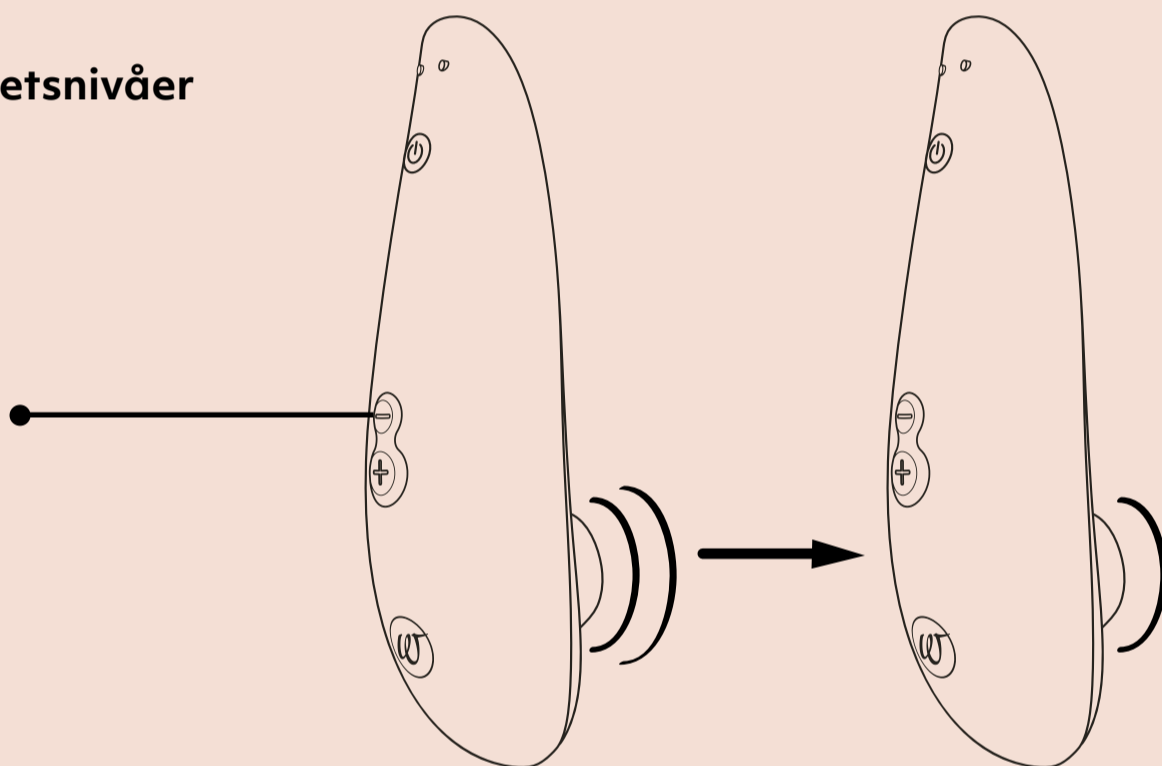

Afterglow Feature: Trykk kort på av-/på-knappen for å komme tilbake til intensitetsnivå 1.

4. Slå av

Trykk i
2 sekunder

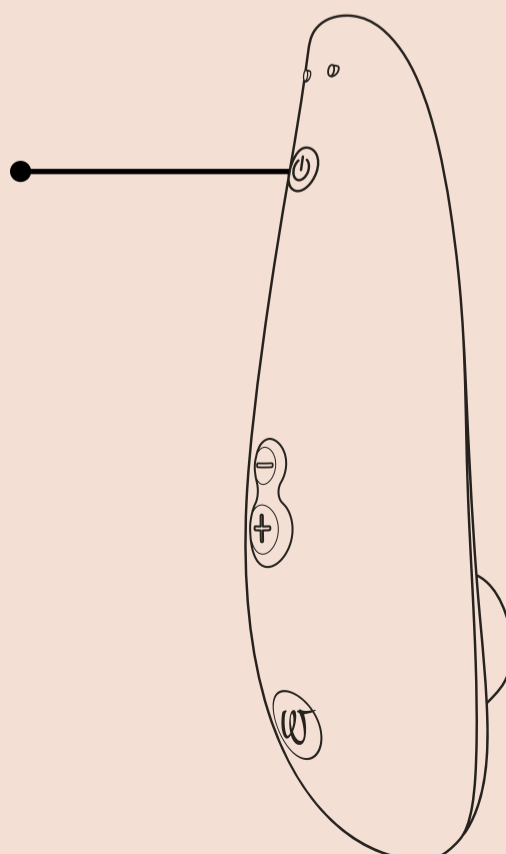

LADING

Lad Womanizer før første gangs bruk. Husk også å lade Womanizer regelmessig for å sikre lang batterilevetid.

Lading via USB-port

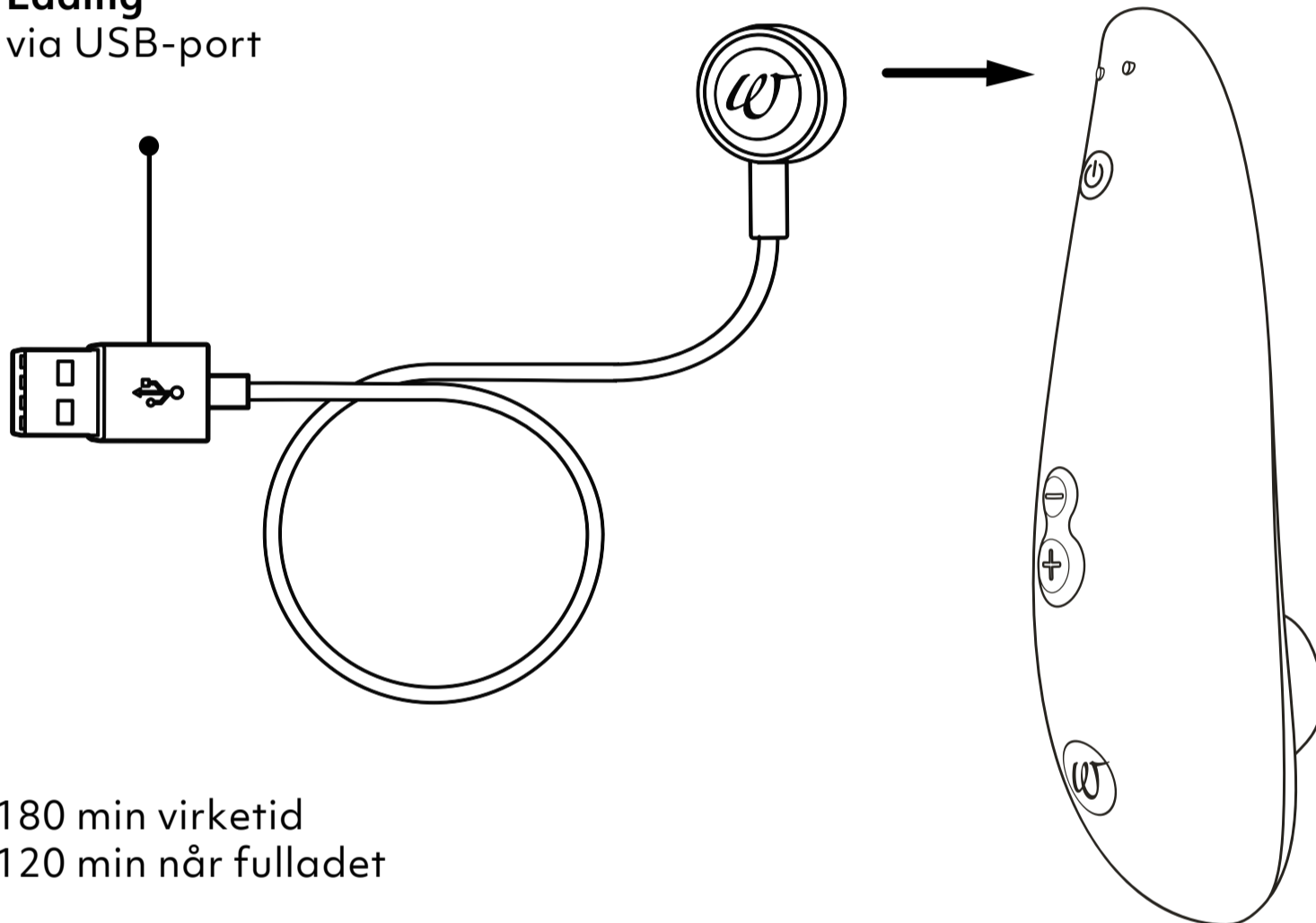

180 min virketid
120 min når fulladet

LED power-knapp Batterinivå

Fulladet
LED lyser kontinuerlig

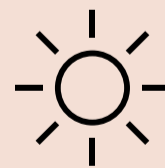

Halvt ladet
ledlyset blinker raskt

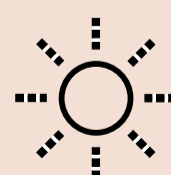

nesten utladet
led blinker sakte

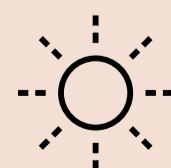

RENGJØRING

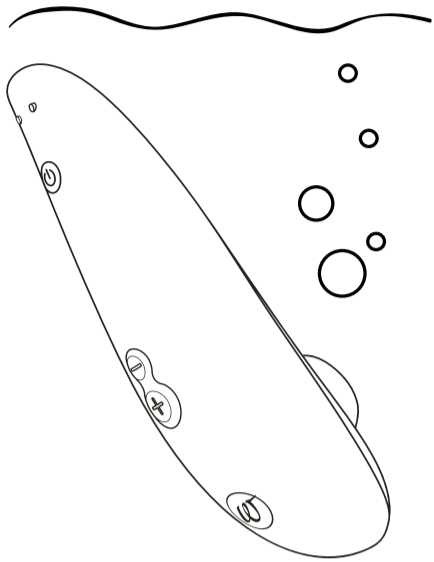

vaskes under vann

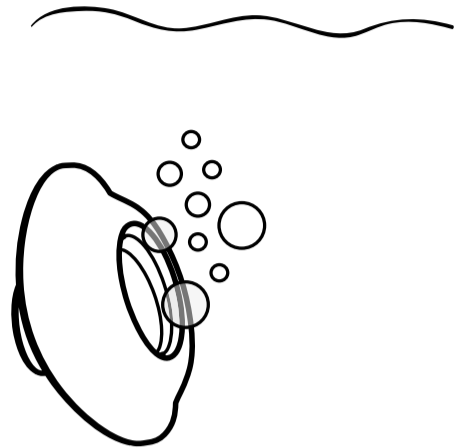

vaskes under vann

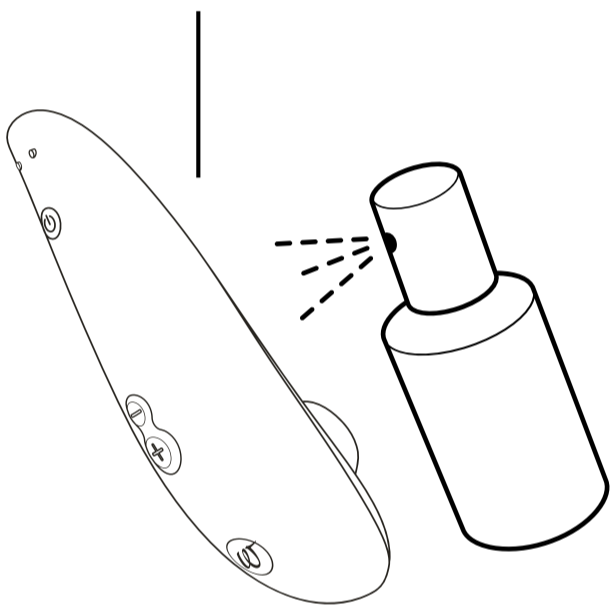

Påfør toy-cleaner

+

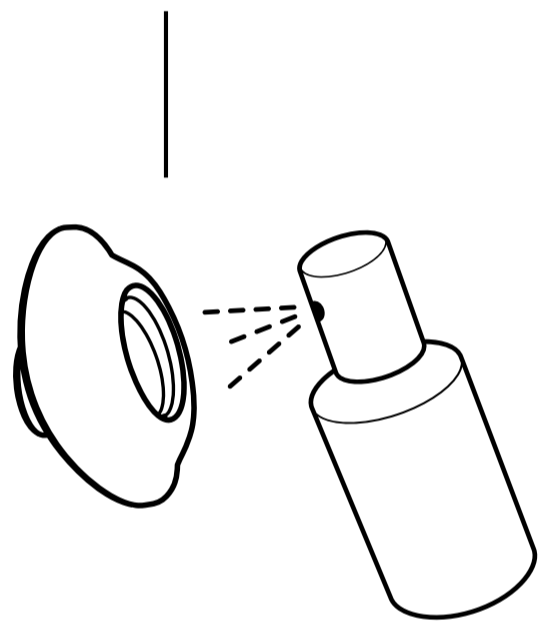

Påfør toy-cleaner

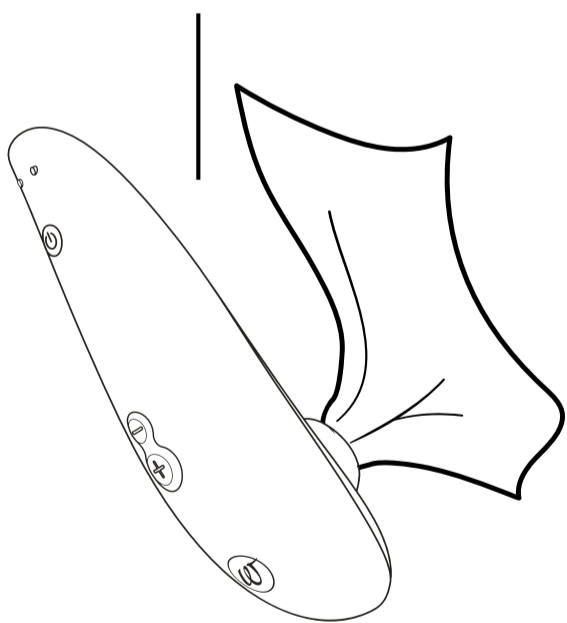

Tørke

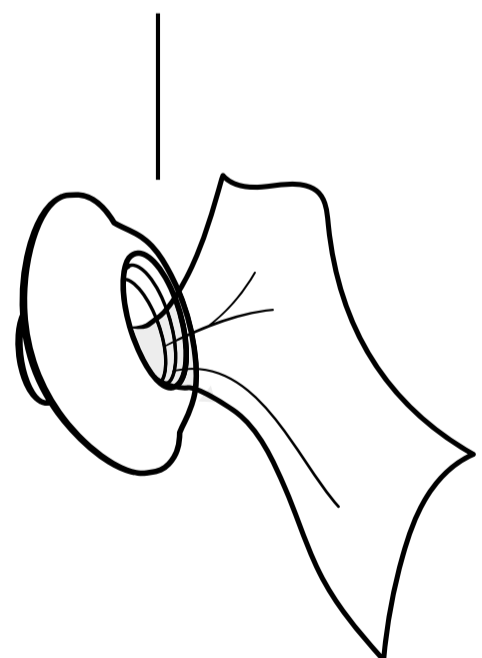

Tørke



Waterproof
IPX7

GENERELL INFORMASJON

ADVARSEL

Les sikkerhetsinstruksjonene nøye for mer informasjon.

Rengjør Womanizer grundig før du bruker den for første gang og etter hver bruk for å redusere risikoen for infeksjon.

KUNDESERVICE

For mer informasjon, besøk vår nettside www.womanizer.com eller kontakt care@womanizer.com.

TEKNISKE SPESIFIKASJONER

Modell: WZ08B

Effekt: 100-240 V ~ 50/60 Hz

Utgang: 5 V $\overline{=}$ 0.75 A

Inneholder oppladbart Li-ion-batteri.
AC / DC adapter ikke inkludert.

INNHold I LEVERANSEN

Womanizer Classic 2, USB-ladekabel, oppbevaringspose av bomull, 2 stimuleringshoder, hurtigstartguide, sikkerhetsinstruksjoner.

OPPBEVARING

Oppbevares på et sikkert, tørt sted uten direkte sollys.

GARANTI OG FRIVILLIG PRODUS- ENTGARANTI

WOW TECH EUROPE GMBH tilbyr kundene en frivillig produsentgaranti for dette produktet i tillegg til den lovpålagte garantien som forbrukerne har krav på med hensyn til selgere. Betingelsene med hensyn til den frivillige produsentens garanti finner du på nettstedet vårt under „Garantibetingelser“.

OPPFYLLING AV STANDARDER

Dette apparatet oppfyller alle standarder angående elektromagnetisk kompatibilitet (EMC). Enheten er sikker å bruke så lenge den brukes riktig og i samsvar med instruksjonene gitt i denne brukerhåndboken.

MILJØVERN

Som distributør av elektroniske enheter er vi juridisk forpliktet til å akseptere retur av avfall av elektriske

og elektroniske apparater gratis. Vi gir uttrykkelig opplysning om at du som bruker er juridisk forpliktet til å returnere brukte batterier. Kast aldri elektroniske enheter eller batterier i husholdningsavfallet.

Symbolet vist nedenfor, som også er festet til våre elektroniske gjenstander, er ment å uttrykke en påminnelse om dette.

PRODUSENT

WOW Tech Europe GmbH,
Friedenstrasse 91 / 91 a, 10249 Berlin, Germany

WOW Tech Europe GmbH forbeholder seg retten til å gjøre tekniske endringer og endringer i designet som kan forbedre enheten.

Distribuert i Nord-Amerika av WOW TECH Canada Ltd. 1545 Carling Avenue, Suite 401, Ottawa ON, Canada K1Z 8P9

www.wowtech.com Designet i Tyskland. Laget i Kina i 2021. Manual utstedt 02/2021. Versjon 1.

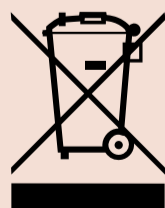

ØNSKER DU MER?

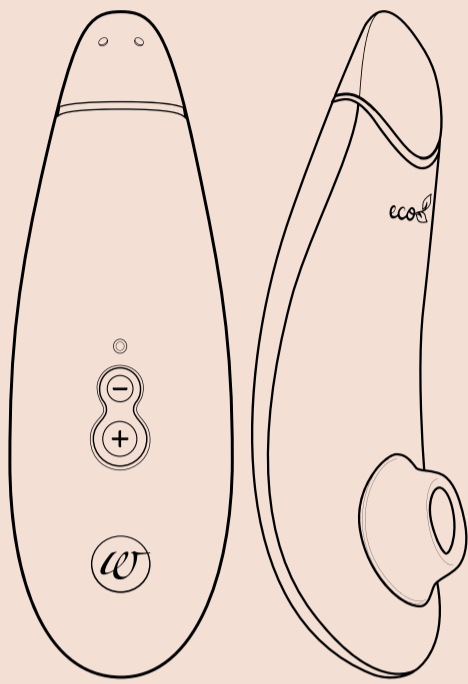

**Pleasure Air
Technology**



Smart Silence



Eco-friendly

Premium eco 

Loving Our Planet Can Be Orgasmic

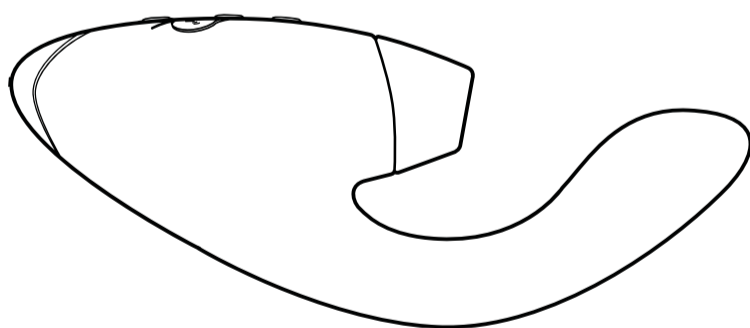

**Pleasure Air
Technology**



Vibrator



Smart Silence

DUO

Double your Pleasure



#IMASTURBATE

嗨！

感谢您选择 Womanizer!

欢迎探索快感迭起的情趣世界,生活从此更加丰富多彩。选择 WOMANIZER,您不仅可以享受无与伦比的美好高潮,还能拥有全新的欢愉欲望。

享受 WOMANIZER - 带给您一次又一次的高潮

好好爱自己!



产品说明
如何使用
充电
清洁
一般信息

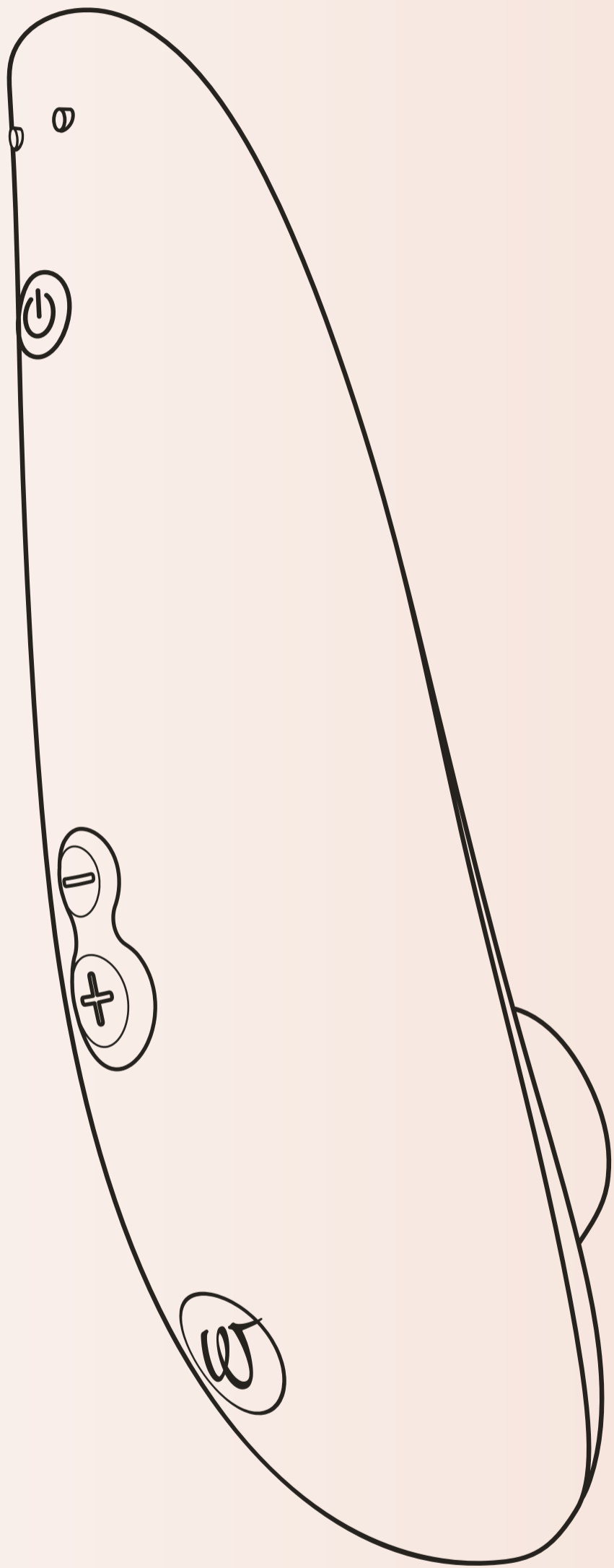

产品说明

磁吸充电头

开启/关闭
按压 2 秒

Afterglow 餘韻功能
短按

降低强度
短按

增加强度
短按

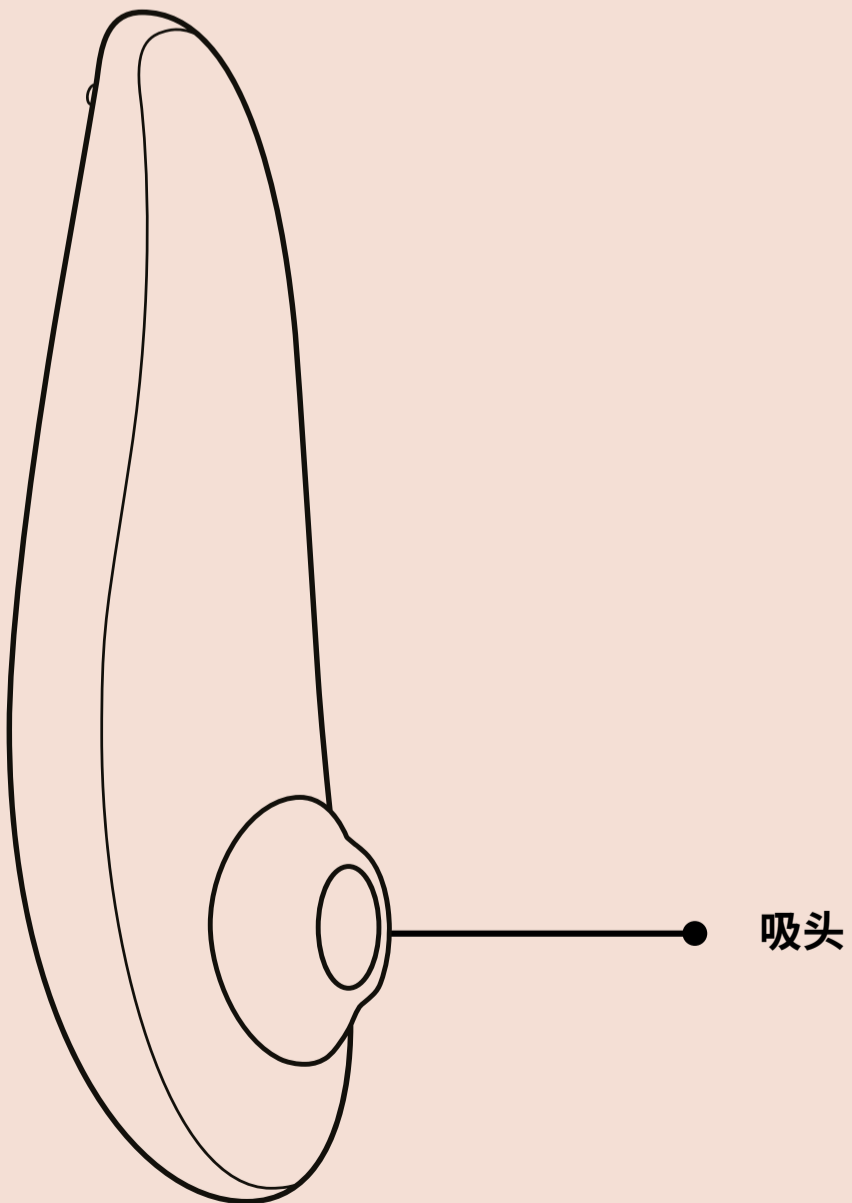
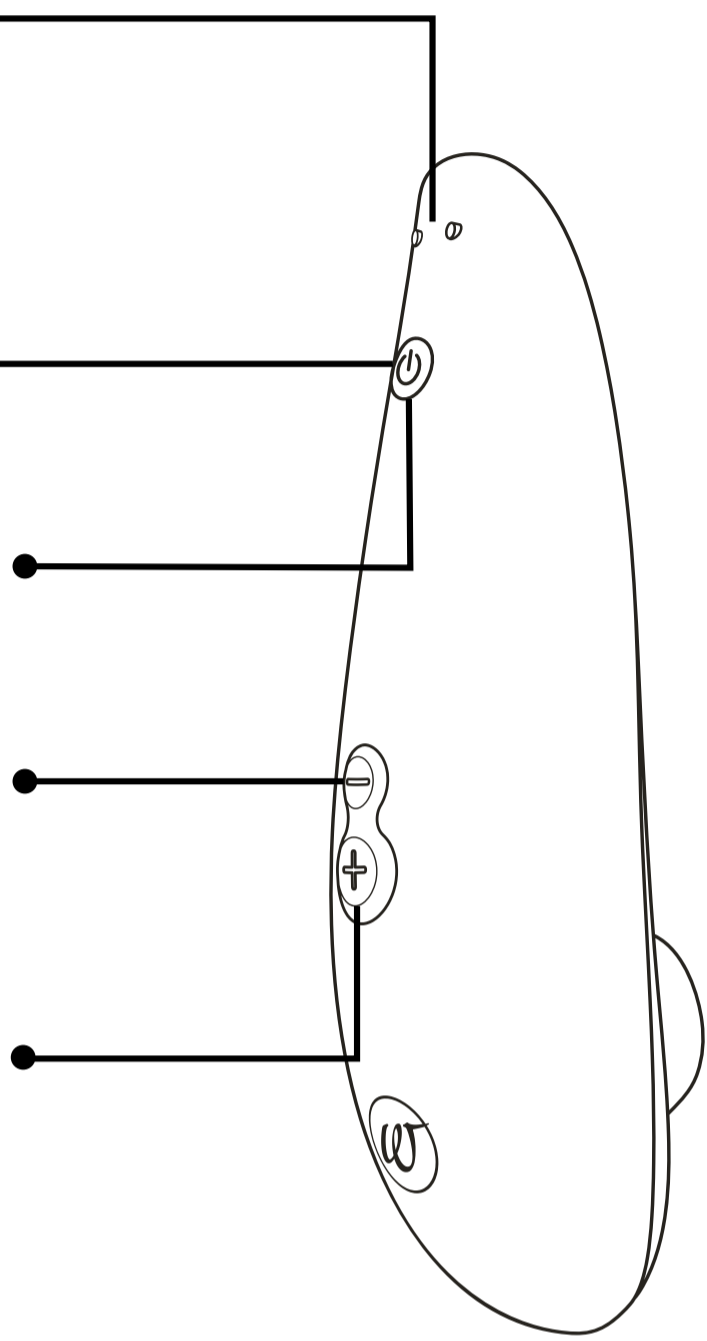

如何使用

1. 开启电源

按压
2 秒

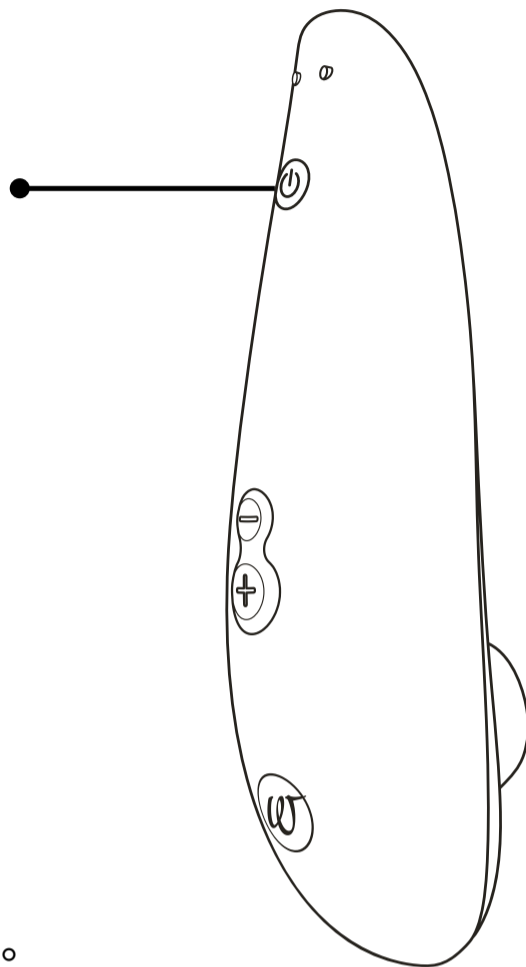

2. 使用方法

用吸咀包围阴蒂, 开启享受之旅。

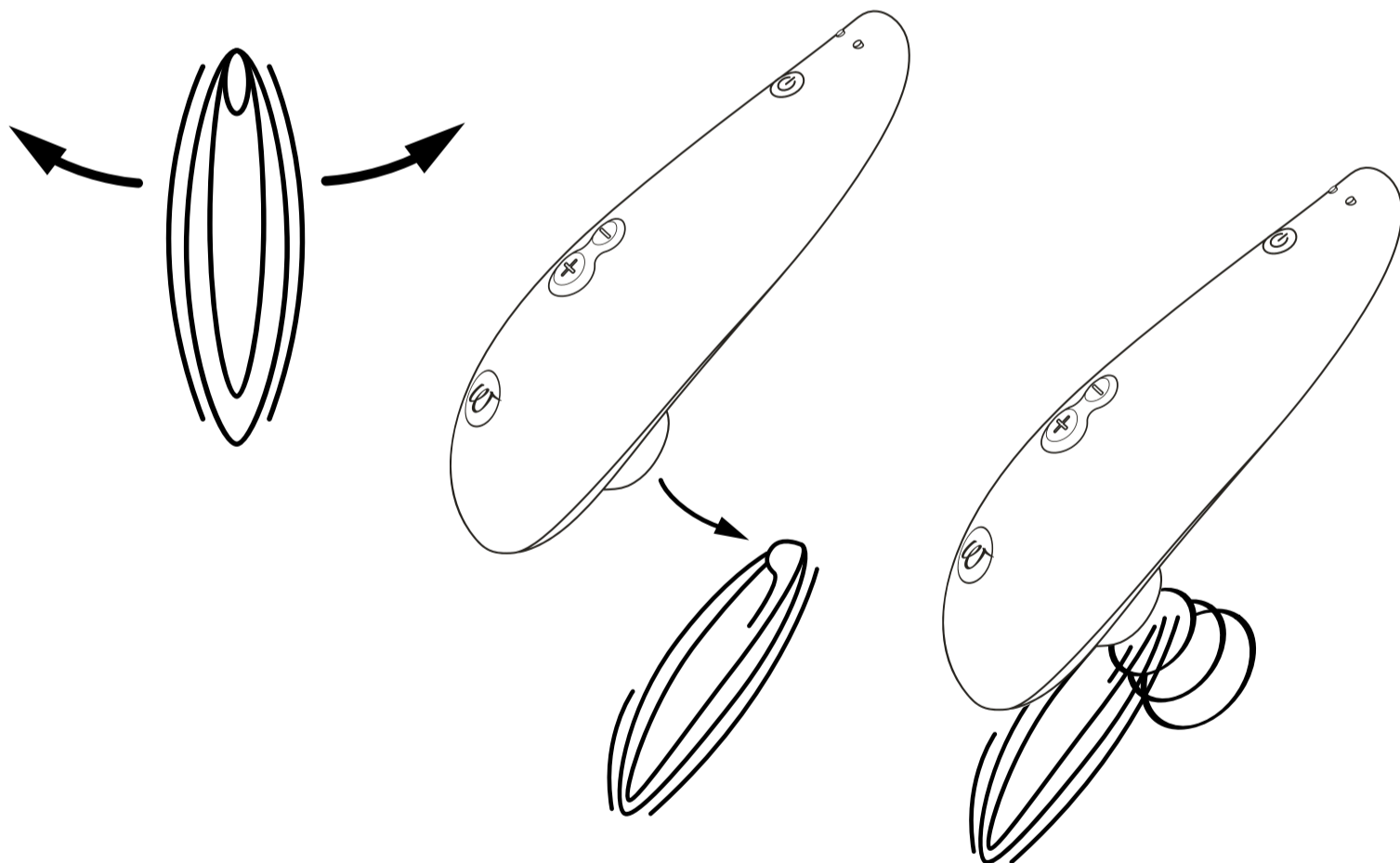

小提示:

如果您发现按摩器吸头未最佳贴合, 请选择随设备一起提供的两个吸头 (S 或 M) 进行替换, 为您创造最佳体验。

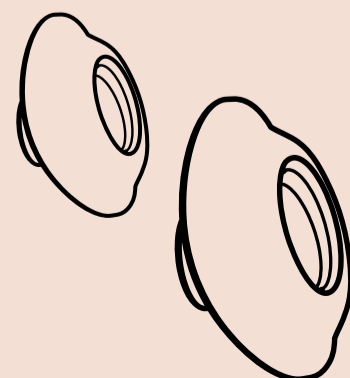

3. 改变强度

增加
短按

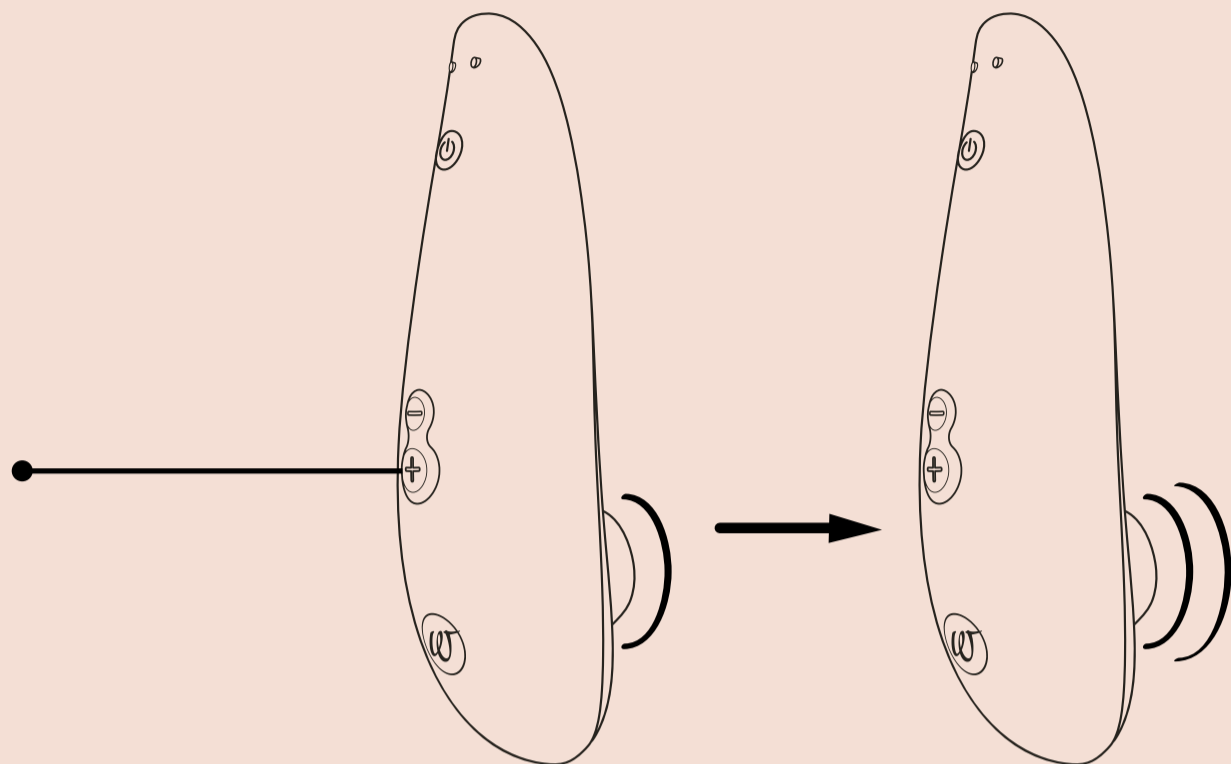

10  强度选择

降低
短按

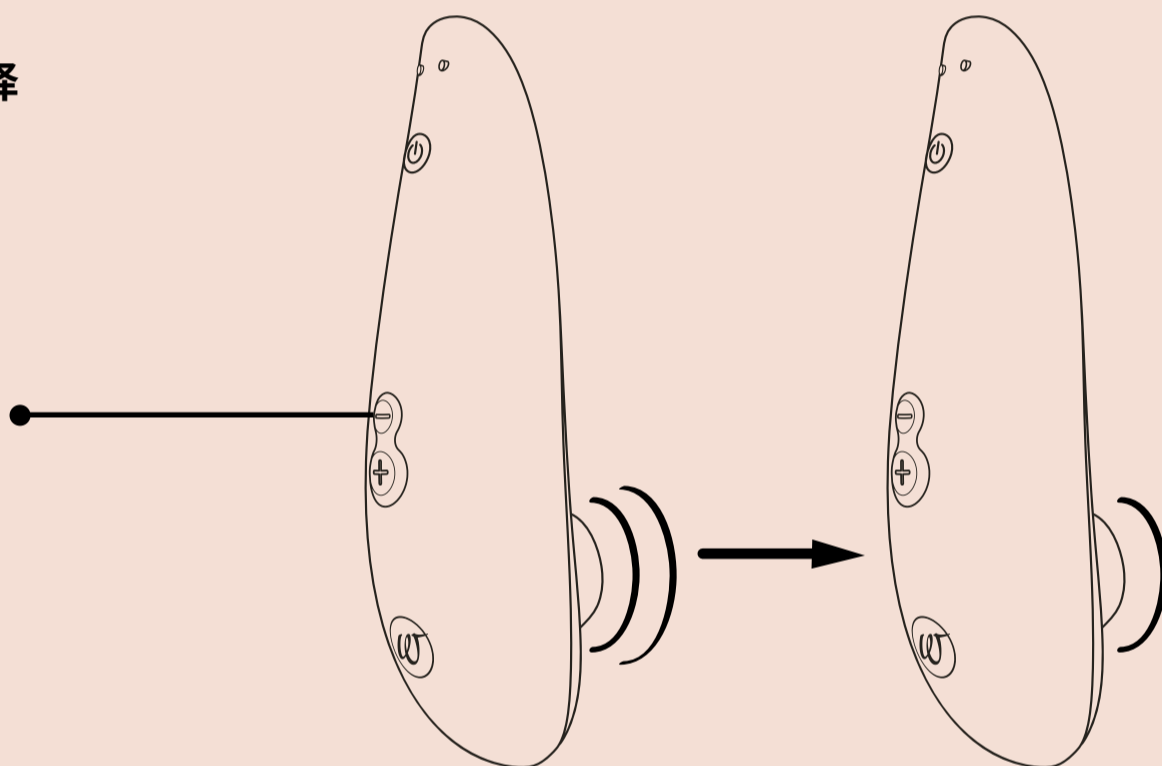

Afterglow 餘韻功能：短按電源按鈕可返回強度等級 1。

4. 关闭

按压
2 秒

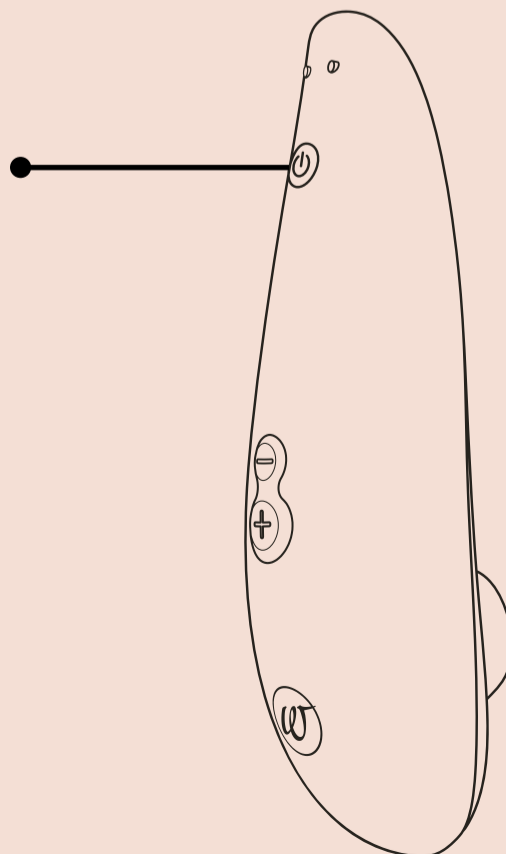

充电

请在首次使用前为您的 Womanizer 充电。同时也请记住应定期为 Womanizer 充电, 确保电池能保有较长寿命。

充电
通过 USB 接口

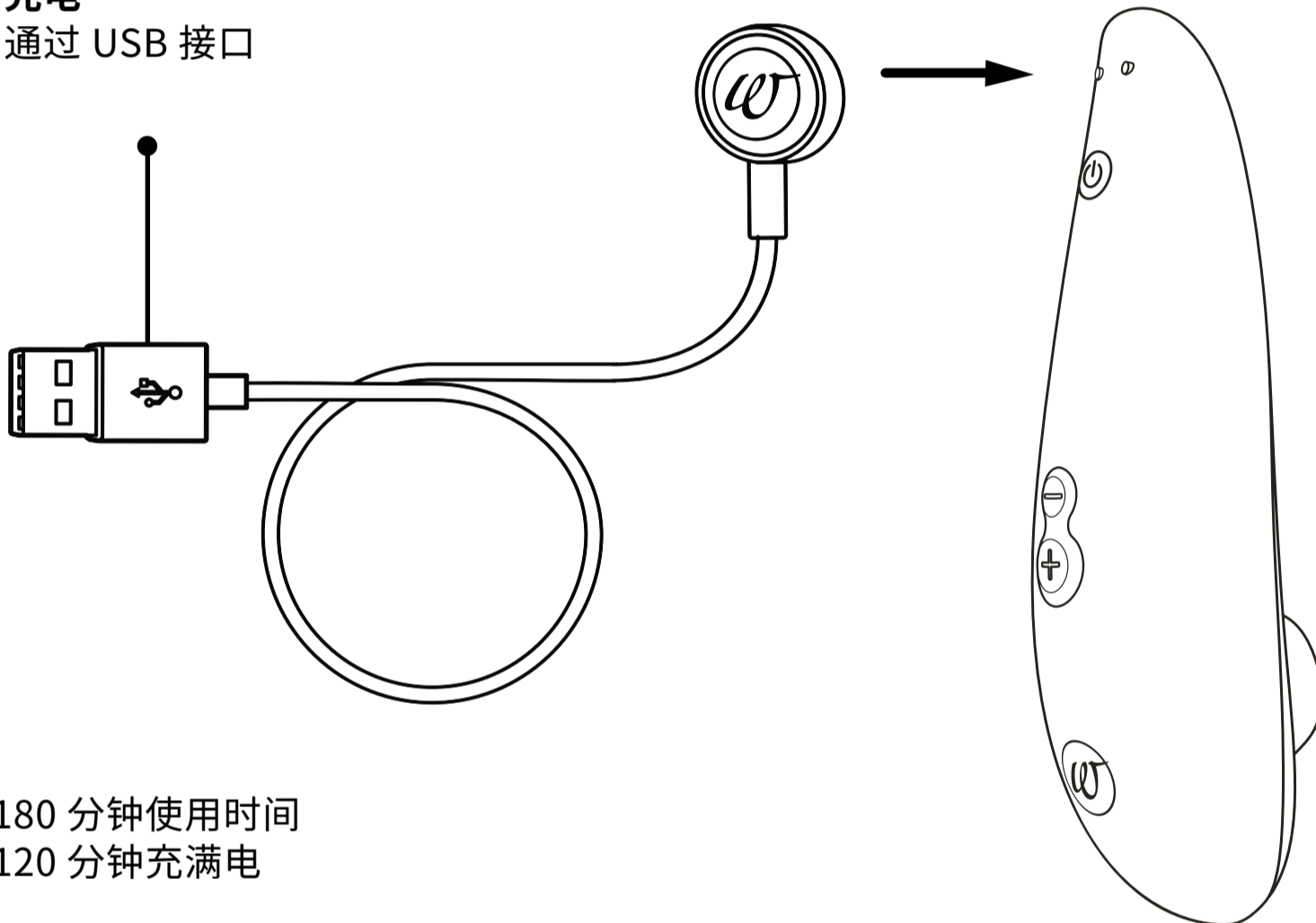

180 分钟使用时间
120 分钟充满电

LED 電源按鈕
電池電量

充滿電
LED 持續燈亮

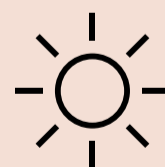

充電一半
LED 燈快速閃爍

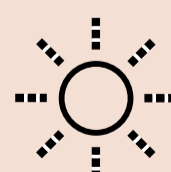

幾乎未充電
LED 燈緩慢閃爍

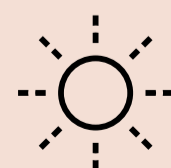

清洁

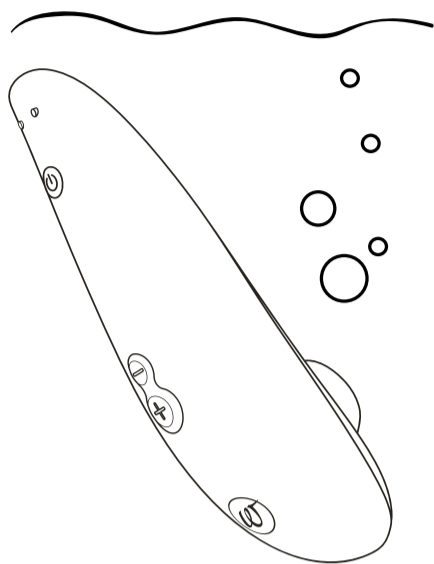

在水中清洗

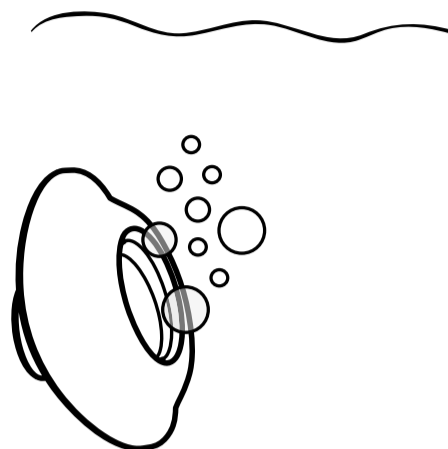

在水中清洗 водой

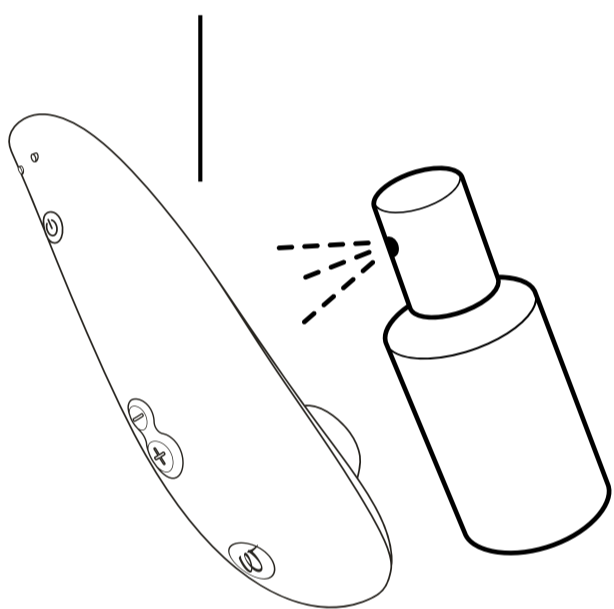

喷涂情趣玩具清洁剂

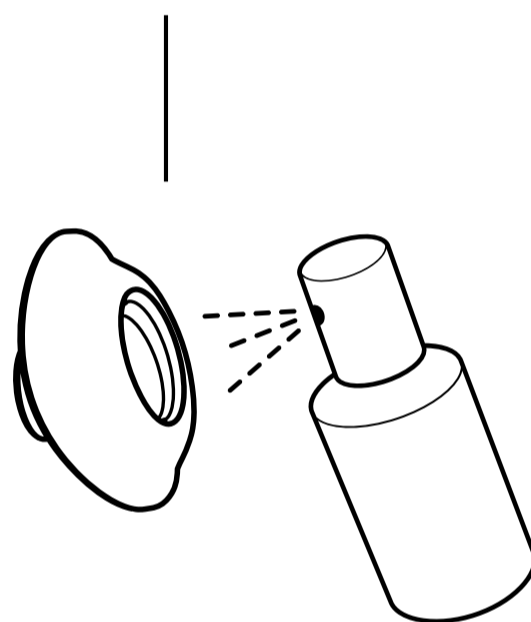

喷涂情趣玩具清洁剂

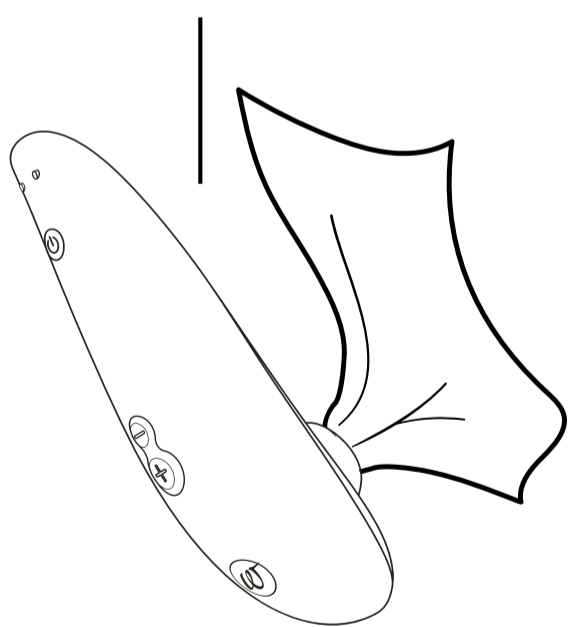

干燥

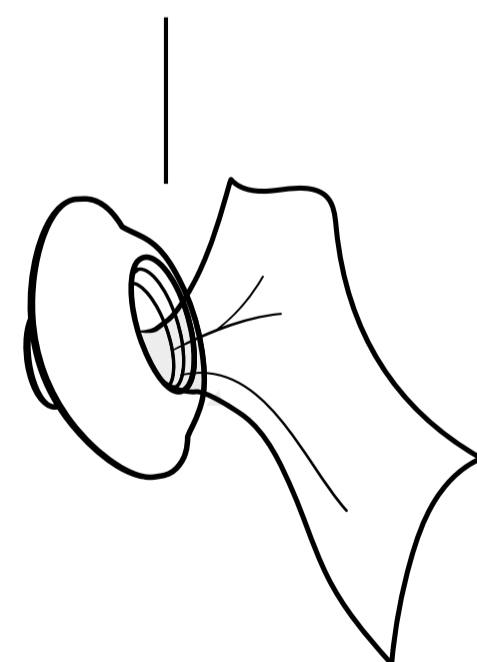

干燥



Waterproof
IPX7

一般信息

警告

请仔细阅读安全说明书,了解更多信息。
首次使用前和每次使用后,请彻底清洁 Womanizer,以降低感染风险。

客户服务

若需要更多信息,请访问我们的网站 www.womanizer.com 或联系 care@womanizer.com。

技术规格型号

型号:WZ08B
额定功率:100-240 V ~ 50/60 Hz
输出:5 V \equiv 0.75 A
产品含锂离子充电电池。
不含交流/直流转换器。

包装内容

Womanizer Classic 2、USB 充电线、棉布收纳袋、2 个吸头、快速入门指南、安全说明书。

储存

储存在安全、干燥的地方,避免阳光直射。

保修和制造商自愿保修

除了制造商为消费者提供的法定保修外,WOW TECH EUROPE GMBH 还为客户提供针对本产品的制造商自愿保修。
关于制造商自愿保修的条件,请参见我们网站上的“保修条件”。

合规性

本设备符合所有电磁兼容性 (EMC) 相关标准。只要按照本用户手册中的说明正确使用本设备,就能确保使用安全。

环境保护

作为电子设备的经销商,我们在法律上有义务免费协助回收废弃电器与电子设备。我们明确声明,用户有法律义务回收废旧电池。切勿将电子设备或电池作为生活垃圾丢弃。
下图所示的符号(我们的电子产品上也有标示)正是为了明确提醒注意环保义务。

制造商

WOW Tech Europe GmbH,
Friedenstrasse 91 / 91 a, 10249
Berlin, Germany (德国)

WOW Tech Europe GmbH 保留为改进设备而变更技术或设计的权利。

北美经销商:WOW TECH Canada Ltd.
1545 Carling Avenue, Suite 401, Ottawa
ON, Canada K1Z 8P9 (加拿大)

www.wowtech.com 德国设计。中国制造 (2021 年)。手册于 02/2021 发行。第 1 版。

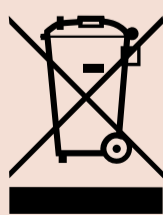

还想要更多？

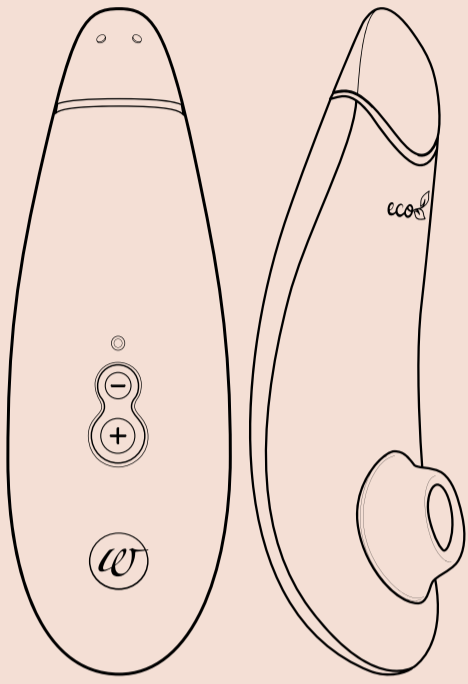

**Pleasure Air
Technology**



Smart Silence



Eco-friendly

Premium eco 

Loving Our Planet Can Be Orgasmic

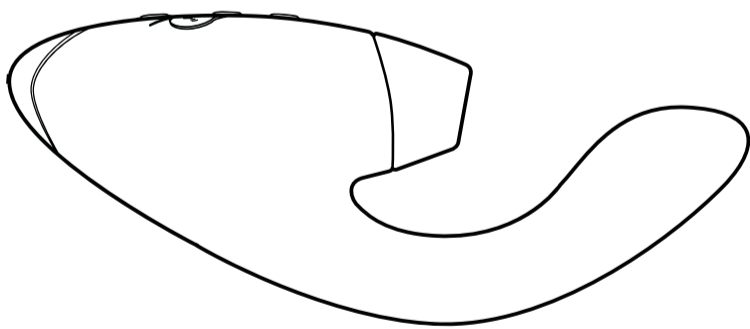

**Pleasure Air
Technology**



Vibrator



Smart Silence

DUO
Double your Pleasure

www.womanizer.com



#IMASTURBATE

어서 오세요!

Womanizer를 선택해 주셔서 감사합니다!

삶에 풍요를 더해 줄 관능적 경험의 세계에 오신 것을 환영합니다. WOMANIZER를 선택하면, 최고의 오르가즘 뿐만 아니라 완전히 새로운 즐거움도 보장받을 수 있습니다.

WOMANIZER를 즐기세요. 오르가즘이 연속해서 파도처럼 밀려 옵니다.

망설이지 말고, 자신을 사랑하세요!



제품 설명

사용 방법

충전

청소

일반 정보

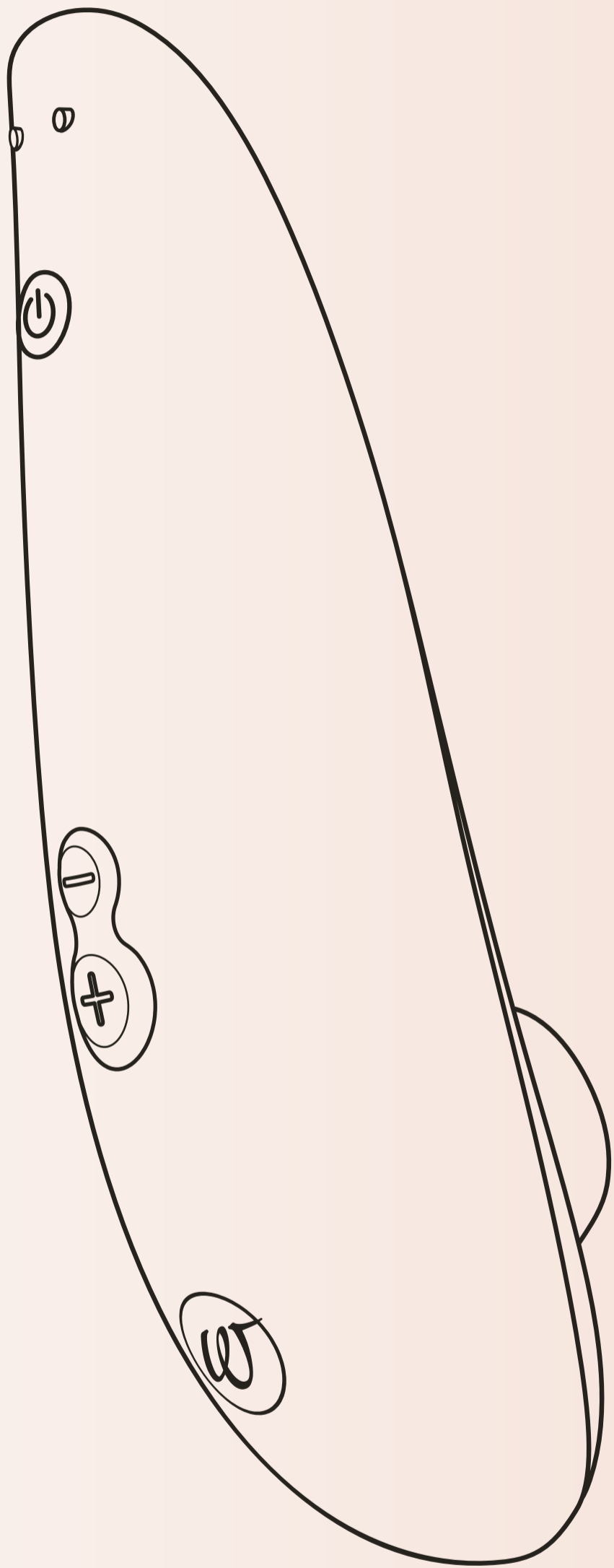

제품 설명

자기 충전 핀

켜기/끄기
2 초 동안 누릅니다

Afterglow 기능
짧게 누릅니다

강도 감소
짧게 누릅니다

강도 증가
짧게 누릅니다

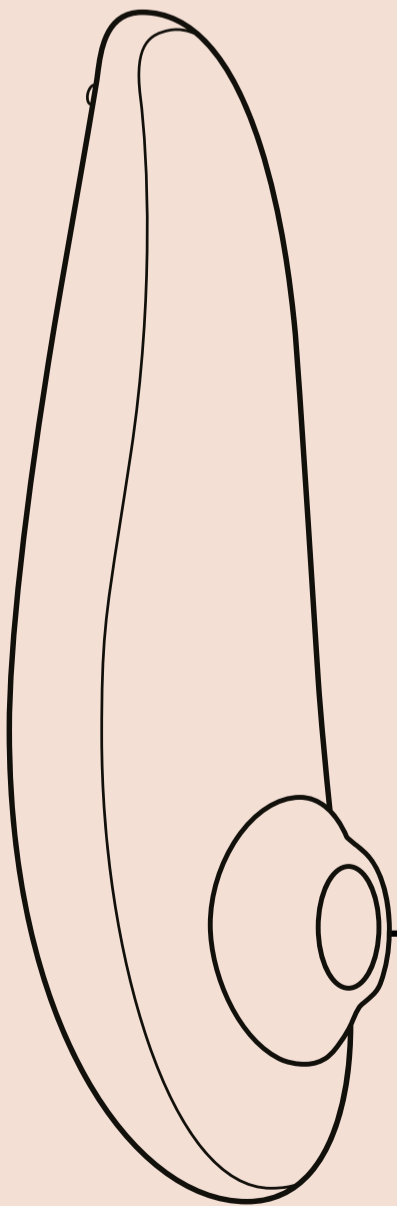
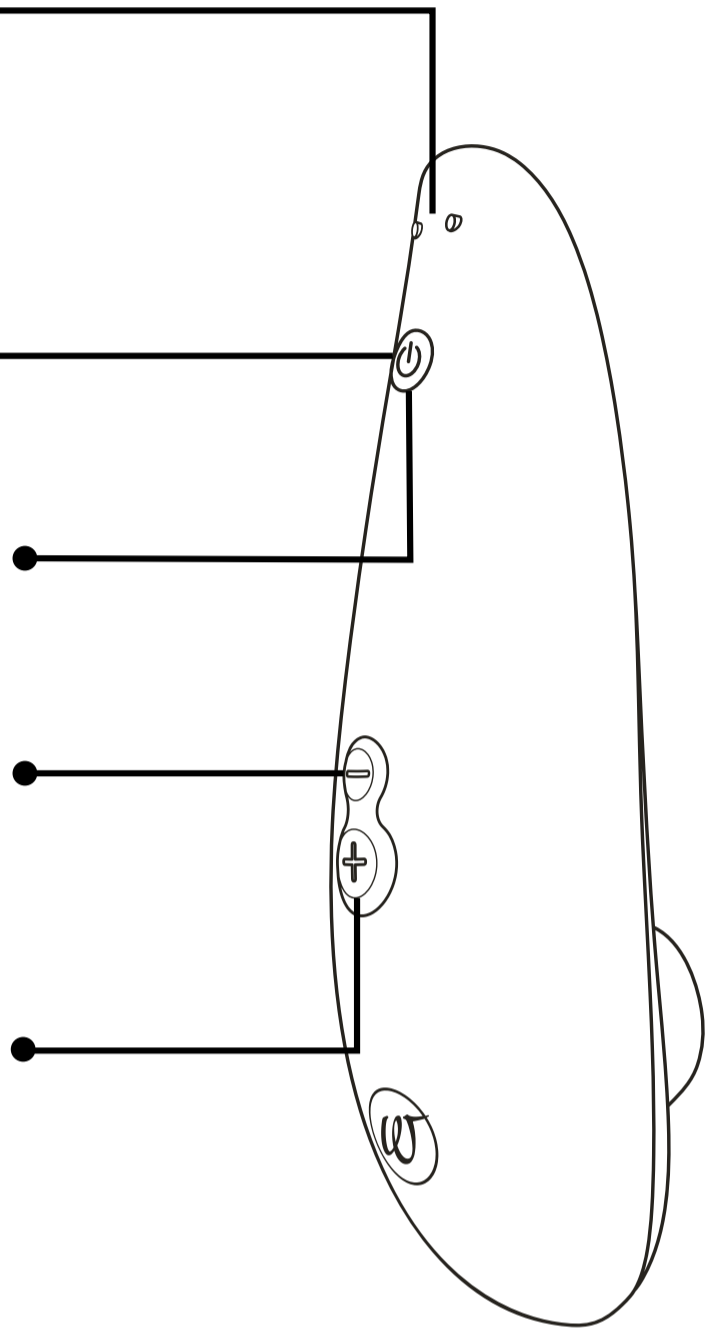

자극 헤드

사용 방법

1. 켜기

누릅니다
2 초 동안

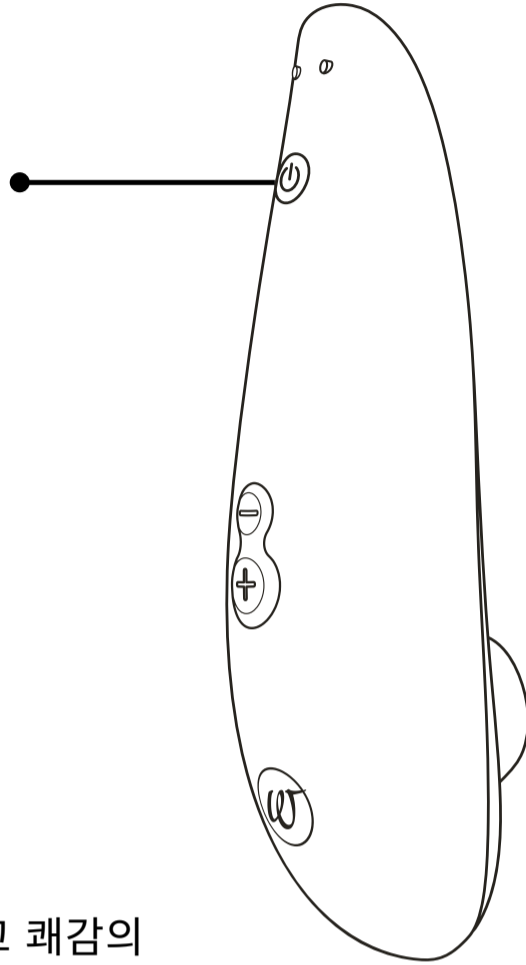

2. 사용

자극 헤드로 클리토리스를 감싸고 쾌감의 여정을 시작합니다.

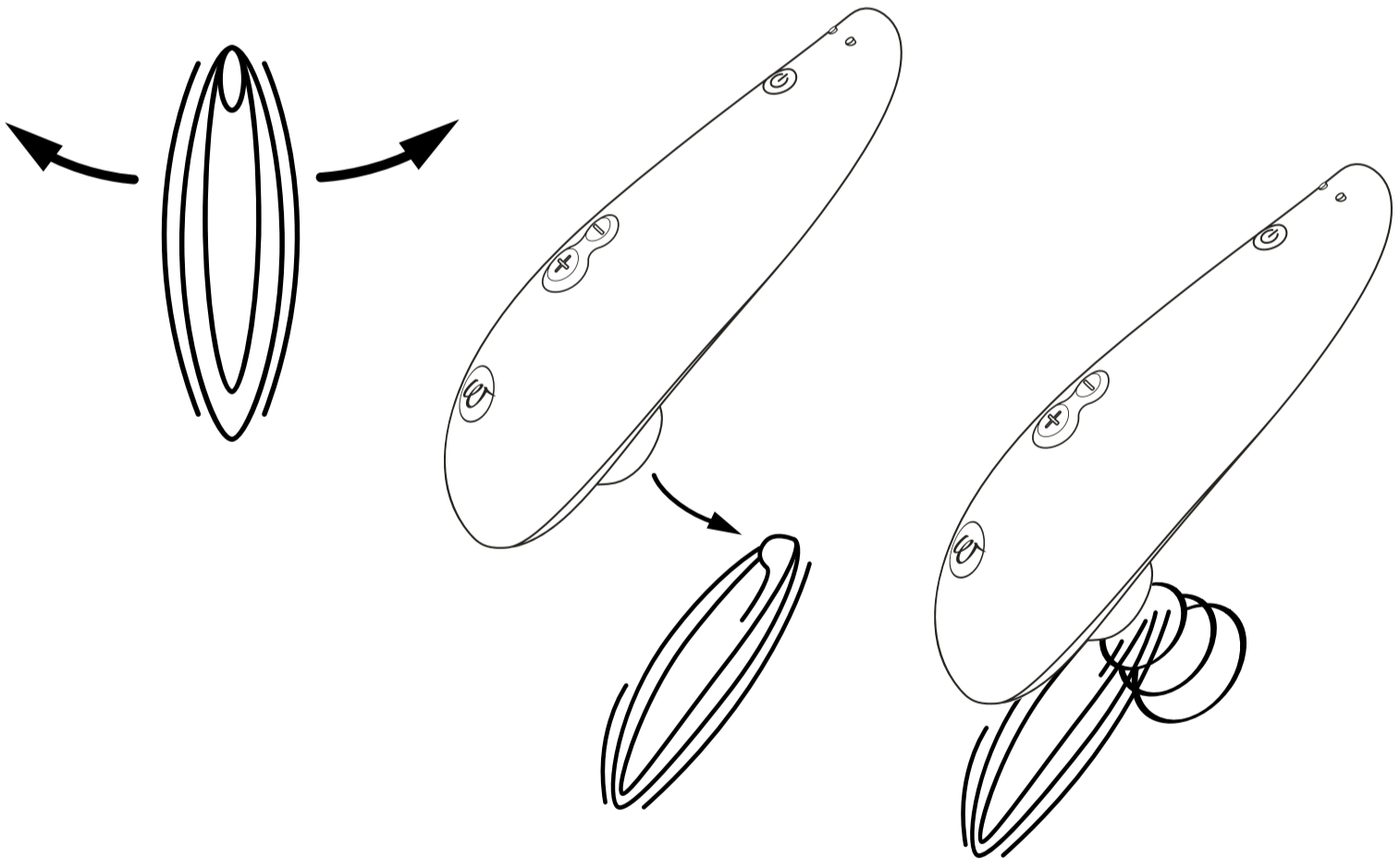

작은 팁:

자극 보조 장치가 아직 최적 적합도에 도달하지 못했다는 것을 확인하면, 장치에 포함된 자극 보조 장치 두 개(S나 M)를 교대로 작동하여 최상의 감촉을 이끌어내세요.

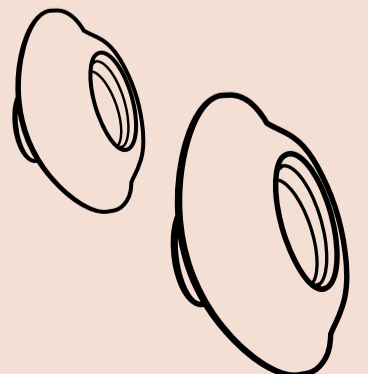

3. 강도 변경

증가
짧게 누릅니다

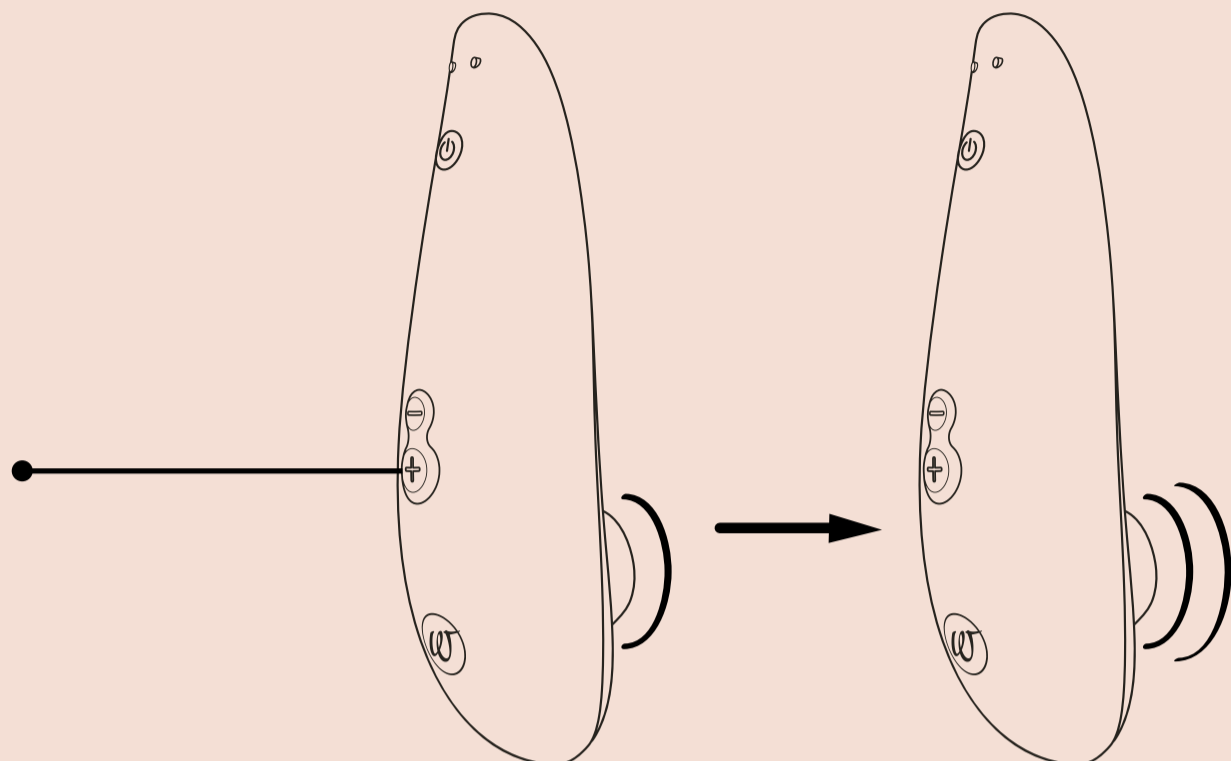

10  강도 레벨

감소
짧게 누릅니다

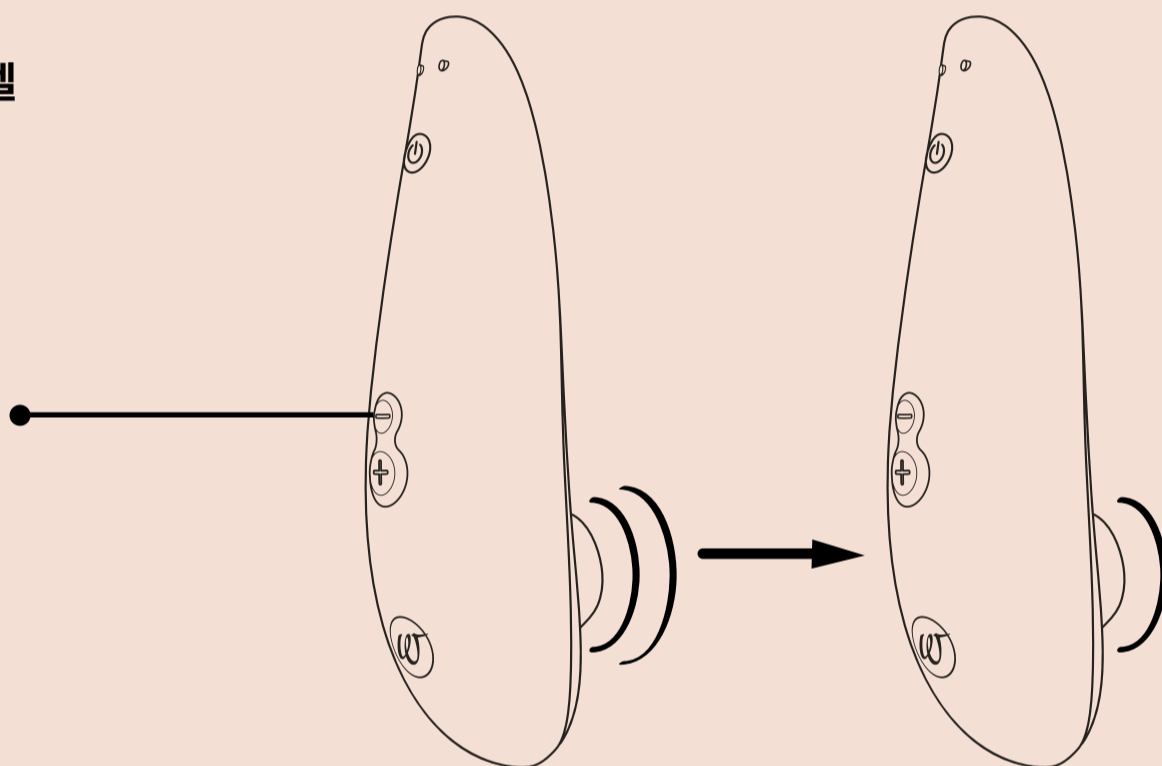

Afterglow 기능: 다시 강도 레벨 1로 떨어지도록 파워 버튼을 짧게 누릅니다.

4. 끄기

누릅니다
2 초 동안

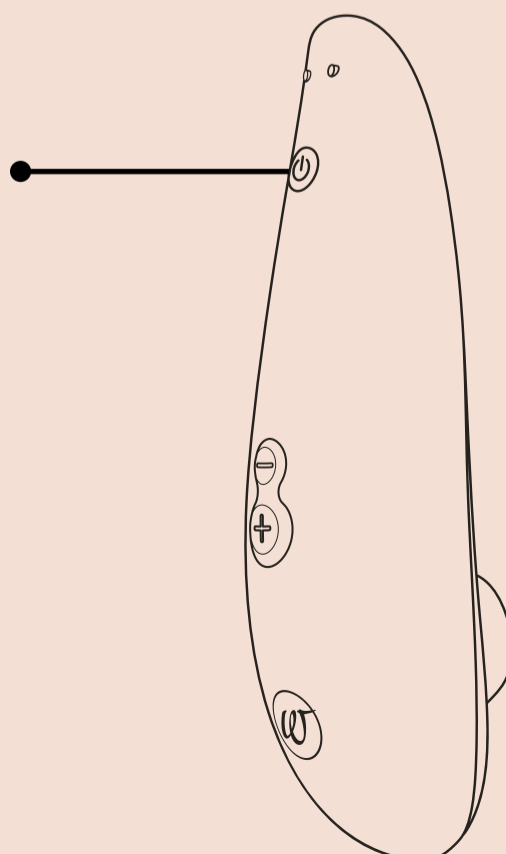

충전

처음 사용하기 전에 Womanizer를 충전해 주세요. 또한 긴 배터리 수명을 확보하려면 정기적으로 Womanizer를 재충전해야 한다는 것을 명심하세요.

충전
USB 포트를 통해

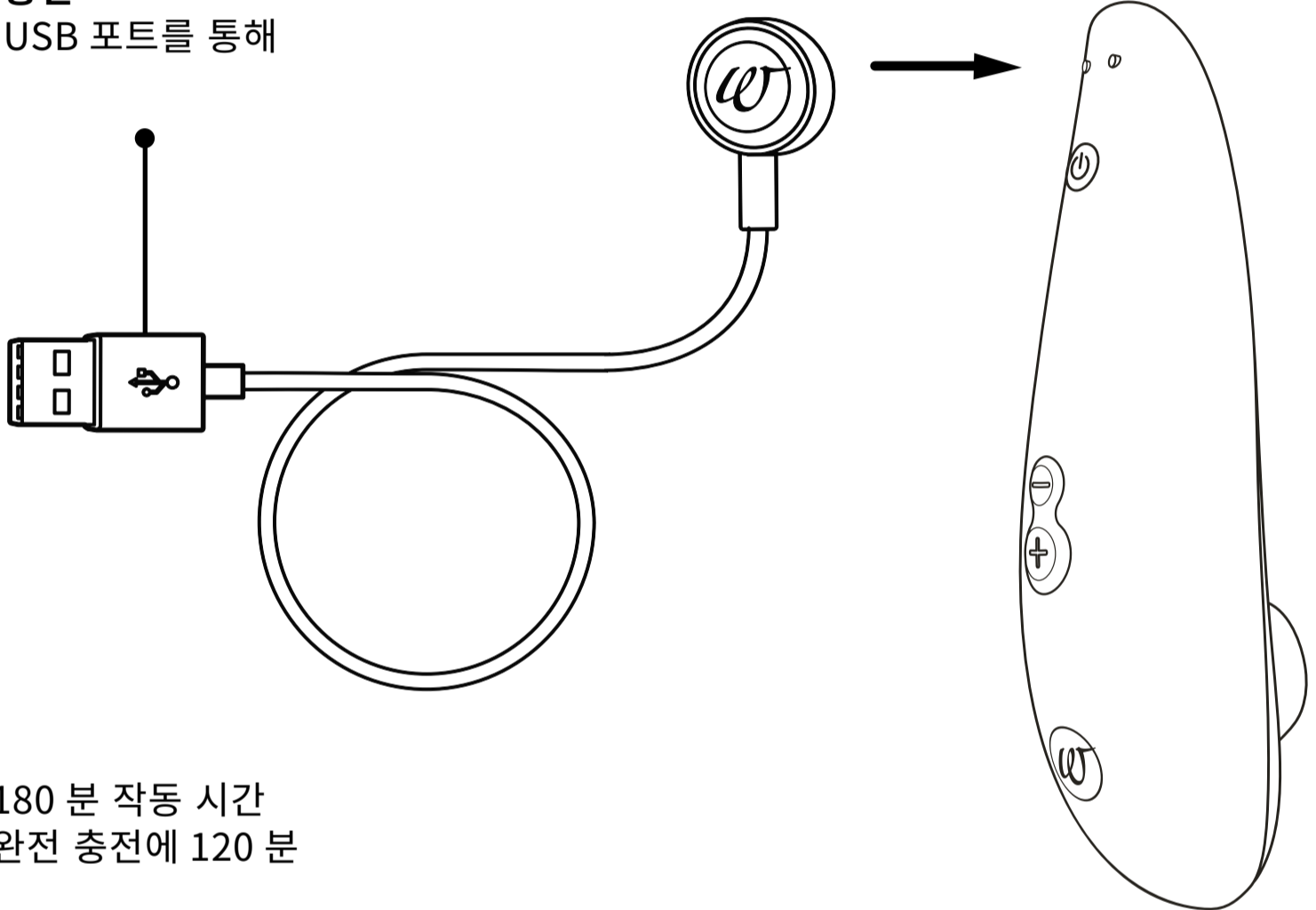

180 분 작동 시간
완전 충전에 120 분

LED 파워 버튼
배터리 레벨

완전 충전
led가 연속해서 켜집니다

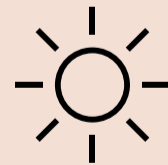

절반 충전
led가 빠르게 번쩍입니다

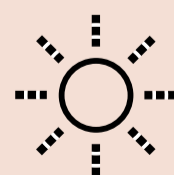

거의 방전
led가 천천히 번쩍입니다

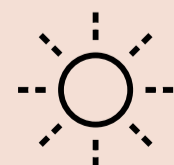

청소

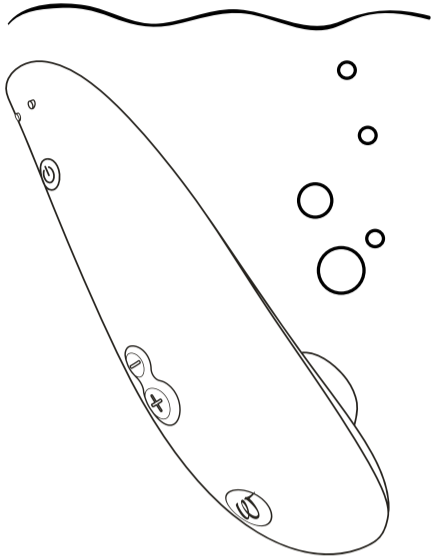

흐르는 물에 씻습니다

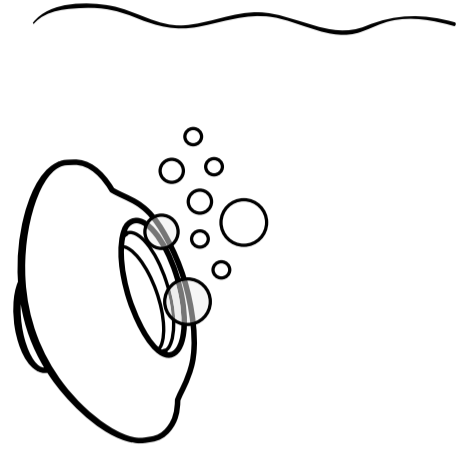

흐르는 물에 씻습니다

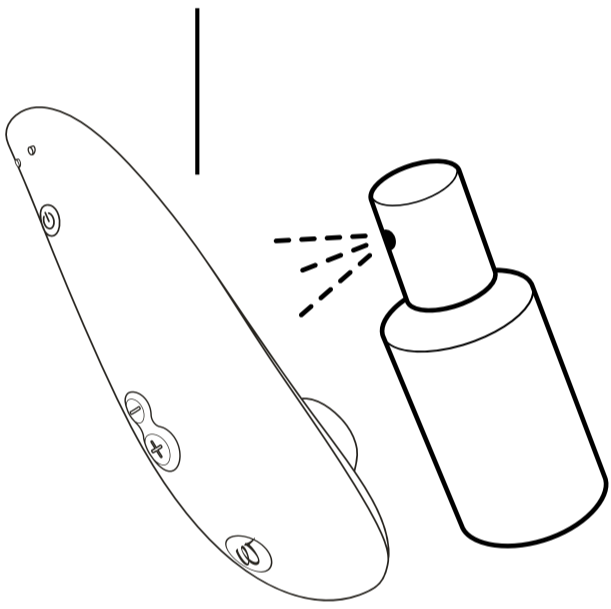

토이 클리너 사용

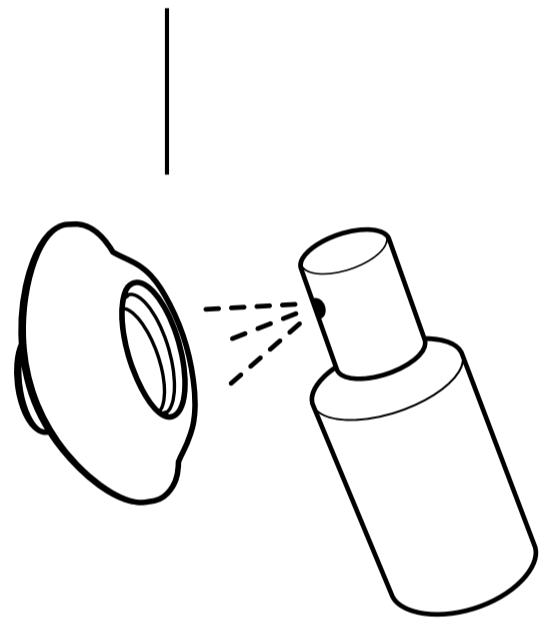

토이 클리너 사용

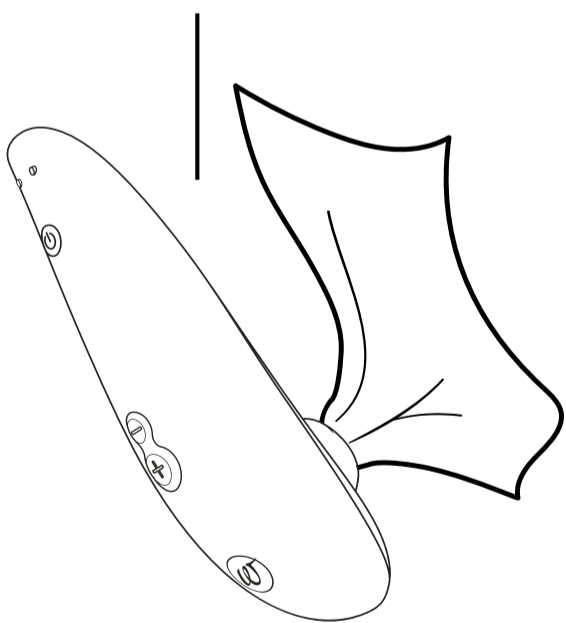

건조

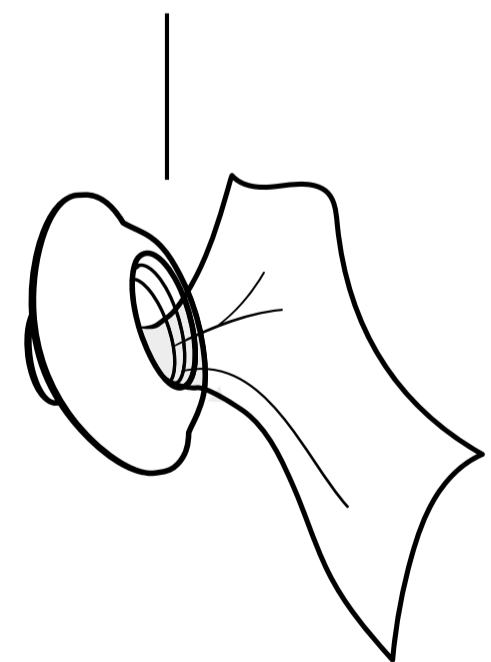

건조



Waterproof
IPX7

일반 정보

경고

추가 정보를 원하면 안전 지침을 주의 깊게 읽어 주세요.
감염 위험을 줄이려면 처음 사용하기 전과 사용 후에는 매번 Womanizer를 철저히 청소하세요.

고객 관리

추가 정보는 당사 웹사이트 www.womanizer.com을 방문하거나 care@womanizer.com에 연락하여 확인하시기 바랍니다.

기술 사양

모델: WZ08B
전력 등급: 100-240 V ~ 50/60 Hz
출력: 5 V = 0.75 A
리튬 이온 충전지 포함.
AC/DC 어댑터 포함되지 않음.

납품 내용물

Womanizer Classic 2, USB 충전 케이블, 무명 보관 파우치, 2 개 자극 헤드, 퀵 스타트 가이드, 안전 지침.

보관

직사 광선에 노출하지 말고 안전하고 건조한 장소에 보관하세요.

보증 및 자발적 제조사 보증

WOW TECH EUROPE GMBH에서는 소비자가 판매자에 대해 갖는 법적 보증권 외에 본 제품에 대한 자발적 제조사 보증을 고객에게 제공합니다.
자발적 제조사 보증에 관한 조건은 당사 웹사이트의 „보증 조건“ 항목에 있습니다.

기준 이행

본 기기는 전자기 호환성(EMC)에 관한 모든 기준과 부합합니다. 본 장치는 정확하게 그리고 본 사용 설명서의 지침에 따라 사용하는 한 안전하게 사용할 수 있습니다.

환경 보호

전자 장비 유통 회사로서, 당사는 무료로 폐기 전기 및 전자 장비 반환을 받아야 할 법적 의무가 있습니다. 당사는 사용자는 사용한 배터리를 법적으로 반환할 법적 의무가 있다고 명확하게 선언합니다. 절대로 전자 장비나 배터리를 가정 쓰레기에 담아 버리지 마세요.
하기 기호는 당사 전자 제품들에도 부착되는데 위의 사실을 명확하게 환기하고자 하는 것입니다.

제조사

WOW Tech Europe GmbH,
Friedenstrasse 91 / 91 a, 10249 Berlin,
Germany

WOW Tech Europe GmbH에서는 장치 개선에 도움이 되는 기술 및 설계 개선의 권리를 보유하고 있습니다.

북미 지역 유통 회사: 1545 Carling Avenue,
Suite 401, Ottawa ON, Canada K1Z 8P9

www.wowtech.com Designed in Germany. 2021년 중국에서 제조. 2021년 2월 매뉴얼 발행. 버전 1.

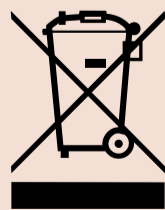

아직 더 원하세요?

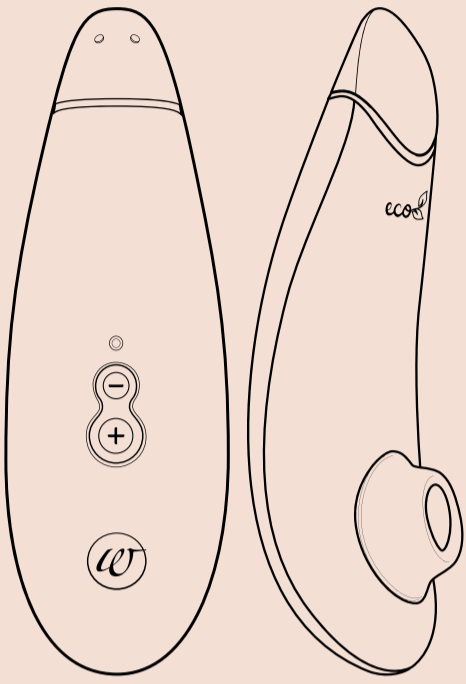

**Pleasure Air
Technology**



Smart Silence



Eco-friendly

Premium eco 

Loving Our Planet Can Be Orgasmic

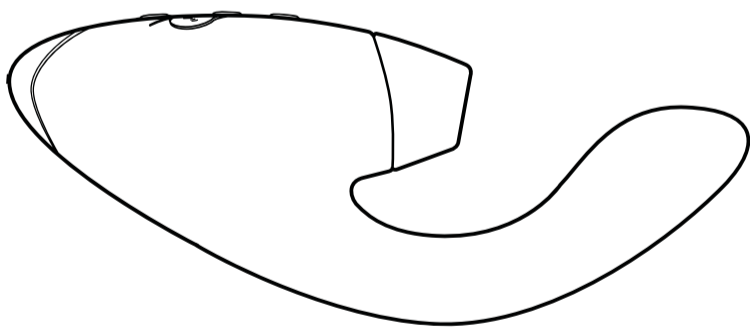

**Pleasure Air
Technology**



Vibrator



Smart Silence

DUO
Double your Pleasure



#IMASTURBATE

嗨！

Womanizer를 선택해 주셔서 감사합니다!

歡迎探索快感迭起的情趣世界，生活從此更加豐富多彩。選擇 WOMANIZER，您不僅可以享受無與倫比的美好高潮，還能擁有全新的歡愉慾望。

享受 WOMANIZER - 帶給您一次又一次的高潮

好好愛自己！



產品說明

如何使用

充電

清潔

一般資訊

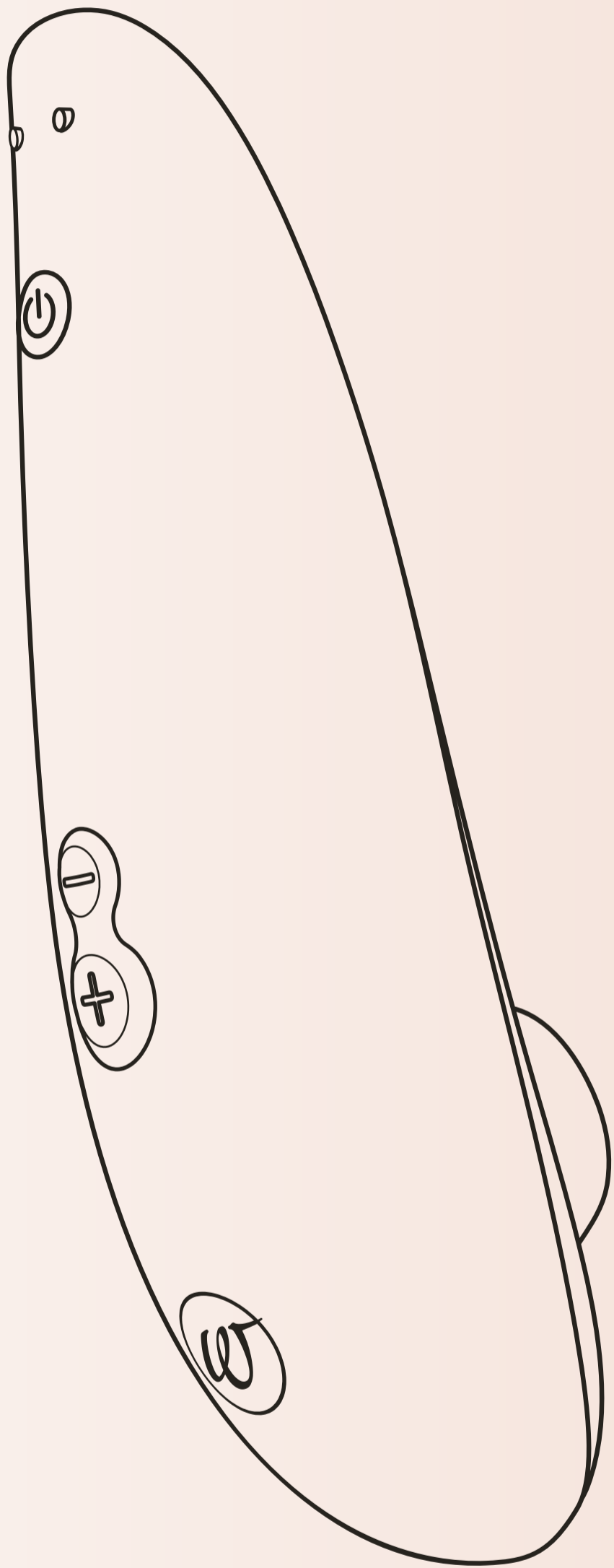

產品說明

磁吸充电头

開啟／關閉
按壓 2 秒

Afterglow 餘韻功能
短按

降低強度
短按

增加強度
短按

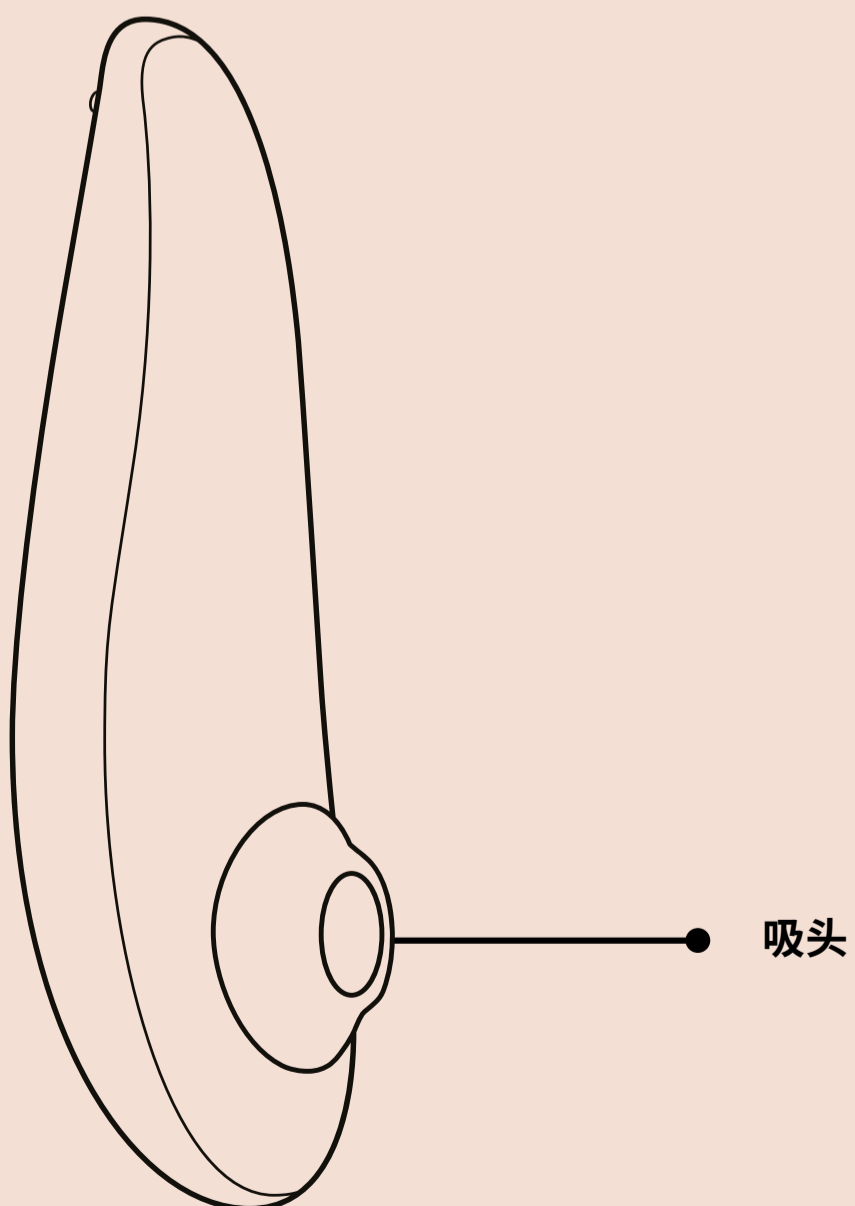
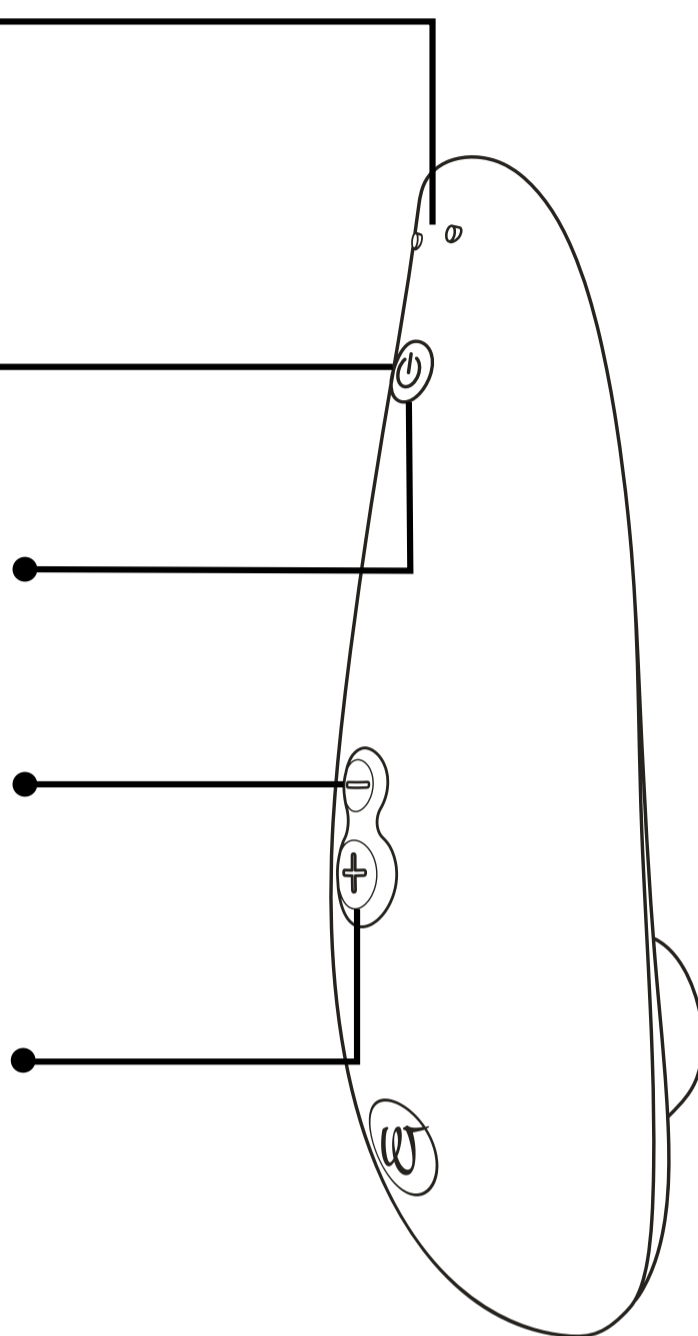

如何使用

1. 開啟電源

按壓
2 秒

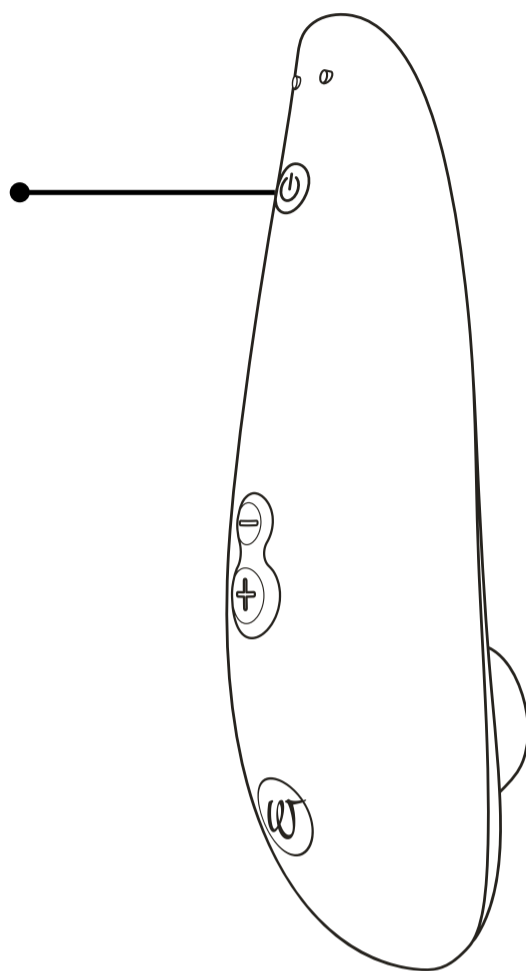

2. 使用方法

用吸吮頭裹含陰蒂，開啟唯妳獨享的美妙時光。

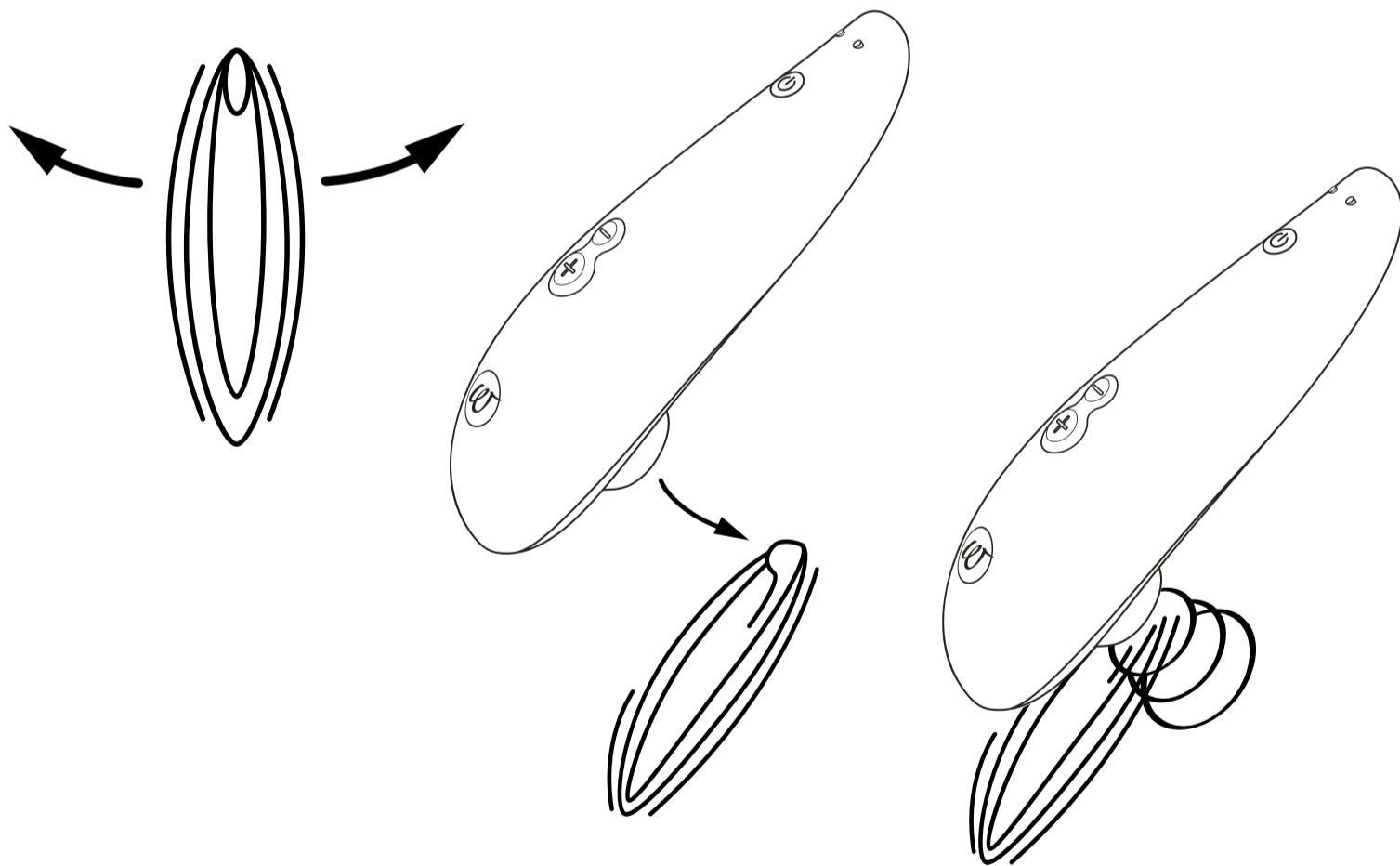

小提示：

如果您發現按摩器吸頭未最佳貼合，請選擇隨設備一起提供的兩個吸頭 (S 或 M) 進行替換，為您創造最佳體驗。

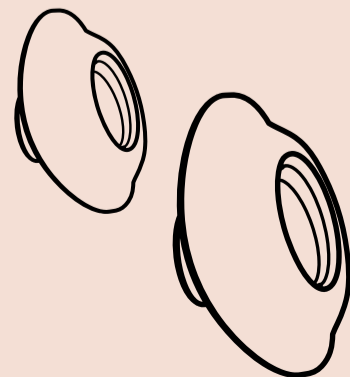

3. 改变强度

增加
短按

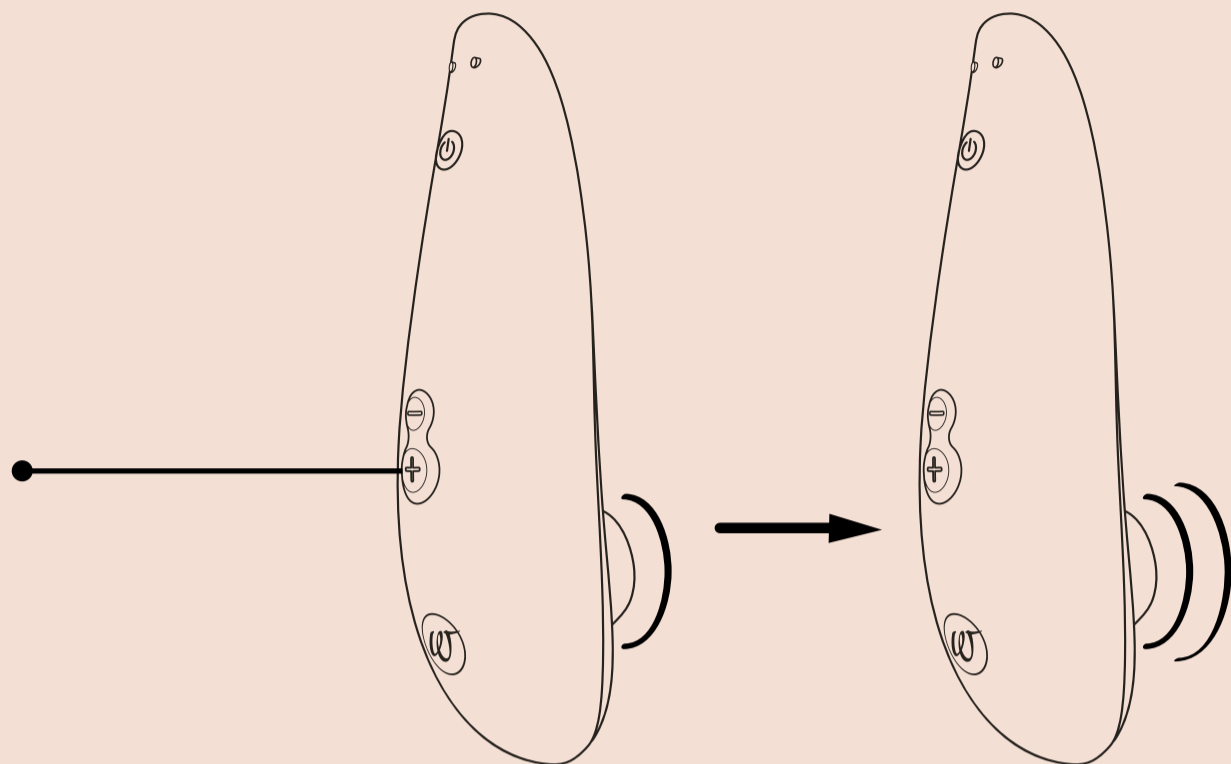

10  强度選擇

降低
短按

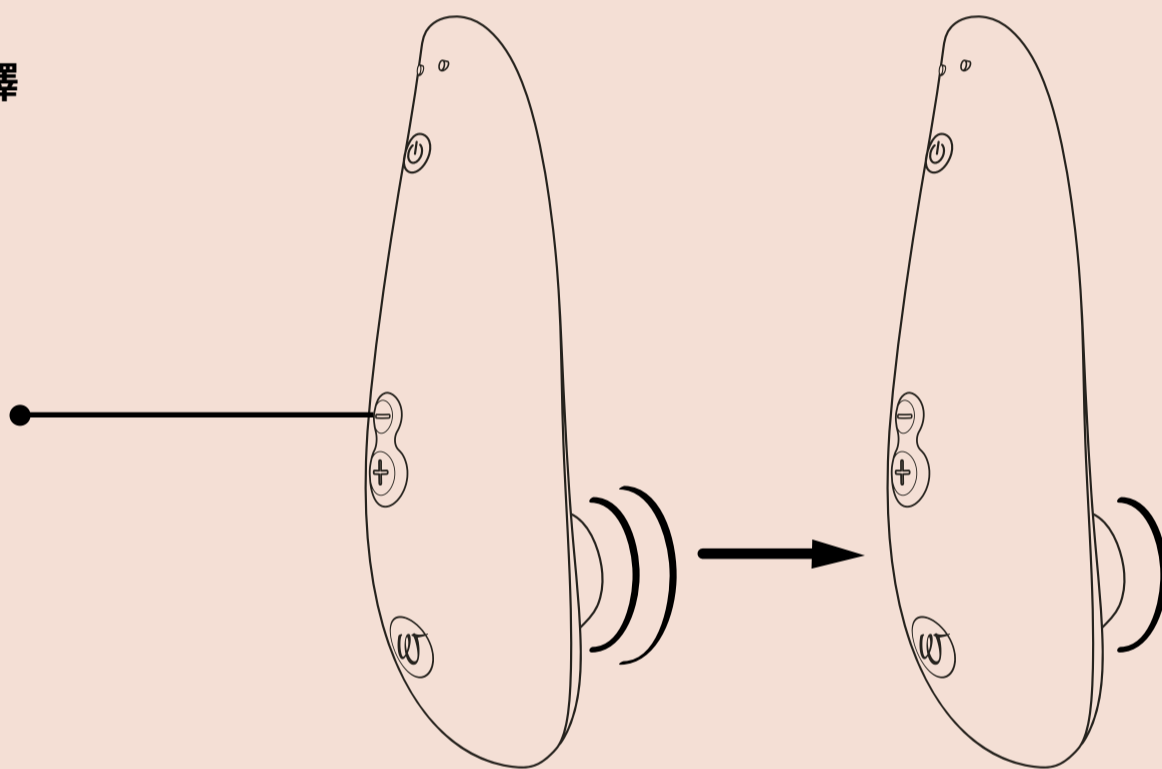

Afterglow 餘韻功能：短按電源按鈕可返回強度等級 1。

4. 關閉

按壓
2 秒

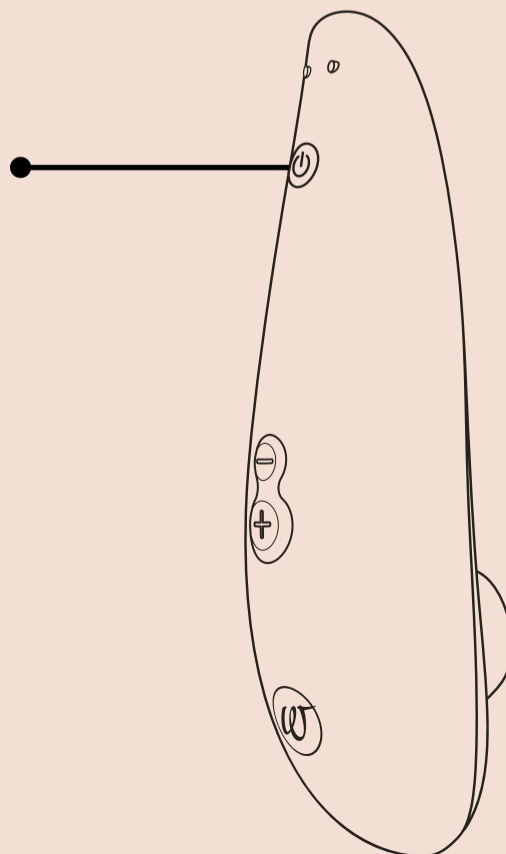

充電

請在首次使用前為您的 Womanizer 充電。同時也請記住應定期為 Womanizer 充電，確保電池能保有較長壽命。

充電
透過 USB 埠

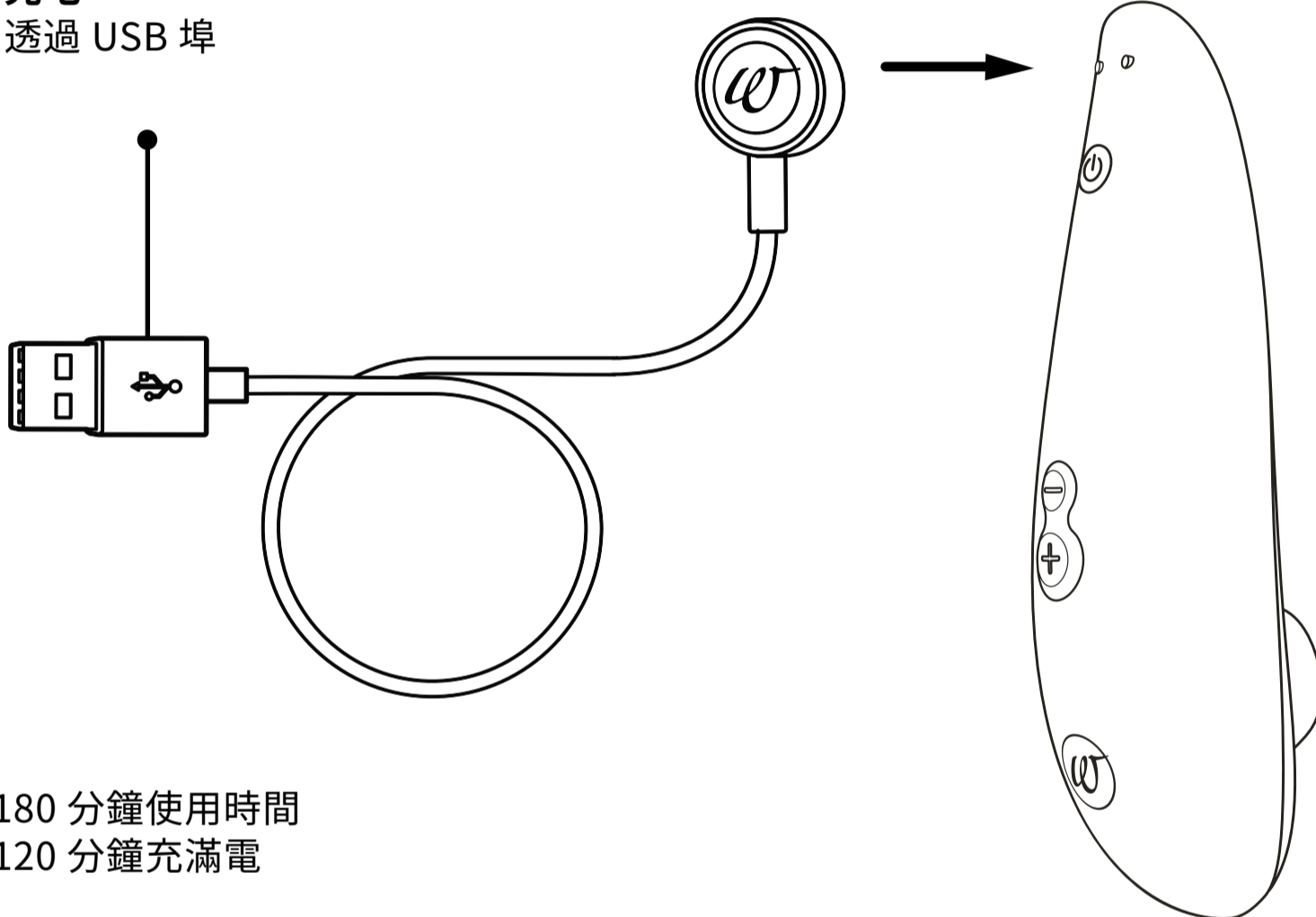

180 分鐘使用時間
120 分鐘充滿電

LED 電源按鈕
電池電量

充滿電
LED 持續燈亮

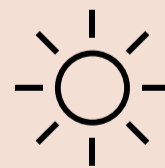

充電一半
LED 燈快速閃爍

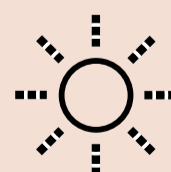

幾乎未充電
LED 燈緩慢閃爍

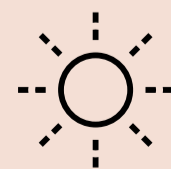

清潔

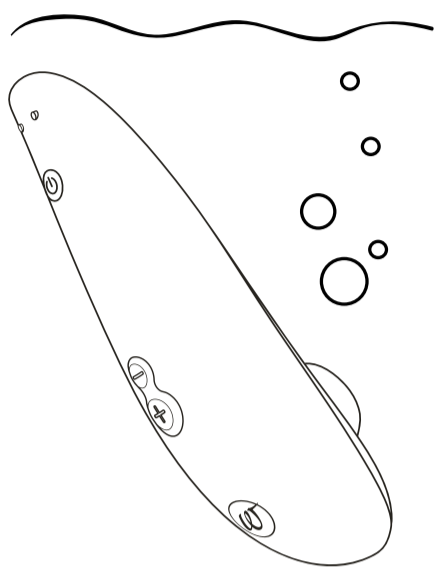

在水中清洗

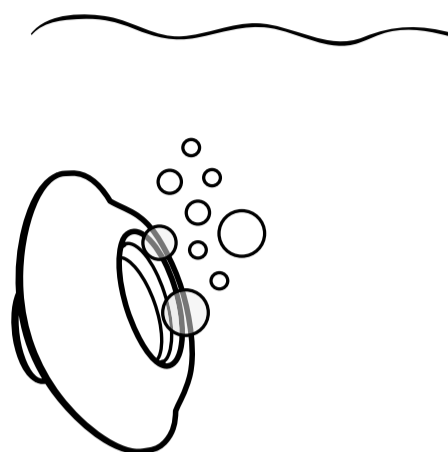

在水中清洗

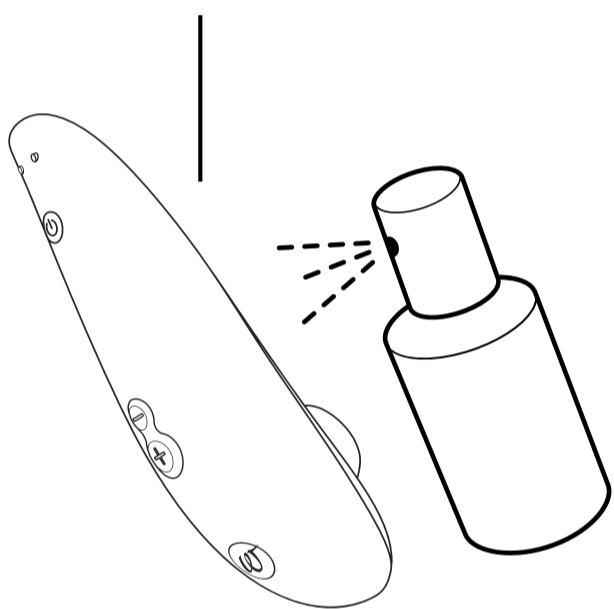

喷涂情趣玩具清洁剂

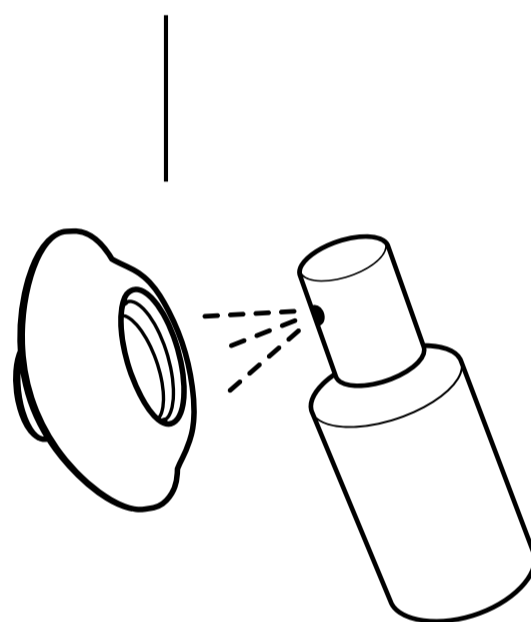

喷涂情趣玩具清洁剂

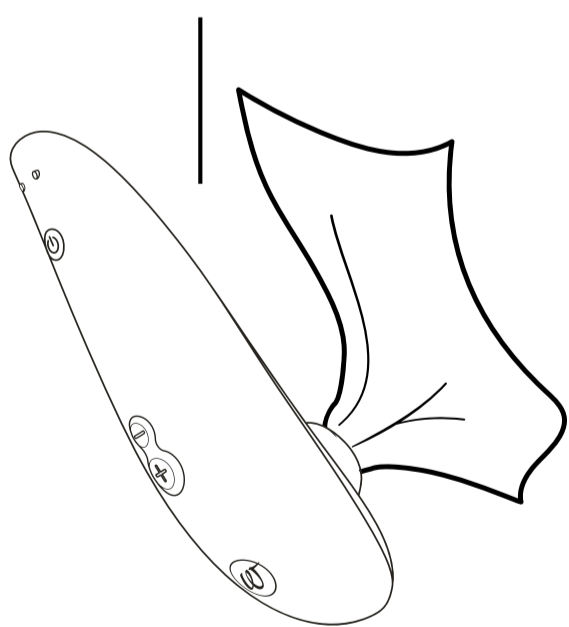

干燥

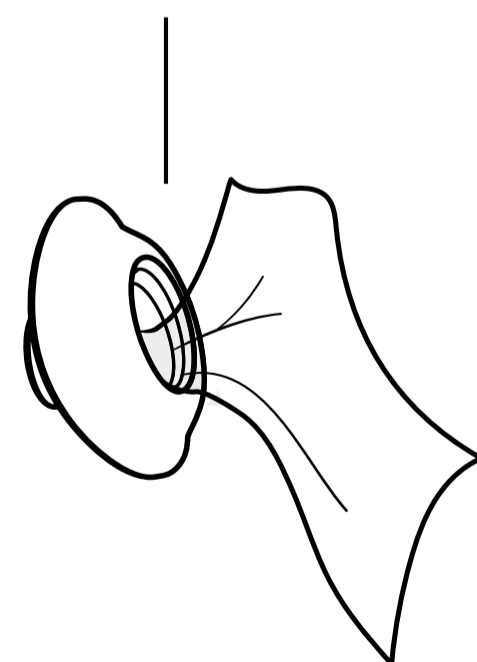

干燥



Waterproof
IPX7

還想要更多？

警告

請仔細閱讀安全說明書，了解更多資訊。
首次使用前和每次使用後，請徹底清潔
Womanizer，以降低感染風險。

客户服务

若需要更多信息，请访问我们的网站
www.womanizer.com 或联系
care@womanizer.com。

技術規格型號

型號：WZ09B
額定功率：100-240 V ~ 50/60 Hz
輸出：5V = 1A
產品含鋰離子充電電池。
不含交流／直流轉接器。

包裝內容

Womanizer Premium 2、USB 充電線、棉布
收納袋、2 個吸頭、快速入門指南、安全說明書

儲存

儲存在安全、乾燥的地方，避免陽光直射。

保固和製造商自願保固

除了製造商為消費者提供的法定保固
外，WOW TECH EUROPE GMBH 還為客戶提
供針對本產品的製造商自願保固。
關於製造商自願保固的條件，請參見我們網站
上的「保固條件」。

合规性

本設備符合所有電磁相容性 (EMC) 相關標
準。只要按照本使用者手冊中的說明正確使用
本設備，就能確保使用安全。

环境保护

作為電子設備的經銷商，我們在法律上有義務
免費協助回收廢棄電器與電子設備。我們明確
聲明，用戶有法律義務回收廢舊電池。切勿將
電子設備或電池作為生活垃圾丟棄。
下圖所示的符號（我們的電子產品上也有標
示）正是為了明確提醒注意環保義務。

製造商

WOW Tech Europe GmbH,
Friedenstrasse 91 / 91 a, 10249
Berlin, Germany (德国)

WOW Tech Europe GmbH 保留为改进设
备而变更技术或设计的权利。

北美經銷商：WOW TECH Canada Ltd.
1545 Carling Avenue, Suite 401, Ottawa
ON, Canada K1Z 8P9 (加拿大)

www.wowtech.com 德國設計。中國製造
(2021 年)。手冊於 02/2021 發行。第 1
版。

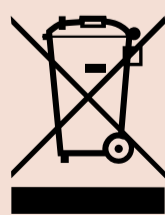

아직 더 원하세요?

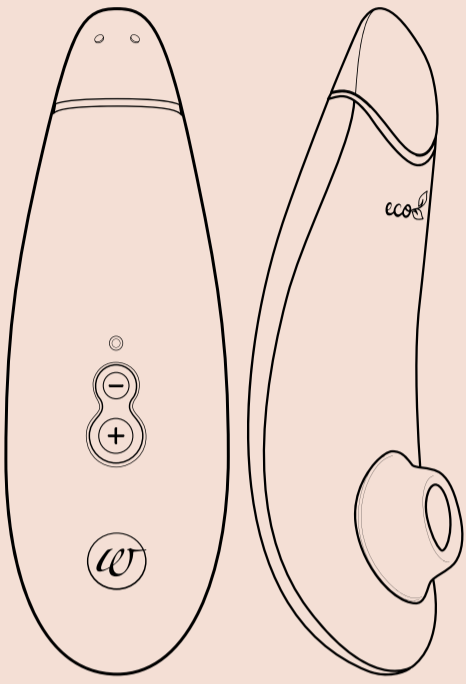

**Pleasure Air
Technology**



Smart Silence



Eco-friendly

Premium eco 

Loving Our Planet Can Be Orgasmic

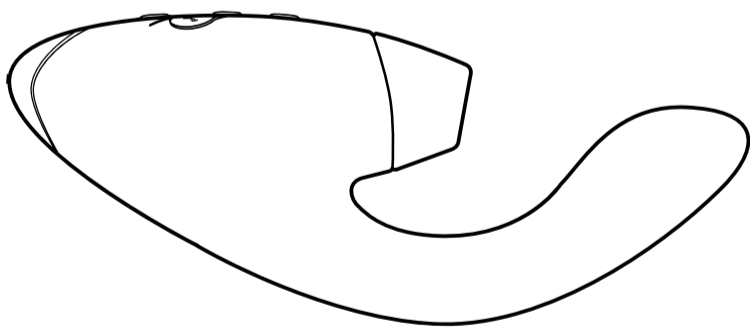

**Pleasure Air
Technology**



Vibrator



Smart Silence

DUO
Double your Pleasure



#IMASTURBATE

こんにちは!

Womanizer をご購入いただき、ありがとうございます!

セックスライフを豊かに彩る官能の世界にようこそ。WOMANIZER なら、至高のオーガズムを感じることもできるだけでなく、新たな歓びの世界を発見できるはずです。

WOMANIZER と共に、エンドレスな官能を体感しましょう。

あなたに、心からの愛を!



製品説明

使用方法

充電

お手入れ

一般情報

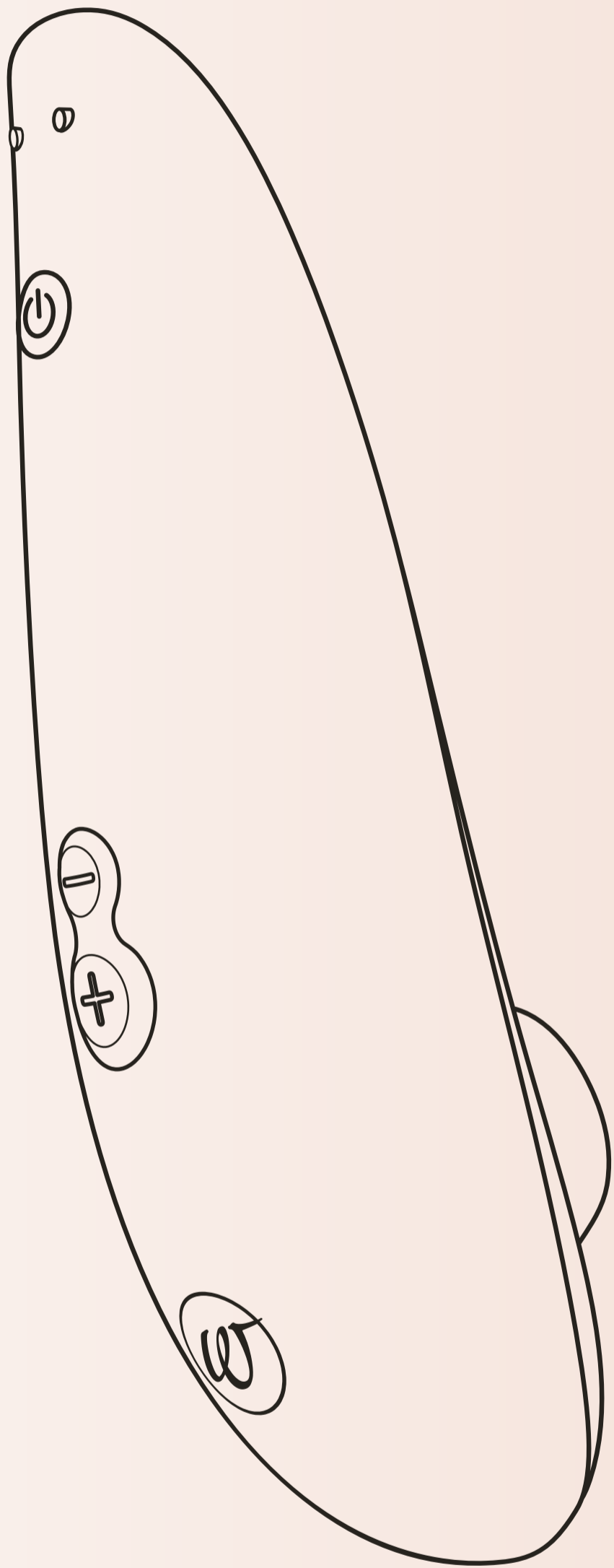

製品説明

磁気充電ピン

オン/オフ
2 秒間押します

Afterglow 機能
軽く押します

強度を弱める
軽く押します

強度を強める
軽く押します

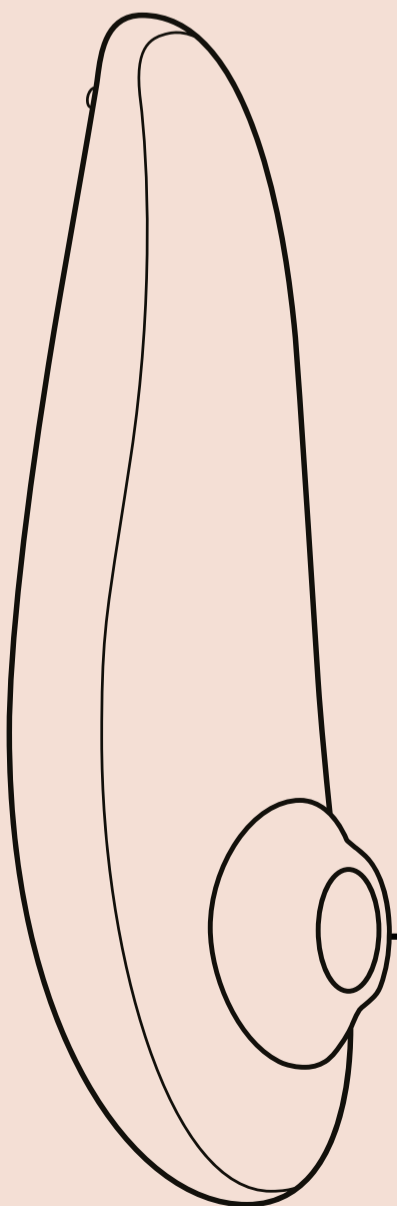
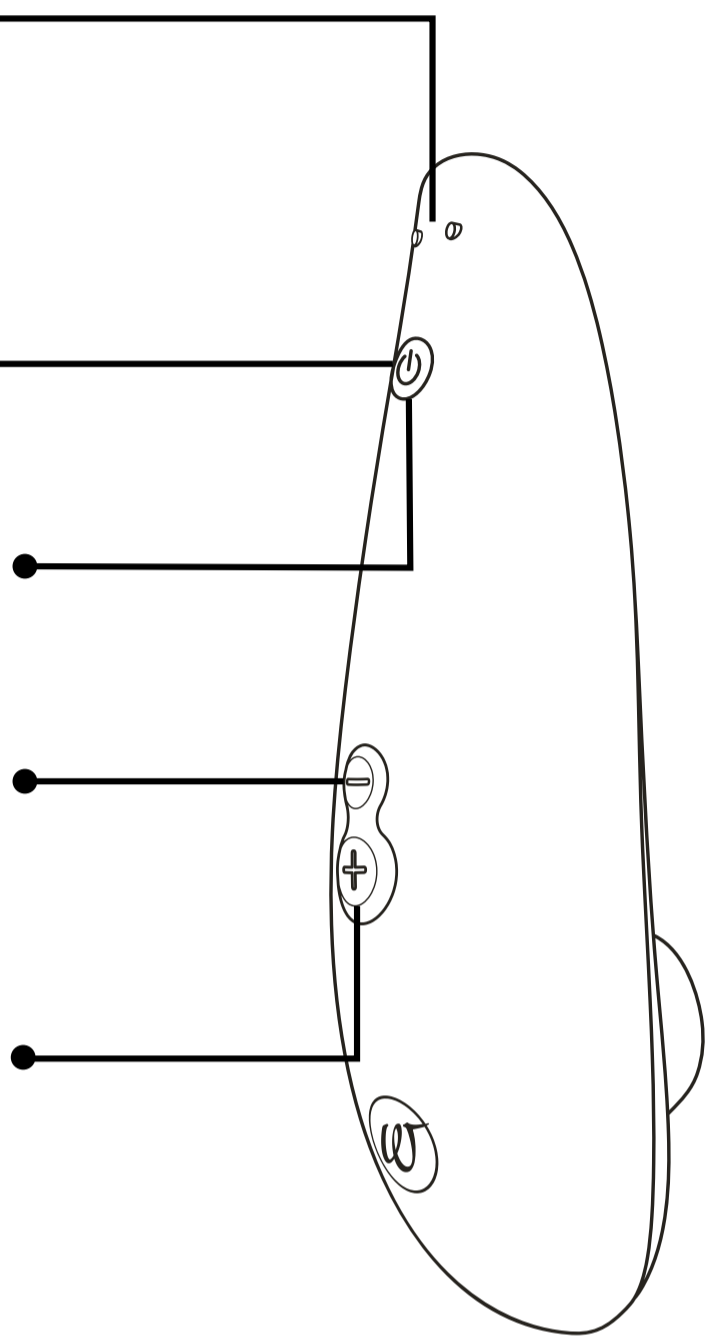

● スティミュレーションヘッド

使用方法

1. 電源を入れる

スイッチを
2 秒間押します

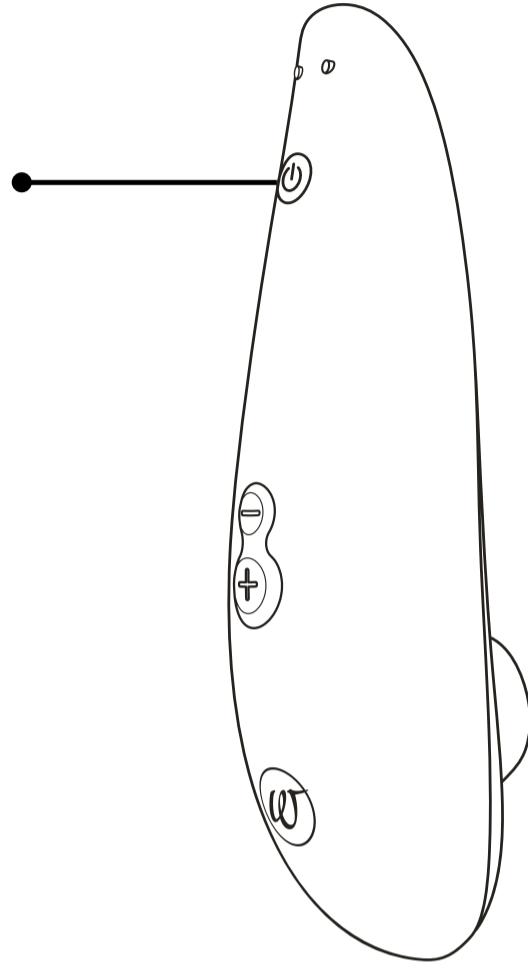

2. 使い方

スティミュレーター
ヘッドでクリトリスを包みます。

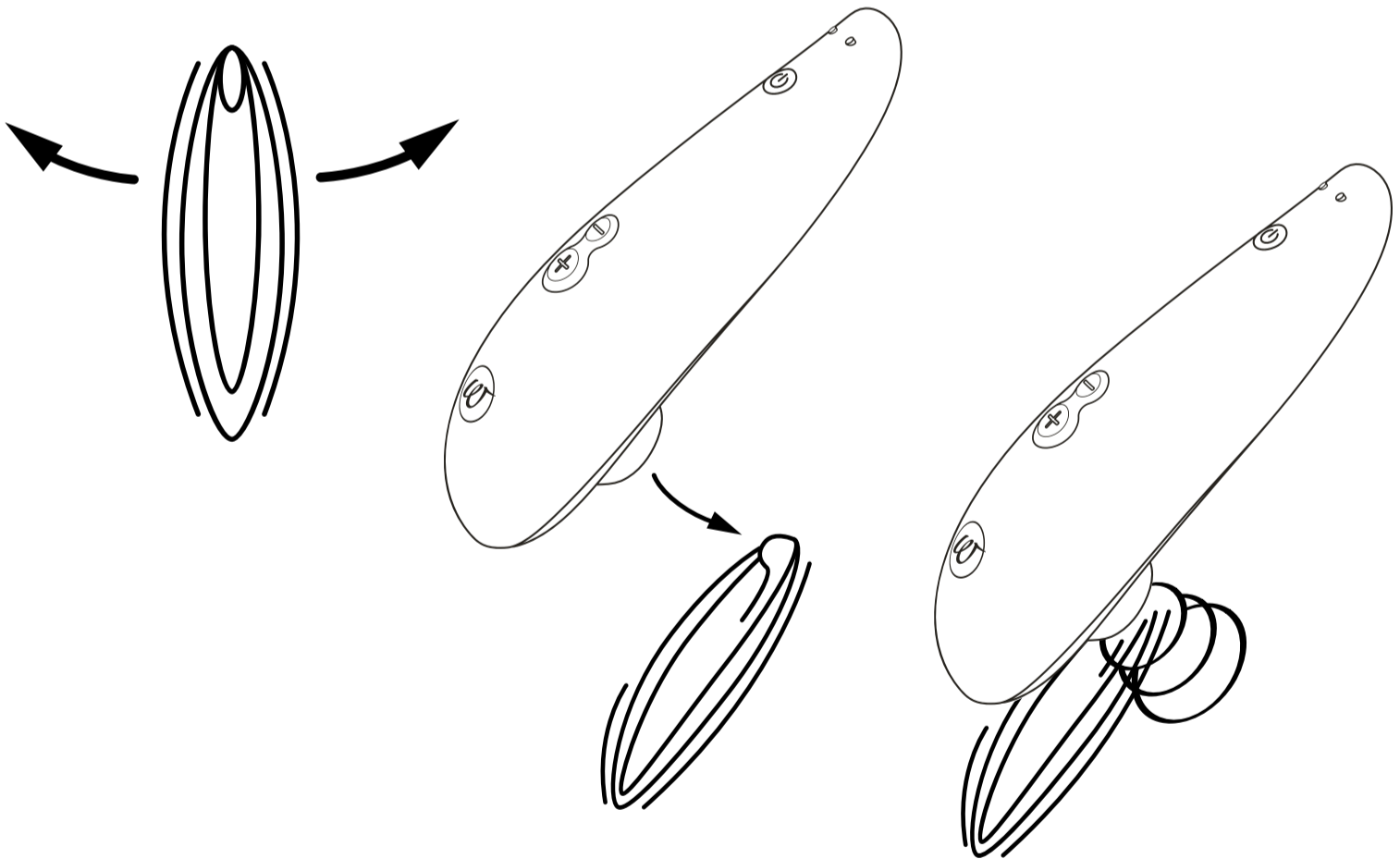

アドバイス:

スティミュレーションアタッチメントがいまいちフィットしない場合は、スティミュレーションアタッチメントのサイズを変更してみてください(SもしくはM)。満足できる、最高のフィット感を探してみてください。

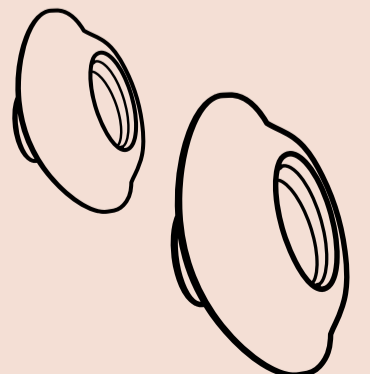

3.強度の切替え

強くする
軽く押します

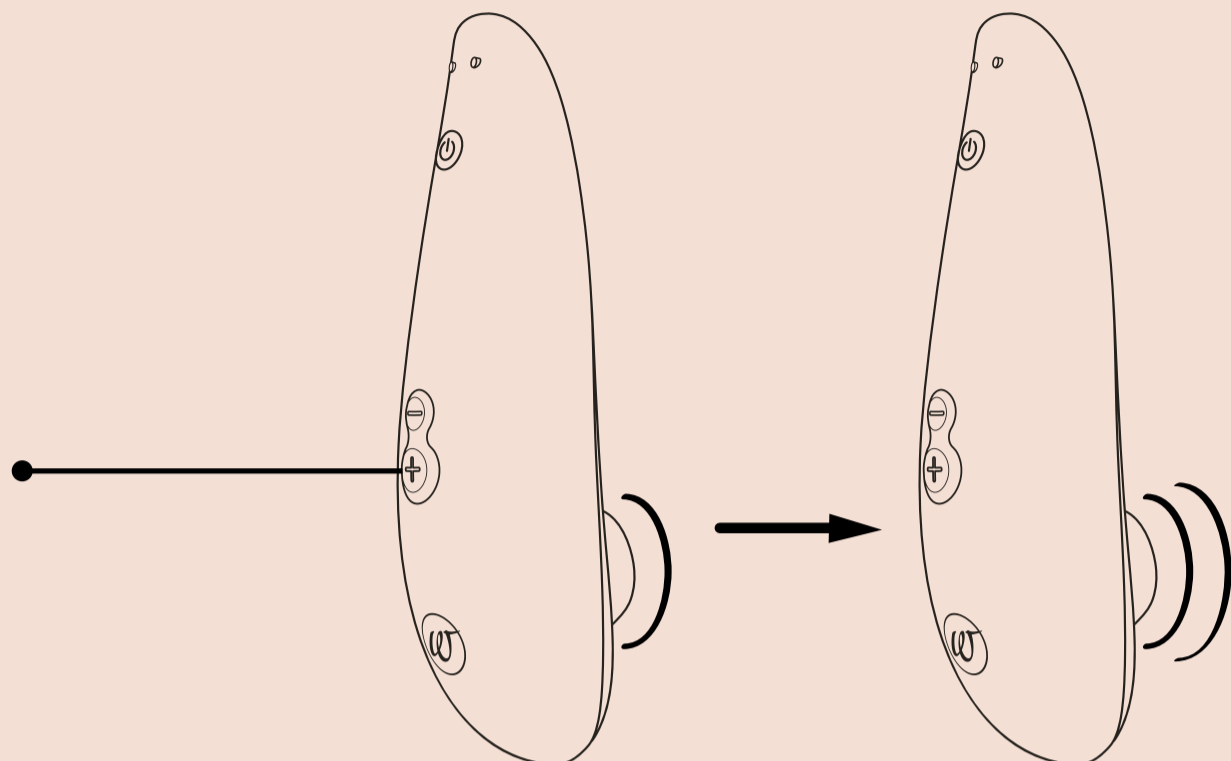

10  強度レベル

弱くする
軽く押します

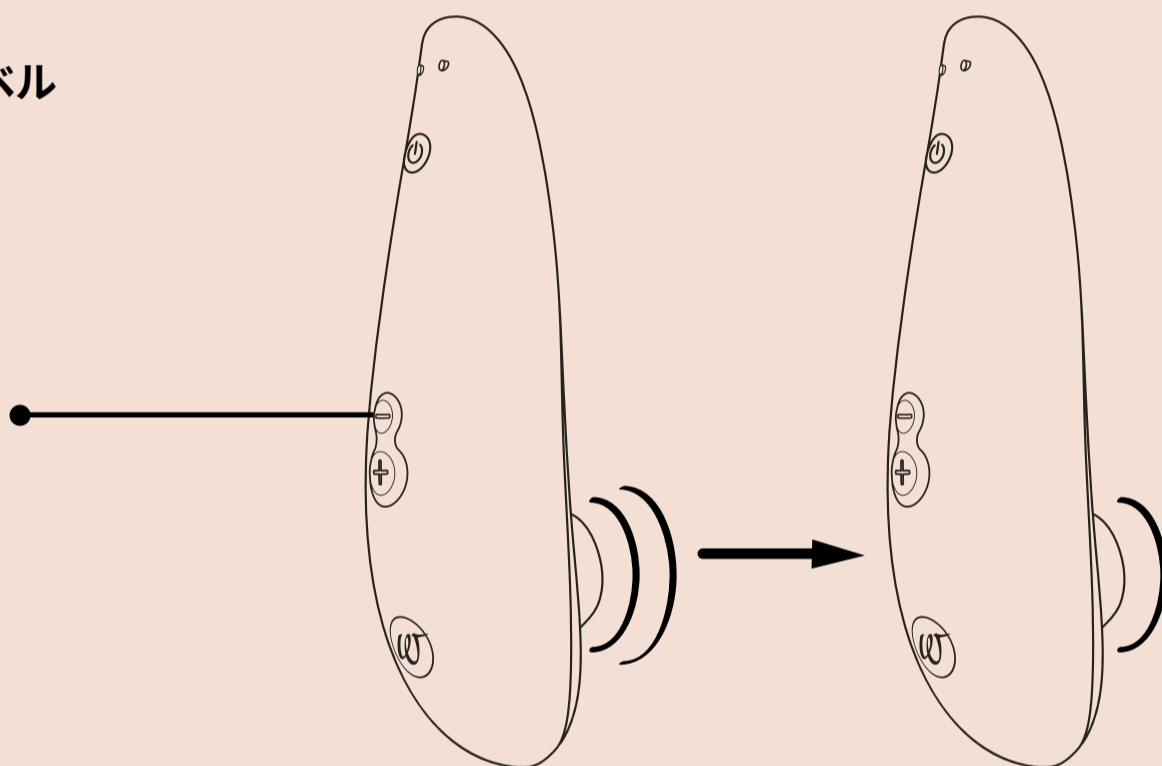

Afterglow 機能: 電源ボタンを軽く押し、強度レベルを 1 に戻します。

4.電源を切る

スイッチを
2 秒間押します

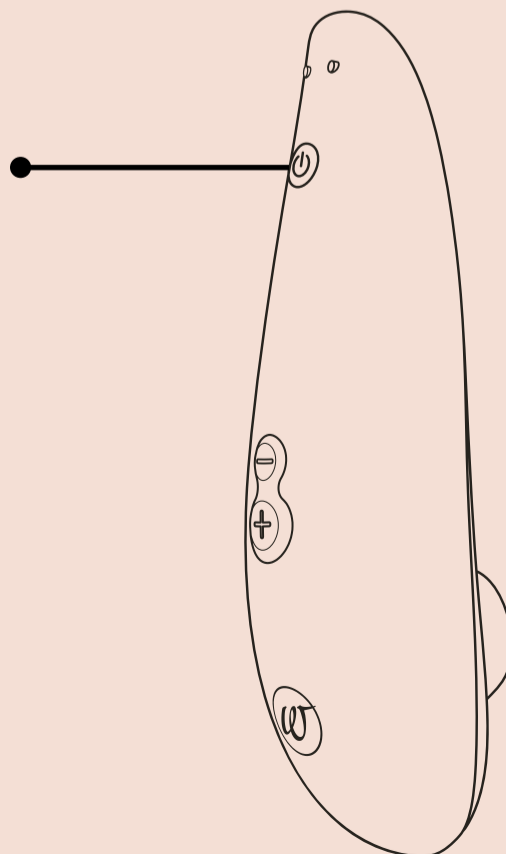

充電

Womanizer を初めて使用する前に、充電してください。バッテリーの寿命をできるだけ長く保つため、デバイスは、定期的に充電してください。

充電

USB ポート

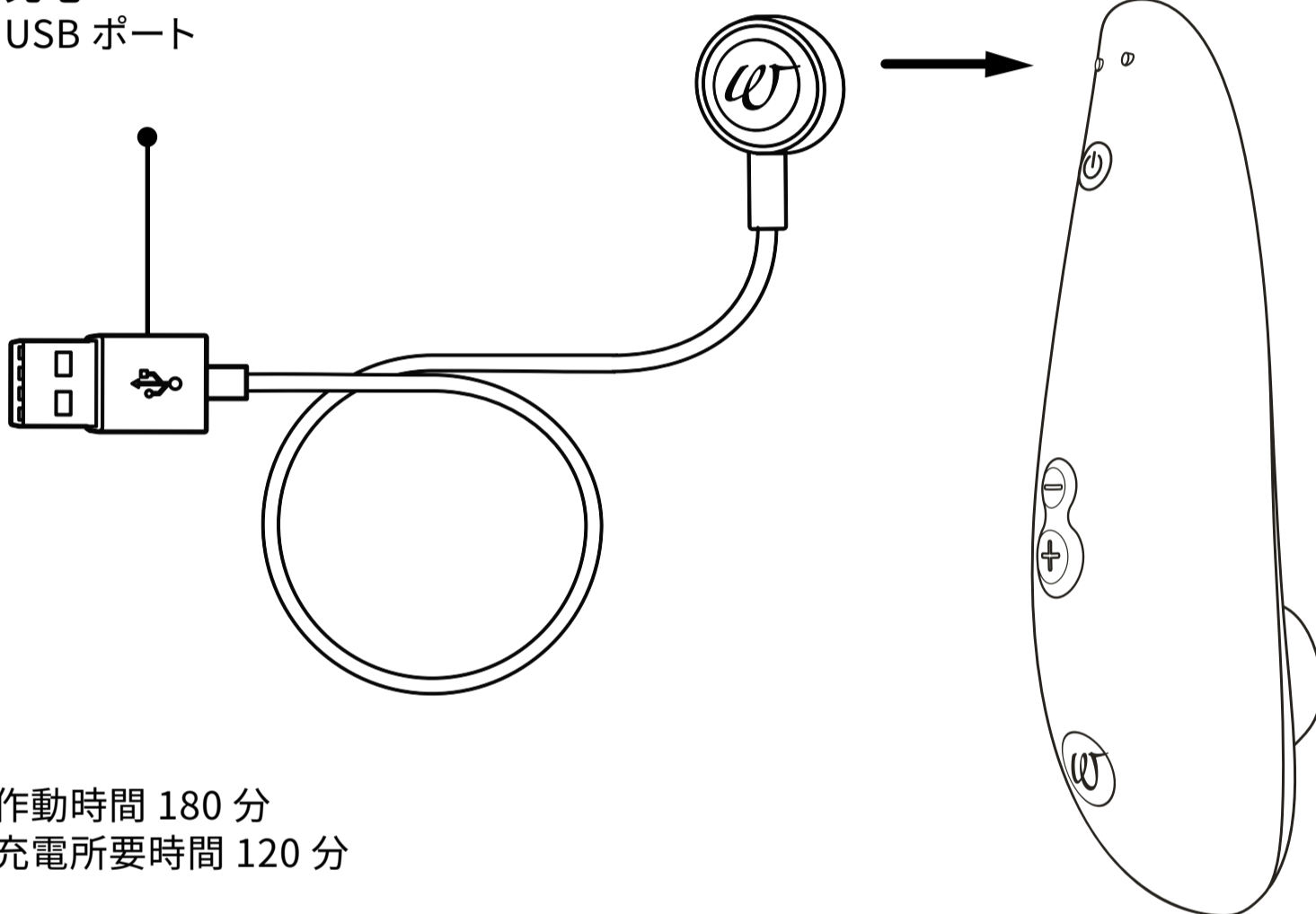

作動時間 180 分

充電所要時間 120 分

LED 電源ボタン

バッテリー レベル

フル充電

LED ライトが継続的に点灯します

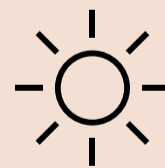

半充電

LED ライトが素早く点滅します

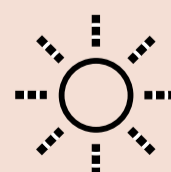

充電切れ

LED ライトがゆっくりと点滅します

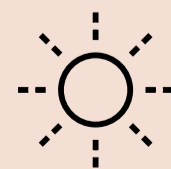

お手入れ

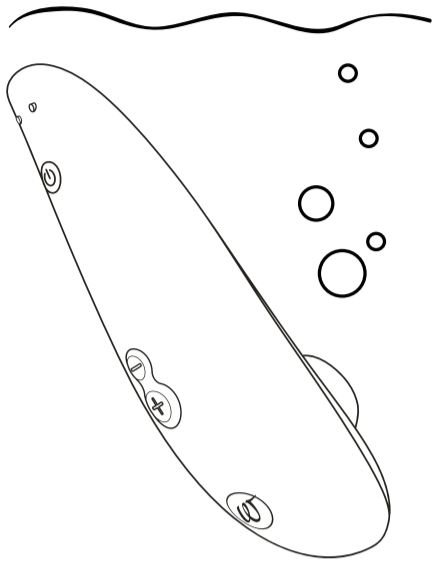

流水ですすぎ洗いしてください

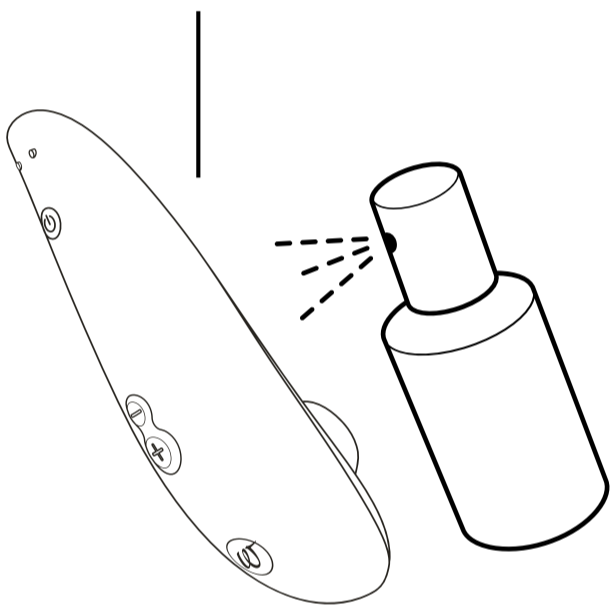

トイクリーナーを使用します

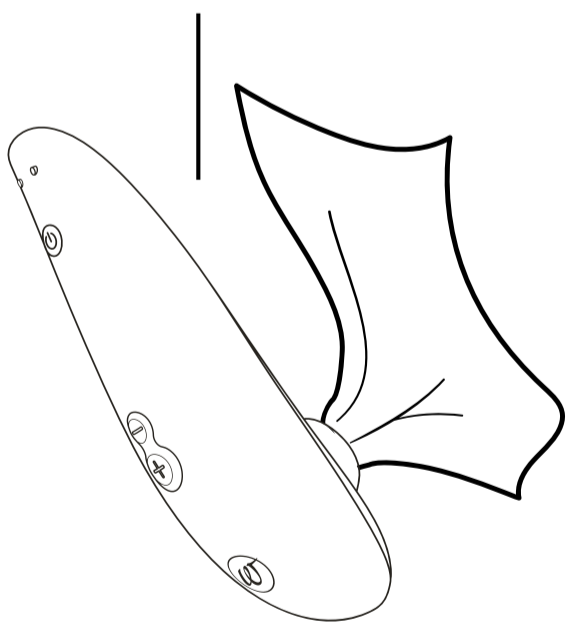

乾燥させます

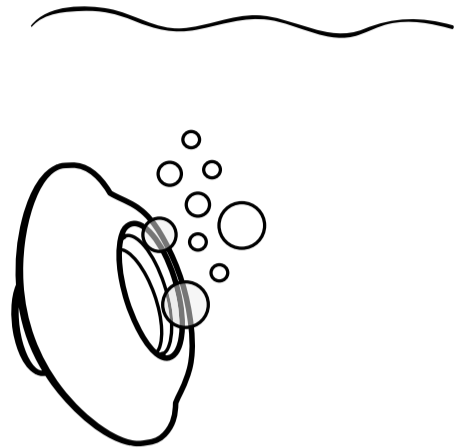

流水ですすぎ洗いしてください

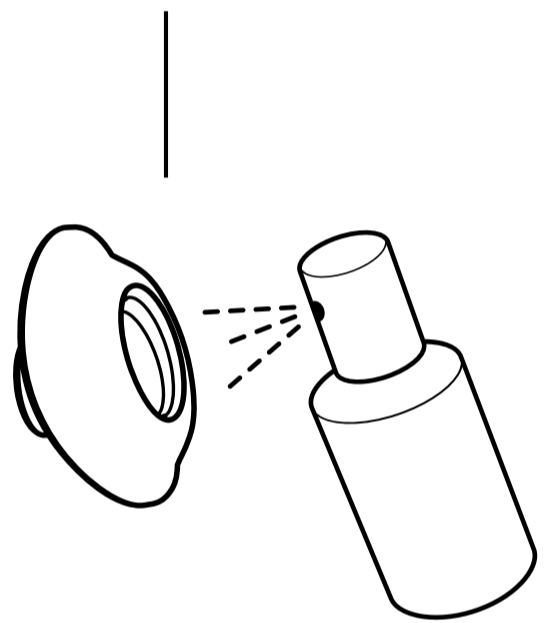

トイクリーナーを使用します

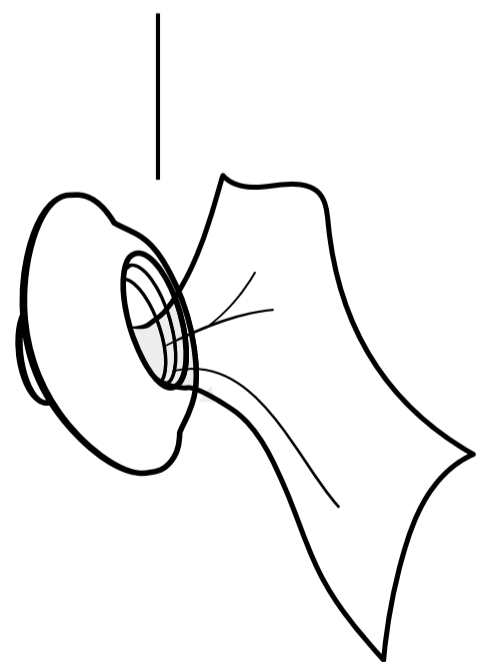

乾燥させます



Waterproof
IPX7

一般情報

警告

安全に関する指示をよく読み、詳細事項を確認してください。
初めて Womanizer を使用する前に、しっかりと洗浄してください。また、感染症のリスクを減らすため、使用後は必ず、洗浄してください。

カスタマーケア

詳細情報は、当社ウェブサイト www.womanizer.com を参照するか、care@womanizer.com までお問い合わせください。

技術仕様書

モデル: WZ08B
電力定格: 100-240 V ~ 50/60 Hz
出力: 5 V = 0.75 A
リチウムイオン充電電池を使用しています。
AC/DC アダプターは、含まれていません。

製品内容

Womanizer Classic 2、USB 充電ケーブル、コットンポーチ、スティミュレーションヘッド 2 個、クイックスタートガイド、安全に関する指示

保管

直射日光のあたらない、安全で乾いた場所に保管してください。

法定保証およびメーカー保証

WOW TECH EUROPE GMBH では、販売者が消費者に対して実施する必要がある法定保証に加え、独自のメーカー保証を提供しています。
メーカー保証の条件は、当社ウェブサイトの「保証条件」に、記載されています。

基準

この保証は、電磁両立性 (EMC) に関する全ての基準に、準拠しています。デバイスは、当ユーザーマニュアルの指示に従い、適切に使用する限り、安全です。

環境保護

電子機器販売業者として、当社には、使用済みの電子機器廃棄物を、無料で引き取る法的義務が課せられています。そして、ユーザーであるお客様には、使用済みバッテリーを返却する義務が課せられています。ご注意ください。電子機器やバッテリーは、家庭ごみとして捨てないでください。
当社の電子アイテムに下記のシンボルが施されている場合は、家庭ごみとしての廃棄ができないことを意味しています。

製造元

WOW Tech Europe GmbH,
Friedenstrasse 91 / 91 a, 10249 Berlin,
Germany

WOW Tech Europe GmbH は、デバイスを改良することを目的とした技術的変更、およびデザインの変更を行う権利を、保持しています。

北米担当販売代理業者: 1545 Carling Avenue, Suite 401, Ottawa ON, Canada K1Z 8P9

www.wowtech.com デザイン: ドイツ製
2021年中国製、マニュアル発行日: 02/2021
バージョン 1

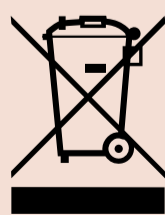

もっと知りたくなりましたか？

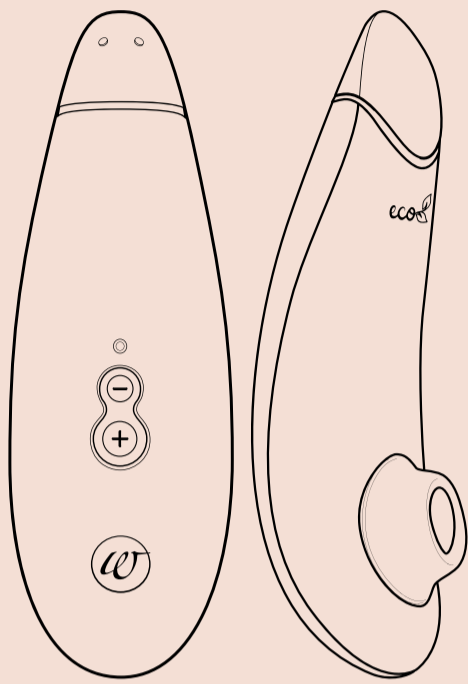

**Pleasure Air
Technology**



Smart Silence



Eco-friendly

Premium eco 

Loving Our Planet Can Be Orgasmic

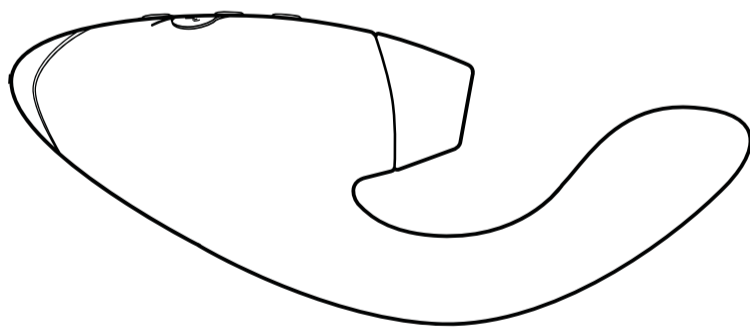

**Pleasure Air
Technology**



Vibrator



Smart Silence

DUO

Double your Pleasure

www.womanizer.com



#IMASTURBATE